

MICROSTRUCTURAL EVOLUTION DURING FRICTION STIR WELDING OF AlSi1MgMn ALLOY

Received – Prispjelo: 2010-12-21

Accepted – Prihvaćeno: 2011-02-10

Original Scientific Paper – Izvorni znanstveni rad

This paper provides the research of the influence of geometric and kinematic parameters on the microstructure and mechanical properties of welded joint of aluminum alloy AlSi1MgMn (6082-T6) obtained through the Friction Stir Welding (FSW) process. The experiment parameters were welding speed, rotation speed, angle of pin slope, pin diameter and shoulder diameter. On the obtained welded workpieces the dynamic testing on the impact toughness, and determination of microstructural zones were carried out.

Key words: friction stir welding - FSW, shoulder, pin, impact toughness, microstructure

Mikrostrukturni razvitak AlSi1MgMn slitine tijekom zavarivanja trenjem. U radu se istražuje uticaj geometrijskih i kinematskih parametara na mikrostrukturu i mehanička svojstva zavarenog spoja od aluminijske slitine AlSi1MgMn (6082-T6) dobivene postupkom zavarivanja trenjem (ZT). Parametri provedenih pokusa su brzina zavarivanja, kutna brzina okretanja alata, kut nagiba trna, promjer trna i promjer čela alata. Kod dobivenih zavarenih uzoraka izvedena su dinamička ispitivanja na udarnu žilavosti i određene su mikrostrukturne zone.

Ključne riječi: zavarivanje trenjem - ZT, čelo alata, trn, udarna žilavost, mikrostruktura

INTRODUCTION

Tools used in the FSW process are cylindrical and consisted of two concentric parts, which rotate at high speed. Part of the tool with larger diameter is called the shoulder, while the part with smaller diameter is called the pin. Tool and workpieces that are welded are shown in Figure 1 [1-4].

AlSi1MgMn alloy belongs to the group hardly welded alloys by conventional methods due to poor hardening and high porosity in the welding zone, so the effect occurs due to dissolution and coarsening of hardening phases. For that reason, welding of aluminum alloy us-

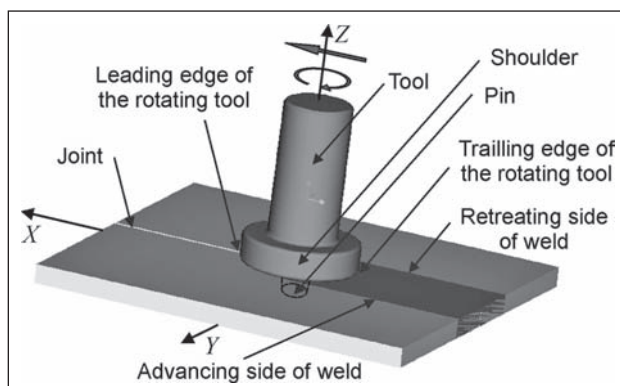

Figure 1 Scheme of FSW process

M. Janjić, M. Vukčević, N. Šibalić, Faculty of Mechanical Engineering, University of Montenegro, Podgorica, Montenegro. V. Mandić, Mechanical Engineering Faculty, University of Kragujevac, Kragujevac, Republic of Serbia. D. Pavletić, Faculty of Engineering, University of Rijeka, Rijeka, Croatia

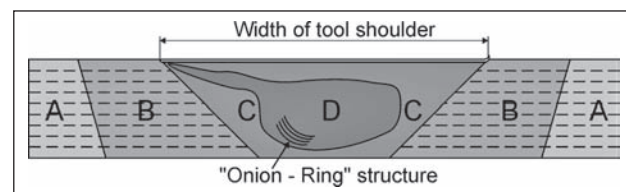

Figure 2 Various microstructural regions in the transverse cross section of friction stir welded material. A - unaffected material or parent metal, B - heat affected zone - HAZ, C - thermo-mechanically affected zone - TMAZ, D - "weld nugget" zone - NZ [1]

ing Friction Stir Welding process represents a major challenge for researchers.

Microstructural delineation of the four zones of the cross section of welded joint is shown in Figure 2 [1].

EXPERIMENTAL PROCEDURE

In order to determine the influence of geometric parameters of the tool on the microstructural changes and the impact toughness, the experimental research of welding of aluminum alloy AlSi1MgMn, thickness of 7,8 mm was carried out. The family of tools where geometrical parameters were varied was adopted for welding of aluminum alloy sheet. The general image of the family of tools for the FSW process is shown in Figure 3.

Based on preliminary researches, the multifactor orthogonal plan with varying of factors on two levels, and repetition in the central point of plan $n_0=4$ times is adopted. For input values, factors of the welding regime are adopted: $X_1=v$ mm/min (welding speed), $X_2=\omega$ rpm

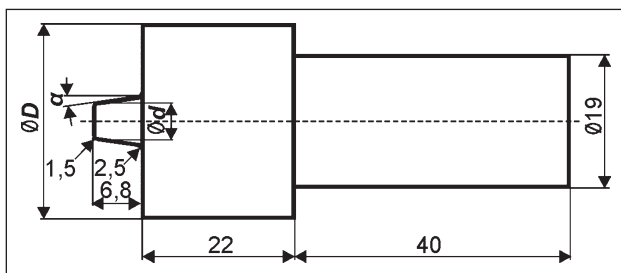

Figure 3 Tool with accepted dimensions and parameters D , d and α

(rotation speed of tool) and geometrical factors of tools: $X_3 = \alpha^\circ$ (angle of pin slope), $X_4 = d$ mm (diameter of the pin) and $X_5 = D$ mm (diameter of the shoulder). Levels of variation of input factors are adopted and given in Table 1 [3].

Table 1 Levels of variation of input factors [3]

Input factors	Upper level	Lower level	Basic level
X_1	200	80	125,00
X_2	1 000	630	800,00
X_3	5	3	3,87
X_4	7	5	5,92
X_5	28	25	26,46

Based on the adopted values of X_3 , X_4 and X_5 , the set of nine tools is made, and shown in Figure 4.

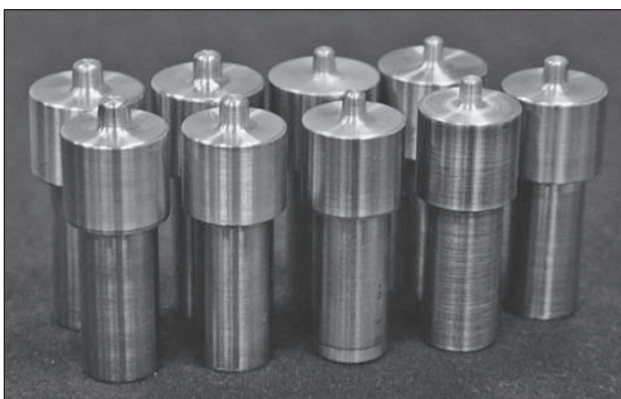

Figure 4 Set of tools made according plan of experiment

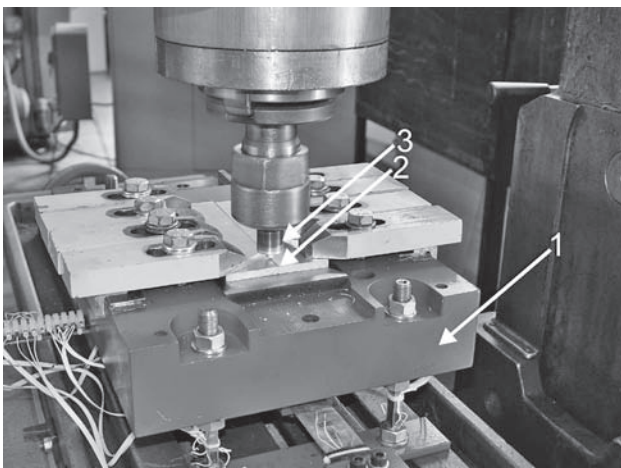

Figure 5 Research site: 1 - auxiliary equipment, 2 - workpieces of aluminum alloy AISi1MgMn, 3 - tool for FSW



Figure 6 Welded workpieces [3]

The process of conducting the experimental researches is shown in Figure 5, and Figure 6 presents the welded workpieces for the 36th point of the experimental plan.

DETERMINATION OF THE IMPACT TOUGHNESS

The welded joint obtained by using FSW process presents a complex and heterogeneous structure and the critical place in the welded workpiece, when it comes to industrial use in welded construction. Therefore, in most cases, the safety of welded joints or welded structures is determined according to the mechanical properties of welded joint, for that reason the paper includes the dynamic impact testing and determination of impact toughness of the material ρ . Sampling of the welded workpieces was performed. Specimens are cut from the direction normal to the direction of welding, y - transverse direction, so that all microstructural zones are located on the tested specimen.

Toughness testing of welded material is performed by impact load on the Charpy pendulum, with a maximum initial available energy of 150 J.

When impact occurs, the specimen is exposed to bending. The toughness of the welded material and shock resistance in bending is the work spend to break the specimen reduced to a unit of the specimen cross section:

$$\rho = \frac{F}{A} \text{ J/cm}^2 \quad (1)$$

The specimen was made according to standards MEST EN 10045-1:1993 [5], (Figure 7). A narrow specimen with a V-notch was adopted.

The value of energy consumed for the fracture of the specimen made of unaffected material is 42 J and impact toughness is $\rho = 70 \text{ J/cm}^2$.

The minimum values of impact toughness occur in the 17th and 18th point of the experimental plan: $\rho_{17} = 13,33 \text{ J/cm}^2$ and $\rho_{18} = 10 \text{ J/cm}^2$. The greatest value of impact

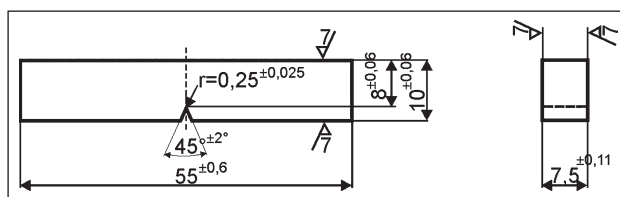

Figure 7 The specimen for testing of the impact toughness [5]

toughness is obtained for the central point or the 35th point of experimental plan: $\rho_{35} = 66,66 \text{ J/cm}^2$. All obtained values of impact toughness are lower than values obtained by the unaffected material, which is $\rho_{om} = 70 \text{ J/cm}^2$.

DETERMINATION OF MICROSTRUCTURAL ZONES

The process of metallographic, mechanical specimens preparation is done through a series of successive operations: cutting (sampling), roughing, mounting, grinding and polishing.

Chemical analysis of specimens obtained from cuts of workpieces welded by FSW process, is carried out with the appropriate reagent. The reagent is prepared by measuring of 1,3 ml 40 % HF hydrochloric acid in the gauge and gently mixed with 200 ml of distilled water into a suitable glass container. In this way, the reagent is ready for use.

Figure 8 shows the specimen for 28th point of the experimental plan, which is chemically treated and ready for testing.

Examination of macrostructure and microstructure is carried out by methods of light microscopy. Microstructural images of specimens are recorded on the metallographic microscope by inverse-type brands "METAVAL" optics "CARL ZEISS JENA" featured with "SAMSUNG" camera, model BW-4302. Figure 9 shows the metallographic microscope with camera, and recording patterns of the specimen. Metallographic microscope has the ability to zoom up to 500 times, and the camera has the ability to record up to 750 times of magnification.

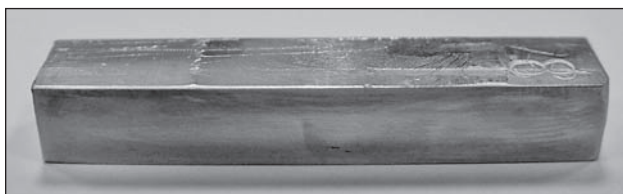

Figure 8 Display of the treated specimen for point of the experimental plan No. 28

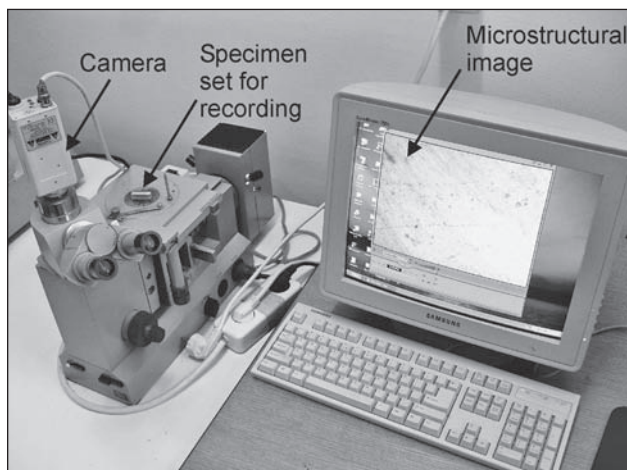

Figure 9 Metallographic microscope used to capture the structure of welded joints

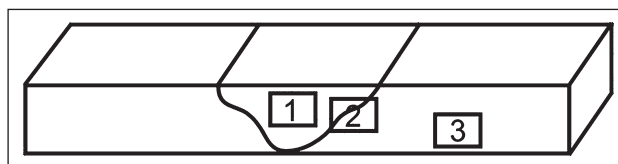

Figure 10 Scheme of microstructural analysis

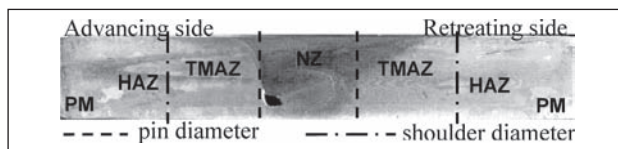

Figure 11 Macrostructure of the specimen No. 1

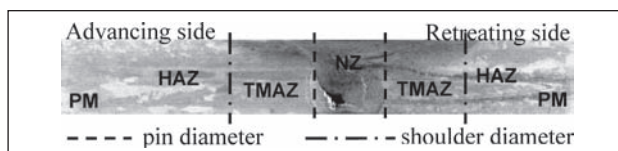

Figure 12 Macrostructure of the specimen No. 30

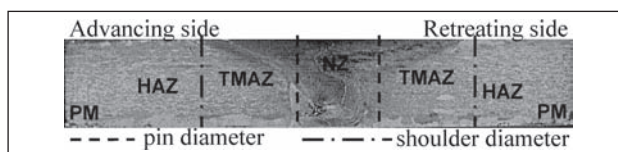

Figure 13 Macrostructure of the specimen No. 36

Method of light microscopy was used for providing recordings for all specimens, for all points of the experimental plan in elected positions. The aim of metallographic research is to identify the various defects that occur during the FSW, as well as the identification of microstructural changes.

Figure 10 shows the pattern of microstructural analysis harmonized with international researchings of FSW processes, and Figures 11, 12 and 13 shows the macrostructure of the specimen with the positions of microstructural zones.

Characteristic structural zones of FSW can be clearly identified from recorded images of macrostructure, those zones are: unaffected material or parent metal, heat affected zone - HAZ, thermo-mechanically affected zone - TMAZ, and so called "weld nugget" zone - NZ. The images clearly show defects that are present for certain points of the experimental plan. That is so called "tunnel" effect on the advancing side, as a result of insufficient transport material around the pin. This defect is one of the density errors, which can be detected by radiographic images, which are mostly incessant. This error can be avoided by proper choice of geometrical parameters of tools and kinematic parameters of the process.

Based on the macrostructure images for certain specific positions, images of microstructure are recorded, which provide a clearer view of the observed structure of welded joints, as well as the grain size.

Figure 14 shows the microstructure of the unaffected material.

Figure 15 shows the microstructure of heat affected zone - HAZ, while figure 16 shows the microstructure of the transition between the heat affected zone and the

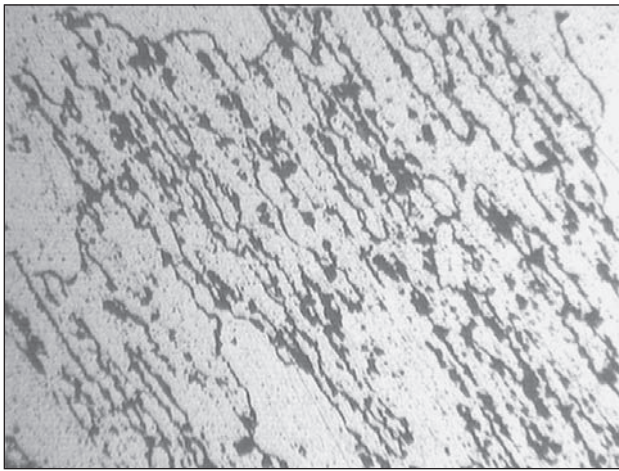

Figure 14 Microstructure of the unaffected metal
x 300

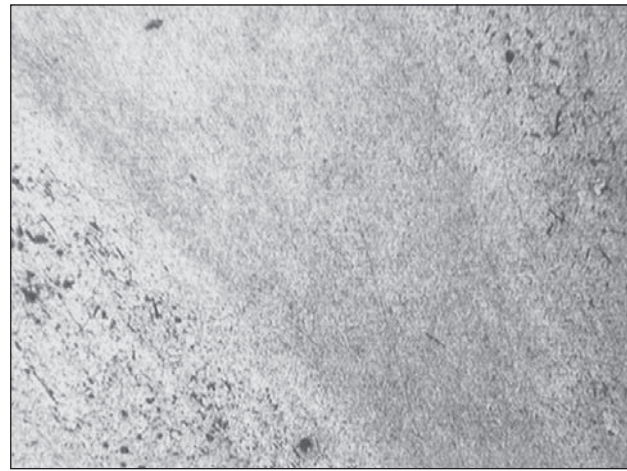

Figure 16 The microstructure of HAZ - TMAZ
x 100

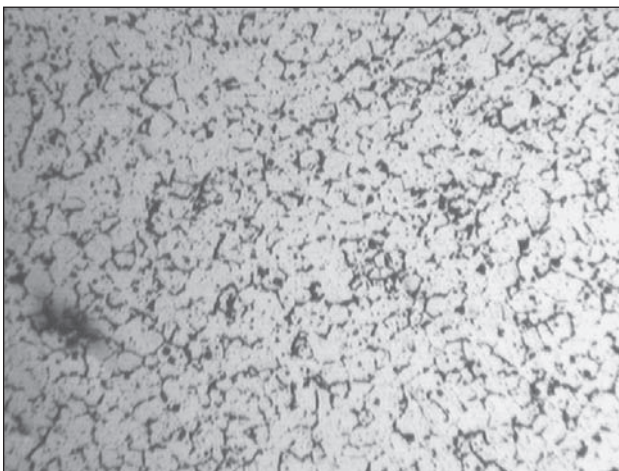

Figure 15 HAZ microstructure
x 200



Figure 17 Microstructure of the "weld nugget" zone
x 100

zone of thermo-mechanical effects for the center point of the experimental plan No 35.

When examining the microstructure, one can clearly identify the transition between the zone that was affected with deformation from tools and the unaffected material zone. The material which was deformed by FSW process, shows a well-turbulent grain structure, as well as materials in the vicinity of the heat affected zone - HAZ, which gives the proper arrangement of grains. In the mixing zone, a very fine recrystallized grains are present, due to the large deformation of material and high temperature during the FSW process. Microstructures within the "weld nugget" zone indicates dynamic recrystallized grains, which are much smaller than with the unaffected material, where the larger size grains are present. Dynamic recrystallized "weld nugget" zone is shown in Figure 17, for the center point of the experimental plan No 35.

In the heat affected zone - HAZ oriented grains are also present, which are assumed to be caused by the influence of residual stress from the process of FSW.

Thermo-mechanical affected zone - TMAZ depends on the size of the shoulder diameter and it is delineated with a "dot - dash" line in Figures 11, 12 and 13.

In the center of the stirred zone the "weld nugget" zone occurs, or a mixture of materials from two workpieces of aluminum alloy 6082-T6. This zone is easily identified. It is delineated with the "dotted" line in Figures 11, 12 and 13. This is the zone which suffered the greatest deformations and it is distinguished by fine-grain recrystallized materials from other zones, namely that is the zone where the pin has passed.

Details of the structure caused by the pin rotation should be observed in all specimens. The details are presented in Figure 18.

CONCLUSIONS

FSW welding process is relatively new and current technology. It is characterized by complex processes that take place in the welding zone, conditioned with the effects of many influential and interrelated factors, such as tool geometry, welding regime factors (kinematic factors), the properties of materials to be welded etc.

The experimental researches carried out successful welding of aluminum alloys AlSi1MgMn with the thickness of 7,8 mm, using the FSW process and it was de-



Figure 18 Microstructure of specimen No. 9, resulted after the influence of the pin

terminated that the quality of weld depends greatly upon tool dimensions (shoulder diameter, pin diameter, and the angle of the pin slope) as well as regimes of welding (welding speed and rotation speed).

When testing the impact toughness, the smallest values are obtained with specimens where the “tunnel” effect is present, and all obtained values of impact toughness are smaller than the values obtained by testing the unaffected material. Based on performed analysis, we may conclude that the best impact toughness values are obtained in the central points of the experimental plan.

Testing the macrostructure of FSW specimens, the existence of several microstructural zones was determined: Unaffected Material Zone, Heat Affected Zone - HAZ, Thermo-Mechanically Affected Zone - TMAZ and “Nugget” Zone - NZ. Microstructure obtained on advancing and retreating side are quite different: on the advancing side, the sharp border between the thermo-mechanically affected zone and stirred zone has appeared, and on the retreating side there is a continuous change between the two regions.

REFERENCES

- [1] R. Mishra, M. Mahoney: Introduction, Friction Stir Welding and Processing, R. Mishra, M. Mahoney (ured.), sv. 1, ASM International, 2007. str. 1-5.
- [2] T. Watanabe, H. Takayama, A. Yanagisawa: Journal of Materials Processing Technology, 178(2006), 342-349.
- [3] M. Vukcevic, M. Janjic, M. Plancak, N. Sibalic: Steel Research International, 81(2010)9, 1080-1083.
- [4] I. Kalemba, M. Kopyscianski, S. Dymek: Steel Research International, 81(2010)9, 1088-1091.
- [5] MEST EN 10045-1:1993. Mehanička ispitivanja metala - ispitivanje udarom po Šarpiju - Dio 1: Metoda ispitivanja.

Note: The responsible translator for English language is Aleksandra Mišurović, Podgorica, Montenegro