

POSSIBILITIES OF REMOVING LEAD FROM INDUSTRIAL Cu-Pb-Fe ALLOY WITH OF ARGON BARBOTAGE

Received – Prispjelo: 2008-06-22

Accepted – Prihvaćeno: 2008-12-02

Original Scientific Paper – Izvorni znanstveni rad

In this article results of research on removal of the lead from industrial Cu-Pb-Fe alloy by means of argon barbotage are presented.

The examinations was performed on an industrial alloy from the "Glogow II" Copperworks. As a basic research equipment a pipe resistance furnace enabling heating of a sample up to 1773 K temperature was used. All researches were conducted at 1473 K, 1523 K, 1573 K temperature and with gas flow $5,55 \times 10^{-6}$, $6,94 \times 10^{-6}$, $8,33 \times 10^{-6}$, $9,72 \times 10^{-6}$ m³/s.

Key words: metallurgy, lead barbotage, copper, removing.

Mogućnost uklanjanja olova iz industrijske Cu-Pb-Fe legure injektiranjem argonom. Članak daje rezultate istraživanja uklanjanja olova iz industrijske Cu-Pb-Fe legure primjenom injektiranja argonom. Opiti su provedeni na pogonskoj leguri u Tvornici bakra "Glogow II". Kao temeljna oprema rabljena je pećna cijev, koja omogućava zagrijavanje uzorka iznad temperature 1773 K. Sva istraživanja su provedena na temperaturama 1473 K, 1523 K, 1573 K i strujom plina $5,55 \times 10^{-6}$, $6,94 \times 10^{-6}$, $8,33 \times 10^{-6}$, $9,72 \times 10^{-6}$ m³/s.

Gljučne riječi: metalurgija, olovo, injektiranje, bakar, uklanjanje

INTRODUCTION

One of products of the single step copper smelting out of concentrate in fluidized-bed furnace in "Glogow" Copperworks is the slag containing up to 20 % wt. copper. This product is then submitted to a decopperizing process in electric furnace. As a product in this technology a Cu-Pb-Fe alloy containing over 20 % wt. of lead and the dusts containing up to 40 % wt. of this element is obtained [1, 2].

Cu-Pb-Fe alloy is processed in the converter to obtain a copper suitable for the fire refining process, i.e. containing below 0,3 % wt. of lead. At the same time, this technology is aimed at the removal of possible highest quantity of lead to dusts and the obtainment of low concentration of arsenic in copper. As result of this process, approx. 70 % wt. of lead contained in this alloy is passed to dusts, and the remaining part is collected in converter slag. Because the copper content in slag (even above 35 % wt.) is higher than that of lead, this material is returned back to electric furnace. It can be assumed then, that the lead contained in converter slag is circulating in the process cycle [1, 2].

EVALUATION OF MASS PENETRATION COEFFICIENT IN THE LIQUID AND GASEOUS PHASE

For calculation of mass penetration coefficient in liquid phase was taken the relationship was used:

$$\beta_c = 2 \cdot \sqrt{\frac{D_{\text{Cu-Pb}}}{t \cdot \pi}} \quad (1)$$

where: $D_{\text{Pb-Cu}}$ – diffusion coefficient of lead in liquid copper,
t – contact time of liquid phase with air bubbles.

and

$$\beta_c = 0,975 \cdot d_p^{-0,25} \cdot D_{\text{Cu-Pb}}^{0,5} \cdot g^{0,25} \quad (2)$$

where: d_p – bubble diameter,
g – gravitational acceleration.

To determine the mass penetration coefficient in liquid phase it is necessary to know the diffusion coefficient of lead in liquid copper. For these calculations the data from the work [3] (Table 1) were used.

As bubble diameter in calculations the arithmetic average of values obtained from relationships (3) and (4) was applied [4,5].

$$d_p = 0,54 \cdot (q \cdot d_w^{0,5})^{0,289} \quad (3)$$

where: d_p – bubble diameter,
 d_w – nozzle internal diameter,
q – gas flow intensity.

B. Oleksiak, Faculty for Metallurgy, Silesian Technical University, Katowice, Poland

Table 1. Change of diffusion coefficient of lead in copper depending on temperature.

Temperature /K	$D_{Pb-Cu} \times 10^8$ /m ² /s
1473	2,02
1498	2,14
1523	2,19
1548	2,25

$$d_p = \left\{ \left(\frac{6 \cdot \sigma_m \cdot d_z}{\rho_m \cdot g} \right)^2 + 0,0242 \cdot (q^2 \cdot d_z)^{0,867} \right\}^{\frac{1}{6}} \quad (4)$$

where: σ – surface tension of liquid metal,
 ρ_m – liquid metal density,
 d_z – nozzle external diameter.

For the determination of mass penetration coefficient in gaseous phase were used relationships:

$$\frac{\beta_g \cdot d_p}{D_{Pb-Ar,He}} \cong 6,6 \quad (5)$$

$$Sh = 2,05 \cdot Pe^{0,5} \quad (6)$$

To calculate the above mentioned coefficient it is necessary to know the *Pecklet* number, the value of which was defined from relation (7):

$$Pe = \frac{u_p \cdot d_p}{D_{i-g}} \quad (7)$$

For the calculation of mass penetration coefficient in gaseous phase is necessary to know the value of the diffusion coefficient of lead vapors in argon and helium. In Table 2 are assembled the values of diffusion coefficient depending on process temperature and determined in [6].

Table 2. Change of diffusion coefficient of lead vapors in gases depending on temperature.

Temperature /K	$D_{Pb-Ar} \times 10^4$ /m ² /s
1473	1,76
1498	1,80
1523	1,85
1548	1,93

Calculated from relations (1), (2), (5) and (6) the values of mass penetration coefficient in the liquid and gaseous phase are given in Table 3. In this table the values of mass transfer coefficient calculated from relation (8) are given [5].

$$\frac{1}{k} = \frac{R \cdot T}{\beta_g} + \frac{\alpha \cdot P_{Pb}^0 \cdot \gamma_{Pb}}{\beta_c} \quad (8)$$

where: k - mass transfer coefficient,
 β_c - mass penetration coefficient in liquid phase,
 β_g - mass penetration coefficient in gaseous phase,
 T - temperature,
 α - heat transfer coefficient.

Table 3. Coefficients of transfer and penetration of lead in liquid and gaseous phase.

Temp. /K	Flow intensity $q \cdot 10^6$, /m ³ /s	Mean value of penetration coefficient in liquid phase $\beta_c \cdot 10^4$ /m/s	Mean value of penetration coefficient in gaseous phase /m/s	Mass transfer coefficient k / mol·s ⁻¹ ·m ⁻²
1473	5,55	7,28	0,106	0,886
	6,94	7,17	0,104	0,855
	8,33	7,08	0,101	0,830
	9,72	7,00	0,098	0,810
1498	5,55	7,48	0,110	0,893
	6,94	7,36	0,106	0,862
	8,33	7,27	0,104	0,837
	9,72	7,19	0,100	0,817
1523	5,55	7,55	0,113	0,900
	6,94	7,44	0,109	0,869
	8,33	7,35	0,105	0,844
	9,72	7,27	0,104	0,824
1548	5,55	7,65	0,118	0,921
	6,94	7,54	0,114	0,889
	8,33	7,44	0,110	0,864
	9,72	7,36	0,108	0,843

R - gas constant,

P_{Pb}^0 -lead equilibrium pressure over pure bath.

In Figures 1 and 2 the variations of mass penetration coefficient in liquid phase and the mass transfer coefficient, in function of gas flow intensity are presented.

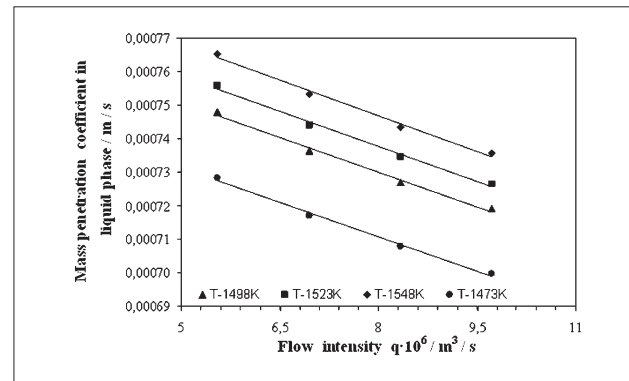

Figure 1. Change of mass penetration coefficient in liquid phase in function of gas flow intensity.

Considering the relation (8) and assuming that relation

$$\left(\frac{R \cdot T}{\beta_g} \right) : \left(\frac{1}{k} \right) = z \cdot 100\% \quad (8)$$

represents a contribution of mass transport resistance in gaseous phase in the total process resistance, it is shown that in analyzed range of temperatures, as well as in applied gas flows, the lead elimination process is determined by penetration of mass in gaseous phase. In all experiments the fraction of penetration resistance in

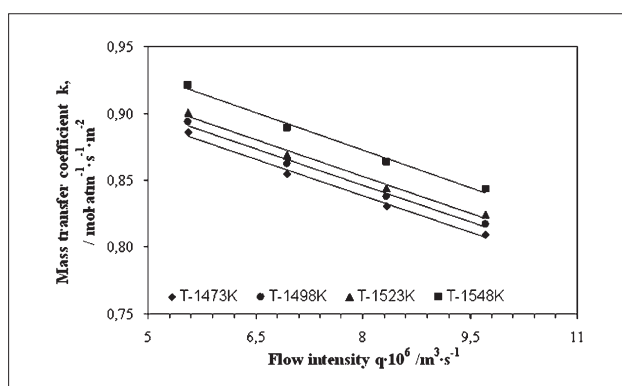

Figure 2. Change of mass transfer coefficient in function of gas flow intensity

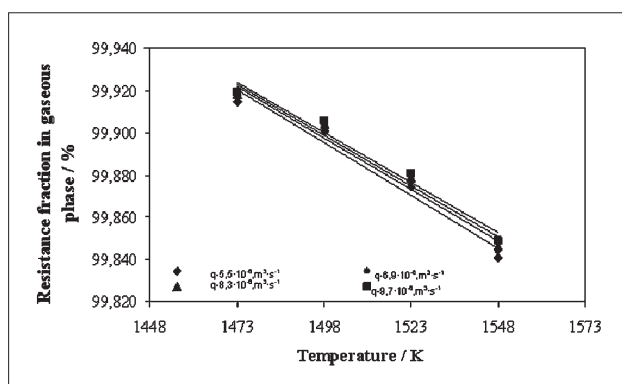

Figure 3. Resistance fraction in gaseous phase in the total resistance of lead evaporation process from Cu-Pb-Fe alloy.

gaseous phase had exceeded 99 %. This is illustrated by the data in Figure 3.

RESEARCH EQUIPMENT AND MATERIALS

The research work was made on industrial alloy Cu-Pb-Fe provided by „Glogow” Copperworks. The chemical composition of alloy used in examinations is presented in Table 4.

Table 4. Chemical composition of tested alloys.

Type of alloy	Contents of alloy basic parts / % wt.					
	Cu	Pb	Fe	As	S	Ag
Industrial alloy	70,4	21,5	2,9	3,3	1,7	0,0025

A sketch of equipment used in tests is showed in Figure 4. The main component was a pipe-type resistance furnace, enabling heating of sample up to 1773 K. In the furnace a ceramic protective retort accommodating the crucible with sample was placed. Measurement of process temperature was executed through the thermocouple Pt-PtRh10 of 0,006 m dia. placed directly in liquid alloy. The gas was introduced into metallic bath through an Al_2O_3 lance immersed to the depth 0,005 m over crucible bottom. Gas flow was controlled by manual valves and rotameters. Whole system was closed with a ceramic cover and asbestos seal.

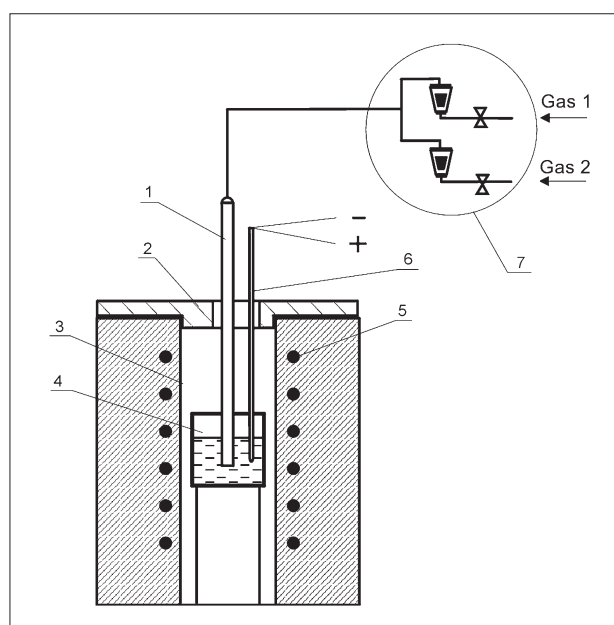

Figure 4. Sketch of equipment used in tests: 1 - lance, 2 - asbestos seal, 3 - ceramic shield, 4 - crucible with alloy, 5 - furnace heating components, 6 - thermocouple, 7 - gas supply system.

METHODOLOGY OF RESEARCH

A prepared alloy sample put in alundum crucible was introduced into ceramic retort placed in the furnace heated up to required temperature.

In the course of melting stage, an inert gas was introduced into working chamber through a lance located over crucible to protect the metal against oxidation. When a predetermined temperature was achieved in the furnace, a lance was introduced in and appropriate gas flow was adjusted. At the set time intervals the alloy specimens were sampled with use of quartz pipes. During this operation the flow of gas through metallic bath was uninterrupted and thus prevented a possibility of adverse metal delamination. Having completed the tests, the lance was withdrawn off the crucible, furnace supply was switched off and the system was cooled down blowing with inert gas. After withdrawal of the sample, the slag and metallic fractions were separated and the samples were weighed up. In case of metallic samples, they were wholly dissolved in appropriate solution of nitric acid and the solutions were analyzed with the help of atomic absorption spectrometer Unicam, model Solar M6.

All tests were conducted at 1473 K, 1523 K, 1573 K temperature and with gas flow $5,55 \times 10^{-6}$, $6,94 \times 10^{-6}$, $8,33 \times 10^{-6}$, $9,72 \times 10^{-6} \text{ m}^3/\text{s}$. In Table 5 are shown the basic test parameters for the different measurement series.

Measurement series are designated as follows: temperature at measurement – first three figures define the gas flow. For example, the test designation P-1473-5,55-1 means, that this examination relates to measurement series executed at 1473 K temperature, with argon flow $5,55 \times 10^{-6} \text{ m}^3/\text{s}$, test 1.

Table 5. Basic test parameters.

Applied gas	Process temp. /K	Gas flow, $q \cdot 10^6 / m^3/s$	Test duration / s	Sample weight /g
Ar	1473	5,55	28800	490 ± 10
	1523	6,94		
	1573	8,33		
		9,72		

TEST RESULTS

Test results of all experiments concerning final concentration of lead and its degree of removal from the liquid Cu-Pb-Fe alloy are presented in Table 6. In Figures 5 -7 are shown examples of variations of lead concentration depending on process duration time.

Table 6. Final concentrations of lead and its elimination degree achieved.

No	Test designation	Final concentration of lead in alloy / %wt.	Lead removal degree / %
1	P-1473-5,55-1	21,24	1,26
2	P-1473-5,55-2	21,30	0,98
3	P-1473-6,94-1	20,99	2,42
4	P-1473-6,94-2	21,02	2,28
5	P-1473-8,33-1	20,88	2,93
6	P-1473-8,33-2	20,86	3,02
7	P-1473-9,72-1	20,53	4,56
8	P-1473-9,72-2	20,49	4,74

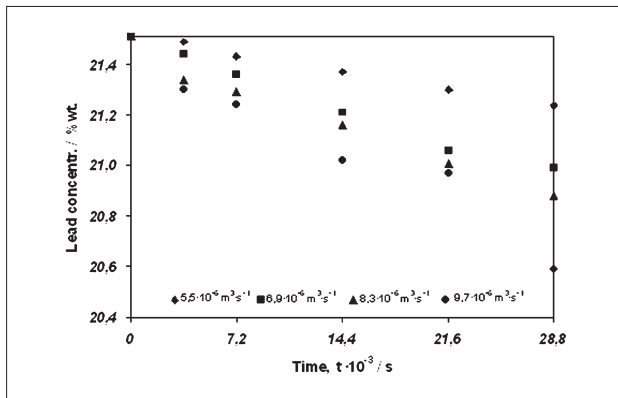

Figure 5. Variation of lead concentration in Cu-Pb-Fe alloy depending on process duration time (temp. 1473 K).

CONCLUSIONS

The results of tests and their analysis provide the grounds for the following conclusions:

- Process of lead removal from Cu-Pb-Fe alloy by means of barbotage with inert gases within analyzed range of temperatures and flow intensities of gas diffusion type controlled and is determined by the mass transport in gaseous phase. The penetration resistance in gaseous phase constitutes 99 % of total process resistance.

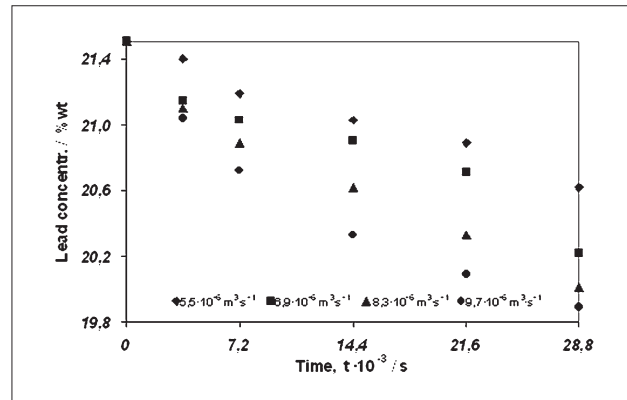

Figure 6. Variation of lead concentration in Cu-Pb-Fe alloy depending on process duration time (temp. 1523 K).

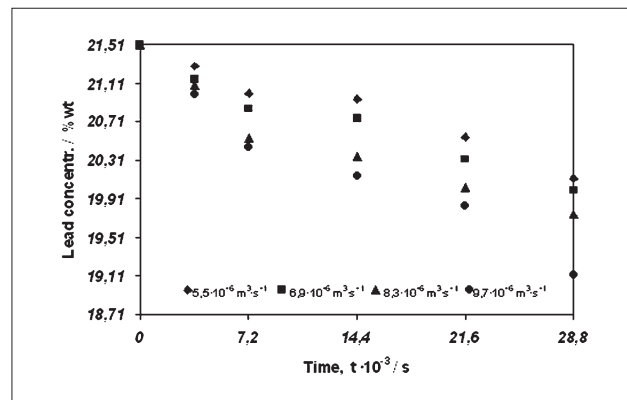

Figure 7. Variation of lead concentration in Cu-Pb-Fe alloy depending on process duration time (temp. 1573 K).

- The increase of gas flow intensity and temperature of the process will raise the degree of lead removal from tested alloys.
- The maximal degree of lead removal at the parameters adopted for tests was of 11,1%.
- Low speed of barbotage process would not allow to apply this technology as the first stage of converting Cu-Pb-Fe alloy. It is possible to use this technology as an auxiliary operation. Such operation can be applied in the second converting stage, when the lead content in copper is dropping to 2 %.

LITERATURE

- [1] A. Piestryński, A. Jasiński, J. Kotarski & others: Monograph KGHM Polska Miedź S.A., Cuprum Sp. z.o.o., Lublin, 1996.
- [2] M. Kucharski: Pyrometallurgy of Copper, Wyd. Nauk. – Dydakt., Kraków, 2003.
- [3] L. Blacha: Scientific Scripts of Silesian Technical University, Gliwice, 2001.
- [4] J. Botor: The Works of Institute of Non-Ferrous Metals, Supplement 7, (1978) 1.
- [5] K. Okumura, M. Ban: ISIJ Int., (1995), vol. 35, 832-837.
- [6] L. Blacha, B. Sikora, R. Sosnowski: Hutnik, (1992) 12, 384 – 387.

Note: The autor B. Oleksiak is responsible for English language.