

Optimized Second- and Fourth- Order LP and BP Filters

UDK 621.372.542:004.42
 IFAC 4.3.1

Original scientific paper

In this paper general second-order low-pass and band-pass filter sections are presented. The voltage noise spectral density and Schoeffler sensitivity are calculated for the simple design procedure and for three different types of optimization. The optimization procedure is also done for the forth-order low-pass and band-pass filter. The resulting low noise and sensitivity is investigated using the RMS noise voltage and multi-parameter sensitivity measure. The optimization gives lower noise and lower sensitivity filters. All analyzes are performed using Matlab and Spice programming tools.

Key words: Low-pass filter, Band-pass filter, Noise, Sensitivity, Optimization

Optimizirani NP i PP filtri drugog i četvrtog reda. U radu su prikazane opće filterske sekcije drugog i četvrtog reda. Izračunati su spektralna gustoća napona šuma i Schoefflerova osjetljivost i to za jednostavan proračun te za tri različita tipa optimizacije. Optimizacija je također provedena za nisko propusni i pojasno propusni filter četvrtog reda. Dobiiveni niski šum kao i osjetljivost ispitani su računanjem efektivne vrijednosti napona šuma i više-parametarske mjere osjetljivosti. Rezultati optimizacije daju filtre koji imaju manji šum kao i osjetljivost. Svi su proračuni izvedeni korištenjem programskih alata Matlab i Spice.

Ključne riječi: nisko-propusni filter, pojasno-propusni filter, šum, osjetljivost, optimizacija

1 INTRODUCTION

A design procedure of low sensitivity second-order low-pass (LP) and band-pass (BP) filters is presented in [1-6].

In this paper calculation of the values of filter elements will be applied in four different ways. Using the first and the simplest way, some additional parameters of filter, such as noise voltage spectral density and Schoeffler sensitivity figure, are not optimal. The operation of the filters with operational amplifiers (OA) can be better using some of the optimization procedures for minimizing RMS noise voltage parameter (E) and multi-parameter sensitivity measure (M). In the first step, the optimization will be done over noise criteria in way to calculate noise voltage spectral density and indicator E . After that, the optimization will be done over sensitivity in way to calculate Schoeffler sensitivity criteria and indicator M . Combining obtained results, a new optimization will be performed on the second-order LP and BP filters in order to satisfy as much as possible both criteria. Finally, the procedure of completed optimization will be done for the fourth-order filters realized as a cascade of two second-order sections.

Using Matlab and Spice programming tools the filter performances will be simulated and the noise and sensitivity will be investigated.

2 THE SECOND ORDER LP AND BP FILTER SECTIONS

The second order general LP and BP filter sections are shown in Fig. 1.

The transfer functions of the presented filter sections are

$$T_{LP}(s) = \frac{\left(1 + \frac{R_4}{R_3}\right) \frac{1}{R_{11}R_2C_1C_2}}{s^2 + s \left(\frac{1}{R_1C_1} + \frac{1}{R_2C_1} - \frac{R_4}{R_2R_3C_2}\right) + \frac{1}{R_1R_2C_1C_2}} \quad (1)$$

for the LP filter and

$$T_{BP}(s) = \frac{-\left(1 + \frac{R_3}{R_4}\right) \frac{1}{R_{11}C_1} s}{s^2 + s \left(\frac{1}{R_2C_1} + \frac{1}{R_2C_2} - \frac{R_3}{R_1R_4C_1}\right) + \frac{1}{R_1R_2C_1C_2}} \quad (2)$$

for the BP filter.

2.1 Noise Analysis

Noise model of operational amplifier is presented in [7, 8]. Transfer functions are calculated from

$$T_X(s) = \frac{V_{OUT}}{N_X} \quad (3)$$

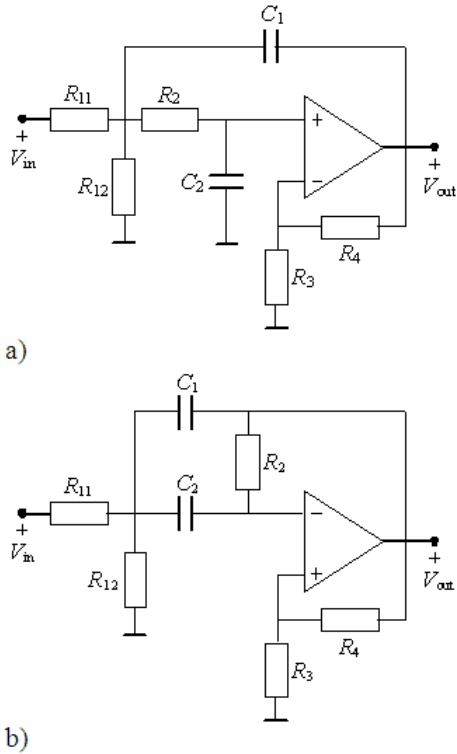

Fig. 1. The 2nd order; a) LP, b) BP filter section

where N_X is either voltage or current noise source of element x . The RMS noise voltage E_n for specified frequency range is calculated with

$$(E_n^2)_{ef} = \int_{\omega_1}^{\omega_2} V_n^2(\omega) d\omega \quad (4)$$

where $V_n^2(\omega)$ is

$$V_n^2(\omega) = \sum_{k=1}^m |T_{i,k}(j\omega)|^2 (I_n)_k^2 + \sum_{l=1}^n |T_{v,l}(j\omega)|^2 (V_n)_l^2 \quad (5)$$

The last equation gives the square of the noise spectral density derived from all noise sources, where $T_{i,k}(j\omega)$ is a transfer impedance, i.e. a ratio of output voltage and input current of k -th current noise source $(I_n)_k$, $T_{v,l}(j\omega)$ is a voltage transfer function, i.e. a ratio of the output voltage and input voltage of l -th voltage noise source $(V_n)_l$. Through noise voltage spectral density and RMS noise voltage, noise effects can be observed.

2.2 Sensitivity Analysis

Sensitivity analysis method is given in [9, 10]. Influence of the variation of elements x_i to the filter amplitude response $|T(j\omega)|$ is analyzed. The sensitivity function S is defined as follows

$$S_{x_i}^{|T(j\omega)|} = \frac{d|T(j\omega)|}{dx_i} \cdot \frac{x_i}{|T(j\omega)|} \quad (6)$$

If the gain amplitude response is defined in dB units as

$$\alpha(\omega) = 20 \log |T(j\omega)| \quad (7)$$

then the gain sensitivity function can be defined with

$$S_{x_i}^{\alpha(\omega)} = x_i \frac{d\alpha(\omega)}{dx_i} [dB] \quad (8)$$

The Schoeffler sensitivity function $I_s^2(\omega)$ used for sensitivity measure is defined by relation

$$I_s^2(\omega) = \sum_i (S_{x_i}^{\alpha(\omega)})^2 \quad (9)$$

The multi-parameter sensitivity measure is defined by relation

$$M = \int_{\omega_1}^{\omega_2} \sum_i (S_{x_i}^{|T(j\omega)|})^2 d\omega \quad (10)$$

2.3 Optimization Procedure

The simplest way for calculating filter elements values is to set

$$C_1 = C_2 \text{ and } R_1 = R_2 \quad (11)$$

From given filter parameters: poles frequency, poles Q-factor and gain, all the elements can be calculated straightforward.

LP:

$$\omega_p = \sqrt{\frac{1}{R_1 R_2 C_1 C_2}},$$

$$Q_p = \frac{\sqrt{\frac{R_2 C_1}{R_1 C_2}}}{1 + \frac{R_2}{R_1} - \frac{R_4 C_1}{R_3 C_2}},$$

$$k_A = \frac{R_1}{R_{11}} \left(1 + \frac{R_4}{R_3} \right) \quad (12)$$

BP:

$$\omega_p = \sqrt{\frac{1}{R_1 R_2 C_1 C_2}},$$

$$Q_p = \frac{\sqrt{\frac{R_2 C_1}{R_1 C_2}}}{1 + \frac{C_1}{C_2} - \frac{R_2 R_3}{R_1 R_4}},$$

$$k_A = \frac{1}{R_{11}} \left(\frac{1}{R_3} + \frac{1}{R_4} \right) C_2$$

$$= \frac{1}{R_2 R_3} (C_1 + C_2) - \frac{1}{R_1 R_4} C_2 \quad (13)$$

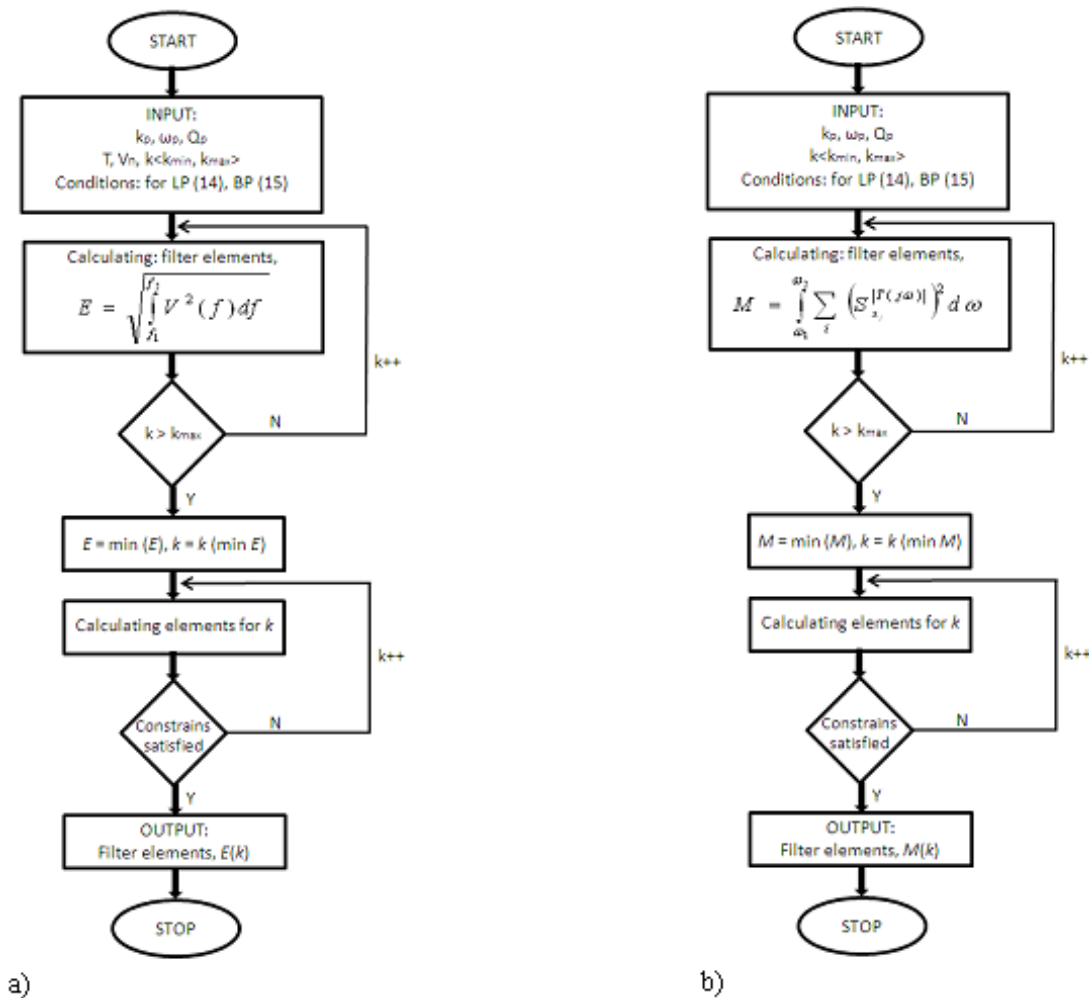

Fig. 2. Block-diagram for obtaining filters elements for; a) minimum noise, b) minimum sensitivity

Using

$$LP : C_2 = k \cdot C_1 \text{ and } R_1 = R_2 \quad (14)$$

$$BP : R_2 = k \cdot R_1 \text{ and } C_1 = C_2 \quad (15)$$

filter’s responses are not changed but some other properties, such as here observed noise and sensitivity are different. In case where the LP filter is observed, (14) is chosen because of highest influence of element C_2 to the Schoeffler sensitivity function. Analog with it, (15) is used for the BP filter. Now, the main problem is to define parameter k which will give minimal noise and/or minimal sensitivity. The problem is solved using numerical methods due to complexity of analytic expressions. Fig. 2 presents block diagrams of the optimization procedures.

2.4 Example

For example, a second order LP and BP Chebyshev filters, with 4 kHz cut-off frequency for LP and 4 kHz cen-

tral frequency for BP filter are realized. Numerical method for calculating the best k in (14) and (15) which gives minimal noise and/or sensitivity is an iterative procedure. Constrains for calculated elements are positive values for passive elements and resistors in range $200 \Omega \leq R_i \leq 500 \text{ k}\Omega$. The goal is to find k which gives minimal E from (4) for the noise minimization and/or minimal M from (10) for the sensitivity minimization, considering previously set constrains. Obtained results are shown in Fig. 3 and 4.

Observing Fig. 3 it is obvious that in case of LP filter the noise will be lower as factor k is lower, but the lowest k gives negative elements. To satisfy set constrains, $k = 0.66$ is chosen. For the BP filter the minimum of the optimization is obtained for $k = 2.55$.

In sensitivity optimization for the LP filter factor k is identical as previous ($k=0.66$). The value of k chosen in order to obtain minimum function in Fig. 4a gives negative elements. For the BP filter the result is different. Sensi-

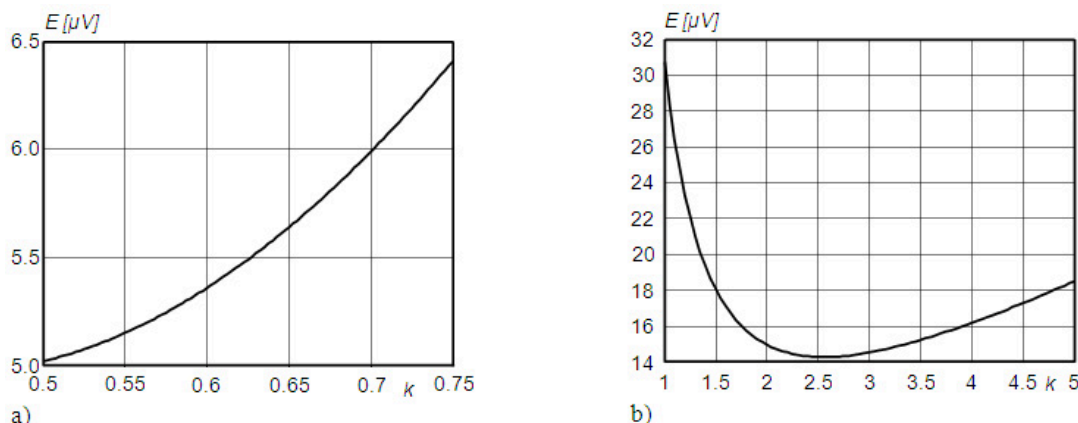

Fig. 3. RMS noise voltage as function of k ; a) LP, b) BP filter

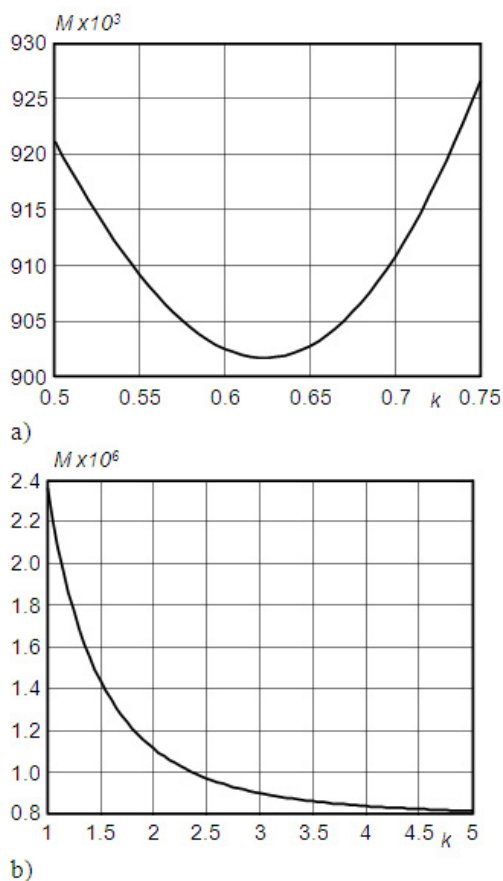

Fig. 4. Multi-parameter sensitivity measure as function of k ; a) LP, b) BP filter

tivity optimization of BP filter gives factor $k = 4.25$. For the k higher than this one, constraint regarding R_3 is not fulfilled.

The values of the filters elements are presented in Ta-

ble 1. The first column shows values from simple design (SD), the second column gives values from optimization over noise (NO), the third column from optimization over sensitivity (SO) and the fourth column from both optimizations (NSO). Numerical indicators E and M are calculated over frequency range 400 Hz – 40 kHz.

Table 1. Elements of simply designed (SD), noise optimized (NO), sensitivity optimized (SO) and noise-sensitivity optimized (NSO) of the 2nd order LP and BP filters

	SD	NO	SO	NSO
LP				
k	1	0.66	0.66	0.66
C_1 [nF]	10	15.1515	15.1515	15.1515
C_2 [nF]	10	6.6	6.6	6.6
R_{11} [kΩ]	7.2902	4.3444	4.3444	4.3444
R_{12} [kΩ]	10.3422	190.4191	190.4191	190.4191
R_2 [kΩ]	4.2472	4.2473	4.2473	4.2473
R_3 [kΩ]	5.7099	358.2152	358.2152	358.2152
R_4 [kΩ]	3.9789	3.9789	3.9789	3.9789
E [μV]	9.5282	5.7073	5.7073	5.7073
M [x10 ⁶]	1.0986	0.9037	0.9037	0.9037
BP				
k	1	2.55	4.25	3.20
C_1 [nF]	10	10	10	10
C_2 [nF]	10	10	10	10
R_{11} [kΩ]	43.7676	19.2504	16.7416	17.7812
R_{12} [kΩ]	4.3766	1.6979	0.9917	1.3369
R_2 [kΩ]	3.9789	10.1461	16.9103	12.7321
R_3 [kΩ]	6.9630	0.8337	0.2065	0.4663
R_4 [kΩ]	3.9789	3.9789	3.9789	3.9789
E [μV]	30.7409	14.2929	16.7296	14.7860
M [x10 ⁶]	2.3605	0.9622	0.8309	0.8825

Figures 5 and 6 show noise voltage spectral density and Schoeffler sensitivity for SD and optimized filters. As it can be seen, the noise and sensitivity are decreased for the whole frequency range for both filters. The noise is approximately as half as without optimization. Significant improvement of sensitivity is obtained in the filter's passbands, for the low frequencies in LP case and around central frequency for BP filter.

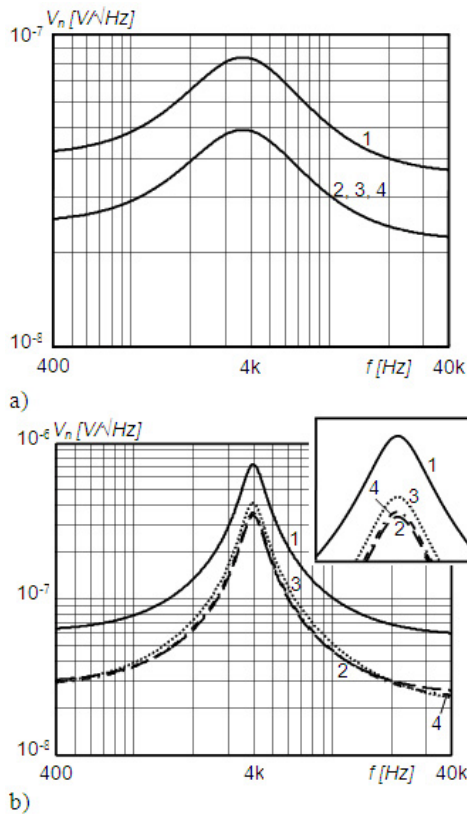

Fig. 5. Noise voltage spectral density for: 1. SD, 2. NO, 3. SO and 4. NSO of the 2nd order; a) LP, b) BP filter

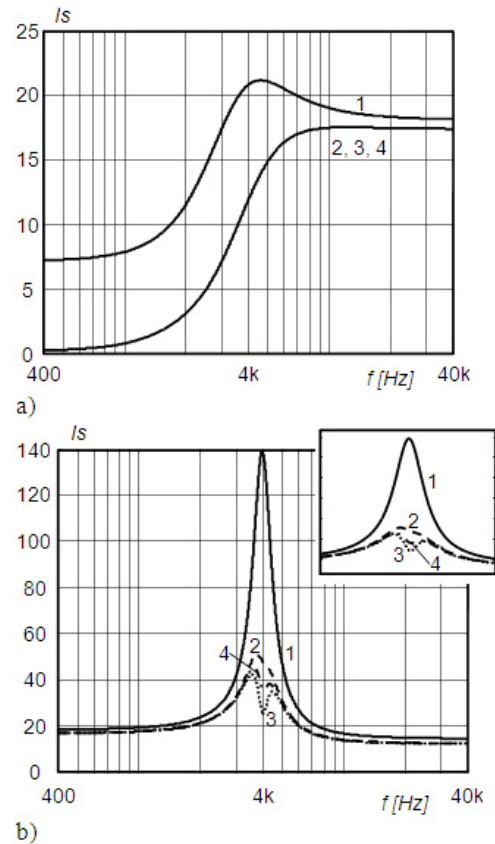

Fig. 6. Schoeffler sensitivity for: 1. SD, 2. NO, 3. SO and 4. NSO of the 2nd order; a) LP, b) BP filter

Let it be mentioned that the optimization of BP filter is also tested using (14) but obtained results did not give any significant reduction of noise or sensitivity.

3 THE FOURTH-ORDER LP AND BP CASCADE FILTERS

The fourth order cascade LP and BP filters realized with two second order sections are shown in Fig. 7.

3.1 Optimization Procedure

In case of the fourth order filters, calculating of elements can be done setting

$$\begin{aligned} C_{1A} &= C_{2A}, R_{1A} = R_{2A} \\ C_{1B} &= C_{2B}, R_{1B} = R_{2B} \end{aligned} \quad (16)$$

From given filter parameters (poles frequency, poles Q-factor and gains) all elements can be calculated analog to the calculations for the second order sections. Optimization is done in two different ways. The first way is to find k which is the same for both second order sections.

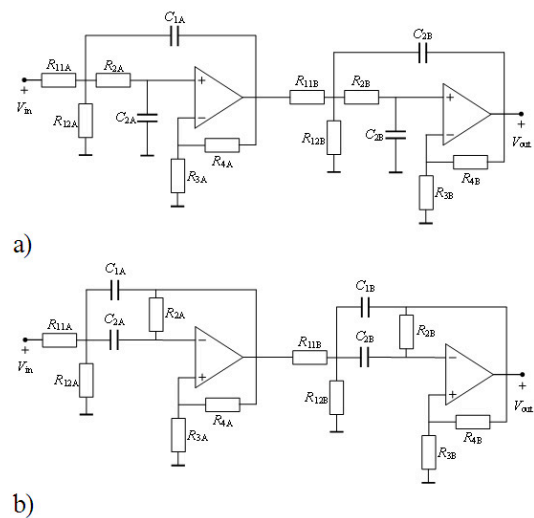

Fig. 7. The 4th order; a) LP, b) BP filter

$$\text{LP : } \begin{aligned} C_{2A} &= k \cdot C_{1A}, R_{1A} = R_{2A} \\ C_{2B} &= k \cdot C_{1B}, R_{1B} = R_{2B} \end{aligned} \quad (17)$$

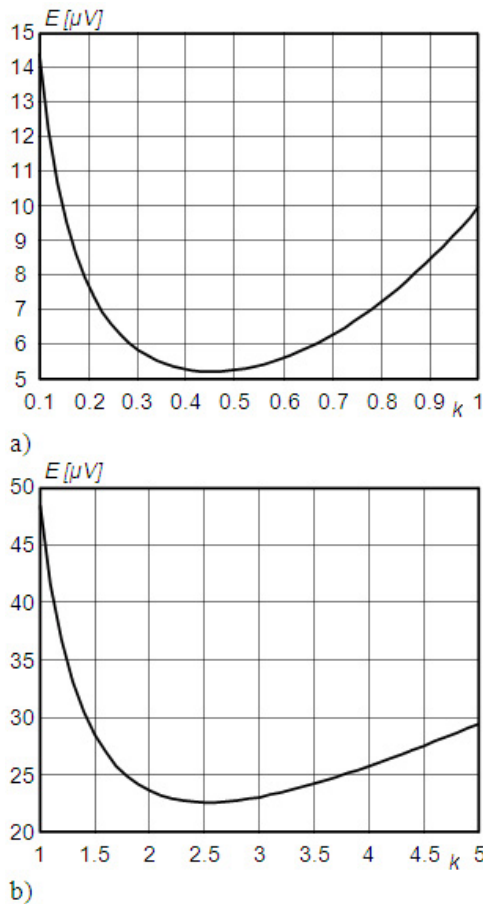

Fig. 8. RMS voltage as function of k ; a) LP, b) BP filter

$$\text{BP : } \begin{matrix} R_{2A} = k \cdot R_{1A}, & C_{1A} = C_{2A} \\ R_{2B} = k \cdot R_{1B}, & C_{1B} = C_{2B} \end{matrix} \quad (18)$$

The other way is to find k_1 for the first 2^{nd} order section and k_2 for the second 2^{nd} order section in cascade.

$$\text{LP : } \begin{matrix} C_{2A} = k_1 \cdot C_{1A}, & R_{1A} = R_{2A} \\ C_{2B} = k_2 \cdot C_{1B}, & R_{1B} = R_{2B} \end{matrix} \quad (19)$$

$$\text{BP : } \begin{matrix} R_{2A} = k_1 \cdot R_{1A}, & C_{1A} = C_{2A} \\ R_{2B} = k_2 \cdot R_{1B}, & C_{1B} = C_{2B} \end{matrix} \quad (20)$$

Both optimizations are performed and better results are obtained using second method ($k_1 \neq k_2$) for the LP filter. In case of the BP filter, obtained results are identical no matter the values of k -s are the same or different. Optimization results are presented for the same and different k 's approach.

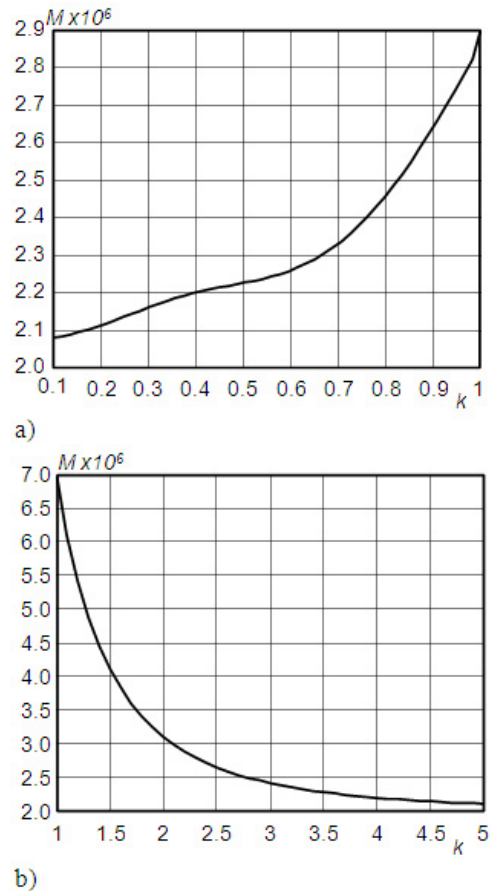

Fig. 9. Multi-parameter sensitivity measure as function of k ; a) LP, b) BP filter

3.2 Example

For example, a fourth-order LP and BP Chebyshev filters with 4 kHz cut-off frequency for LP and 4 kHz central frequency for BP filter are realized. Numerical method for calculating the best k_1 and k_2 in (19) and (20) which gives minimal noise and/or sensitivity is again an iterative procedure. The parameters E and M are calculated using (4) and (10). Obtained results are presented in Fig. 8-11.

From Fig. 8 it is obvious that the noise will be lower for minimums of the presented functions. Minimum of the noise function gives k for which the LP filter's elements do not satisfy set constrains. More details are not presented here because better results are obtained for the different k approach. The value of k chosen in order to obtain minimum function in Fig. 9a gives negative elements and therefore it is not used.

On the other side, from Fig. 9b it is clear that the M function will have lower value for higher k factor. But for higher k factor resistor R_3 goes to zero. That leads to usage of different k -s, presented in Table 2. Figures 10 and

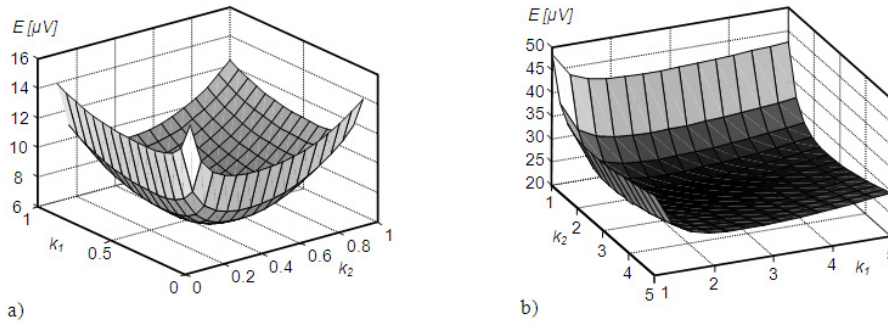

Fig. 10. RMS voltage as function of k_1 and k_2 ; a) LP, b) BP filter

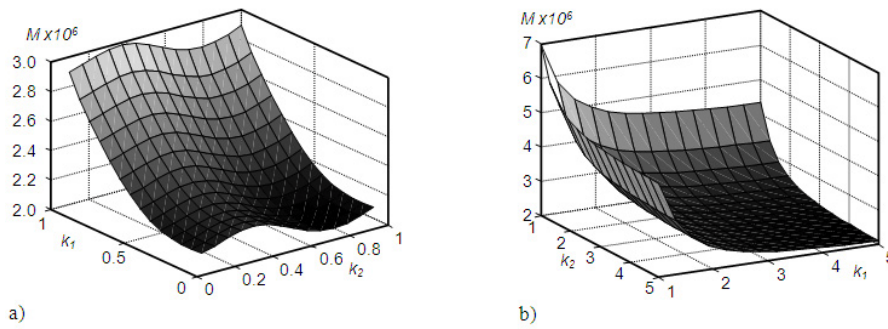

Fig. 11. Multi-parameter sensitivity measure as function of k_1 and k_2 ; a) LP, b) BP filter

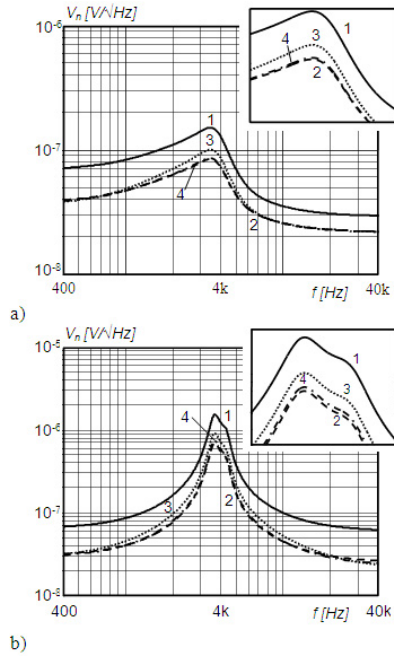

Fig. 12. Noise voltage spectral density for: 1. SD, 2. NO, 3. SO and 4. NSO of the 4th order; a) LP, b) BP filter

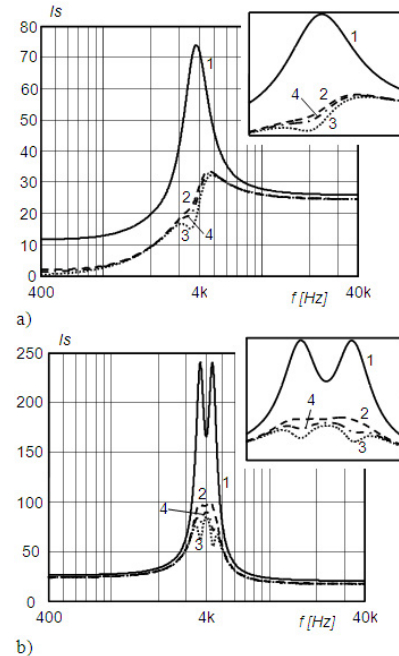

Fig. 13. Schoeffler sensitivity for: 1. SD, 2. NO, 3. SO and 4. NSO of the 4th order; a) LP, b) BP filter

Table 2. Elements of simply designed (SD), noise optimized (NO), sensitivity optimized (SO) and noise-sensitivity optimized (NSO) of the 4th order LP and BP filter

	LP				BP			
	SD	NO	SO	NSO	SD	NO	SO	NSO
k_1	1	0.4150	0.2469	0.3571	1	2.55	4.95	3.35
C_{1A} [nF]	10	24.0964	40.4599	28	10	10	10	10
C_{2A} [nF]	10	4.1500	2.4694	3.5714	10	10	10	10
R_{11A} [k Ω]	10.638	4.8871	4.2711	4.6211	53.1915	21.3238	17.9569	19.3567
R_{12A} [k Ω]	6.8991	29.1411	208.1773	44.3762	3.9075	1.5299	0.7667	1.1512
R_{2A} [k Ω]	4.1852	4.1852	4.1852	4.1852	3.6401	9.2824	18.0187	12.1945
R_{3A} [k Ω]	2.5801	25.7802	450.3583	43.4874	7.3529	0.9866	0.2025	0.5285
R_{4A} [k Ω]	3.9789	3.9789	3.9789	3.9789	3.9789	3.9789	3.9789	3.9789
k_2	1	0.8200	0.8163	0.8163	1	2.55	4.95	3.35
C_{1B} [nF]	10	12.1951	12.250	12.250	10	10	10	10
C_{2B} [nF]	10	8.1999	8.1632	8.1632	10	10	10	10
R_{11B} [k Ω]	8.5623	6.2355	6.1983	6.1983	44.5208	21.3238	17.9569	19.3567
R_{12B} [k Ω]	22.043	317.2230	456.7306	456.7306	4.81995	1.8538	0.9238	1.3915
R_{2B} [k Ω]	6.1153	6.1153	6.1153	6.1153	4.3491	11.0902	21.5280	14.5695
R_{3B} [k Ω]	10.362	202.4191	293.1884	293.1884	7.35294	0.9866	0.2025	0.5285
R_{4B} [k Ω]	3.9789	3.9789	3.9789	3.9789	3.9789	3.9789	3.9789	3.9789
E [μ V]	9.9194	6.3137	6.7839	6.3424	50.1687	22.6385	29.2859	23.8407
M [$\times 10^6$]	2.8949	2.0507	2.0029	2.0254	6.9612	2.6211	2.1139	2.3165

11 show indicators E and M as functions of different k -s. RMS voltage noise and multi-parameter sensitivity measure are better in darker area.

Elements' values for the 4th order filter realized as cascade of two 2nd order sections are presented in Table 2. The first column shows values from simple design, the second column gives values from optimization over noise, the third column from optimization over sensitivity and the fourth column from both optimizations. Numerical indicators E and M are calculated over frequency range 400 Hz – 40 kHz.

Figures 12 and 13 give noise voltage spectral density and Schoeffler sensitivity for SD and optimized filter over observed frequency range. As it can be seen, the figures for noise, sensitivity and both optimizations are very close to each other in whole frequency range. That means that if noise optimization is used even the Schoeffler sensitivity will be much lower and vice versa. It is clear that noise voltage spectral density is reduced for the whole frequency range with regard to simple design. Significant reduction of sensitivity is obtained close to cut-off frequency for LP and central frequency for BP filter.

4 SPICE SIMULATION

As a confirmation of the previous results, the filters are tested with TopSPICE programming tool. Obtained

characteristics are presented in Figures 14-17. Excellent matching with previous results obtained from Matlab calculations can be seen.

5 CONCLUSION

In this paper, optimizations of second and forth-order filters over noise and sensitivity are analyzed. As optimization result, reduced noise and sensitivity figures are obtained, no matter the filter order. Also, reducing of observed parameters is obtained for the both filter types, LP and BP filter. It is significant that optimizing the noise will also give reduced sensitivity and vice versa. Obtained results show improvements from two to ten times. Also, it is important that higher improvements are obtained in pass bands for both filter types.

The fourth order filter can be optimized in two ways, with equal or different k -s. The obtained results give lower noise and sensitivity if different k -s are used in LP mode. For the BP filter results are practically the same.

Typical commercial operational amplifier is used in calculations. The voltage source's noise is 20 nV/sqrt(Hz). For even better results, a low noise amplifier can be used, for example with 2 nV/sqrt(Hz), which is also commercially available.

The further development in optimization on noise and sensitivity can be done for cascade of biquart filter structure where feedback is added.

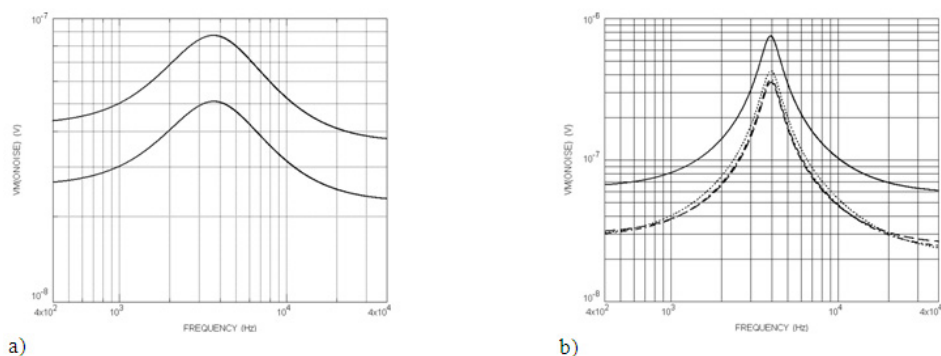

Fig. 14. Noise voltage spectral density using Spice of the 2nd order; a) LP, b) BP filter

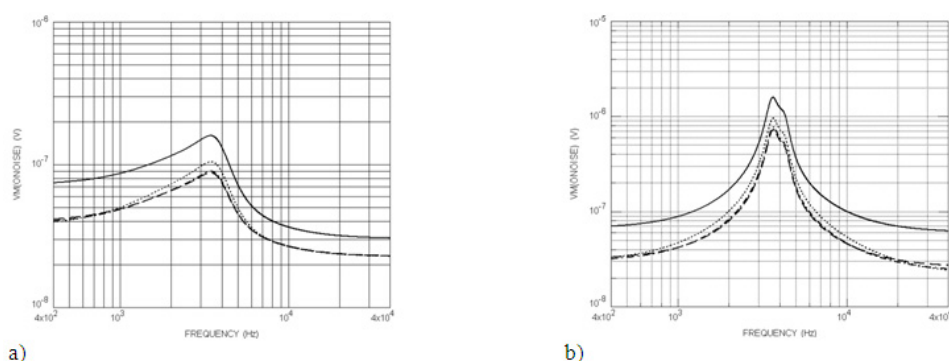

Fig. 15. Noise voltage spectral density using Spice of the 4th order; a) LP, b) BP filter

REFERENCES

- [1] G. S. Moschytz, "Low-Sensitivity, Low-Power, Active-RC Allpole Filters Using Impedance Tapering," *IEEE Trans. On Circuits and Systems*, vol. CAS-46(8), pp. 1009-1026, Aug. 1999.
- [2] D. Jurišić, G. S. Moschytz and N. Mijat, "Low-Sensitivity SAB Band-Pass Active-RC Filter Using Impedance Tapering", in Proc. of ISCAS 2001, (Sydney, Australia), Vol. 1, pp. 160-163, May 6-9, 2001.
- [3] D. Jurišić, G. S. Moschytz and N. Mijat, "Low-Sensitivity Active-RC High- and Band-Pass Second-Order Sallen and Key Allpole Filters," In Proc. of ISCAS 2002, (Phoenix, Arizona-USA), Vol. 4, pp. 241-244, May 26-29, 2002.
- [4] D. Jurišić, N. Mijat and G. S. Moschytz, "Optimal Design of Low-Sensitivity, Low-Power 2nd-Order BP Filters," in Proc. of ICSES 2008, (Krakow, Poland), pp. 375-378, September 14-17, 2008.
- [5] D. Jurišić, G. S. Moschytz and N. Mijat, "Low-Noise, Low-Sensitivity, Active-RC Allpole Filters Using Impedance Tapering," *International Journal of Circuit Theory and Applications*, n/a. doi: 10.1002/cta.740.
- [6] D. Jurišić, G. S. Moschytz and N. Mijat, "Low-Sensitivity Active-RC Allpole Filters Using Optimized Biquads," *Automatika*, vol. 51, no. 1, pp. 55-70, Mar. 2010.
- [7] Stojković N., Mijat N., "Noise and Dynamic Range of Second Order OTA-C BP Filter Sections", *Proceedings of ECCTD'99 Int. Conf.*, 1999., Stresa, Italy, pp. 795-798
- [8] Zurada J., Bialko M., "Noise and Dynamic Range of Active Filters with Operational Amplifiers", *IEEE Transactions on Circuits and Systems*, October 1975, pp. 805-809
- [9] N. Stojković, D. Jurišić, N. Mijat, GIC based Third-order Active Low-pass Filters, *Proc. 2nd IEEE R8 EURASIP Symposium on Image and Signal Processing and Analysis*, Pula, Croatia, 2001, pp. 486-490.
- [10] J. D. Schoeffler, The Synthesis of Minimum Sensitivity Networks, *IEEE Transactions on Circuit Theory*, pp. 271-276, June 1964.

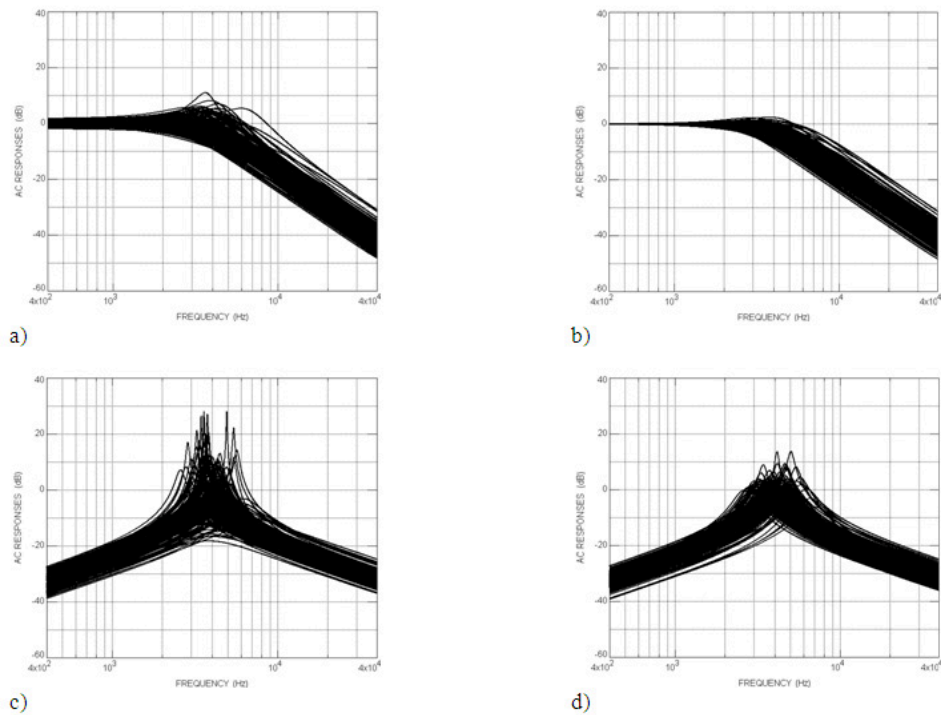

Fig. 16. Monte Carlo response plots of the 2nd order; a) LP simple design, b) LP sensitivity optimized, c) BP simple design, d) BP sensitivity optimized

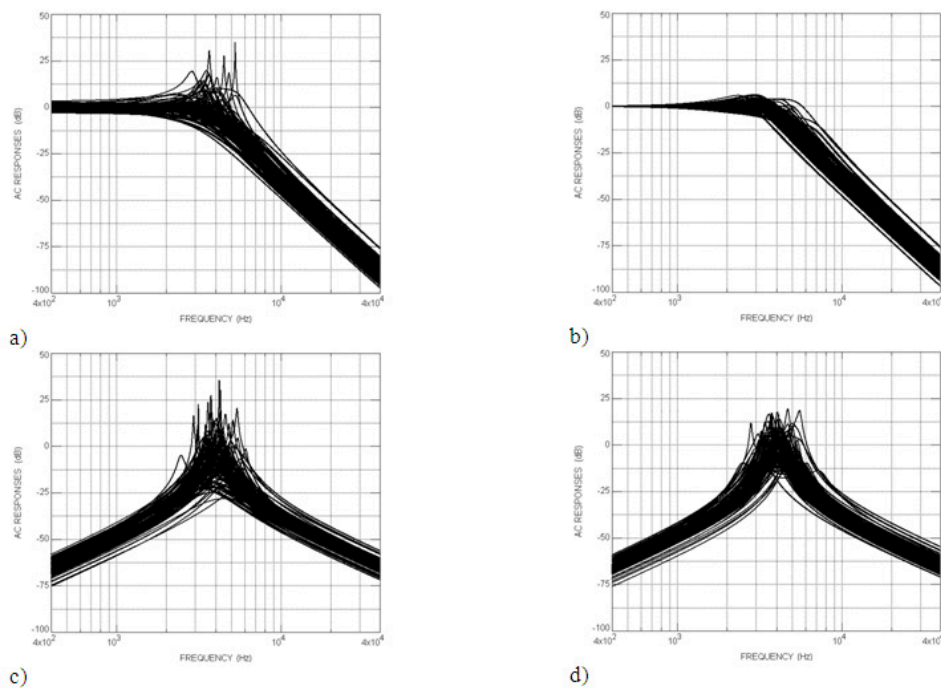

Fig. 17. Monte Carlo response plots of the 4th order; a) LP simple design, b) LP sensitivity optimized, c) BP simple design, d) BP sensitivity optimized



Nino Stojković received a B.Sc. degree in 1989., an M.Sc. degree in 1995 and a Ph.D. degree in 1999, all from the Faculty of Electrical Engineering and Computing, University of Zagreb. In 2005 he earned the title of associate professor at the Faculty of Engineering, University of Rijeka. He was a researcher on fourth scientific projects supported by the Croatian Ministry of Science, Education and Sports and led one scientific project. His research interests include analog signal processing and communication technologies.

He was a Fulbright grantee for the year 2003/2004 at Texas A&M University, College Station, Texas. He was Vice Dean for education and Chair of the Department of Automation, Electronics and Computing.



Ervin Kamenar received a Bachelor degree in 2008 and Master degree in 2010 in electrical engineering, both from the Faculty of Engineering, University of Rijeka. His research interests include analog signal processing.



Mladen Šverko received a Bachelor degree in 2008 and Master degree in 2010, both from the Faculty of Engineering, University of Rijeka. His research interests include analog signal processing and renewable energy systems.

AUTHORS' ADDRESSES

Prof. Nino Stojković, PhD.

Ervin Kamenar, B.Sc.

Mladen Šverko, B.Sc.

Faculty of Engineering

University of Rijeka

Vukovarska 58, 51000 Rijeka

HR - Croatia

e-mail: nino.stojkovic@riteh.hr,

ervin.kamenar@gmail.com, msverko@hotmail.com

Received: 2010-09-03

Accepted: 2011-01-28