

MODELLING AND OPERATIONAL TESTING OF PULSE-WIDTH MODULATION AT INJECTION TIME FOR A SPARK-IGNITION ENGINE

Ioan Hiticas, Daniel Marin, Liviu Mihon

Original scientific paper

Nowadays, the computer control has to be taken into account in any field of study. Due to the advantage of its binary system, it can very quickly control the signals from devices. This paper is focused on the analysis of some studies carried out on the PWM (Pulse Width Modulation) technologies. The engines used nowadays are provided with an electronic injection system. During our research, we have made a connection between a few parameters which contribute to the increase of the engine performance. Our team has used the PWM, a common technique employed for controlling power to inertial electrical devices, in order to show the benefits of the injection time control; the results regarding the engine management have been very good. We have taken into account a few parameters such as pressure, battery voltage, lambda signals, fuel and air amount, etc., as well as their time evolution, with the help of the ECU control. Using the MATLAB/Simulink software, we have managed to control, by using the pulse width modulation, the reference speed, the throttle position, as well as other parameters and data collected from the tests carried out on Dacia Logan 1.4 MPI (powered by Renault), and the evolution of the injection time. By creating a PWM signal, we can precisely control the injection time.

Keywords: *current measurement, digital signal processing, oscilloscopes, pulse width modulation, voltage control*

Modeliranje i operativno testiranje modulacije širine impulsa kod vremena ubrizgavanja za motor paljen pomoću svjećice

Izvorni znanstveni članak

Danas, kada govorimo o bilo kojem polju moramo uključiti upravljanje računalom. Zbog prednosti njegovog binarnog sustava, ono može upravljati signalima iz uređaja i kontrolirati ih u vrlo kratkom vremenu. U ovom radu smo željeli predstaviti studije i istraživanja tehnologije PWM (Pulse Width Modulation - modulacije širine impulsa). Današnji motori su opskrbljeni s elektronički upravljanim sustavom ubrizgavanja. Tijekom istraživanja uspostavili smo vezu između nekoliko parametara koji su uključeni u povećanje performansi motora. PWM, najčešće korištena tehnika za kontroliranje snage inercijskih električnih uređaja, korištena je za predstavljanje prednosti kontrole vremena ubrizgavanja, s vrlo dobrim rezultatima u sustavu upravljanja motorom. Uzeli smo u obzir neke parametre, kao tlak, napon baterije, lambda signale, količinu goriva i zraka, itd., a sve to u vremenskom razvoju s ECU pomoćnim upravljanjem. Korištenje MATLAB/Simulink softvera uspjeli smo upravljati, počevši od referentnih brzina, položaja regulacije i drugih parametara, potrebnih podataka iz ispitivanog vozila, Dacia Logan 1.4 MPI (pokretanog Renaultom), razvojem vremena ubrizgavanja uporabom modulacije širine impulsa. Stvaranjem PWM signala možemo točno kontrolirati vrijeme ubrizgavanja.

Ključne riječi: *digitalna obrada signala, modulacija širine impulsa, osciloskopi, regulacija napona, trenutačno mjerenje*

1 Introduction

The internal combustion engines have always represented a very good topic of discussion in the field of the propulsion systems. The processes in the combustion chamber engage different elements involved in chemical reactions between air and fuel. The thermal engine opens a new direction of research in science and, consequently, it raises new questions that have to be answered.

The invention of the injector was inspired by a woman using a perfume spray bottle; this woman was the wife of Rudolf Diesel, the inventor of the diesel engine, who had a moment of enlightenment when he saw his wife perfuming herself. This raised the idea to use a nozzle in order to spread the fuel inside the combustion chamber. Nowadays, the road vehicles are very complex due to many sensors, actuators, control units, systems prepared to meet drivers' needs.

The MATLAB/Simulink software used by our team helps us to optimize a few parameters involved in raising the engine performance. Both the injector and the injection time must be very well analysed and calculated.

The oxygen sensor is able to monitor the amount of oxygen in exhaust gases. Thus, the upstream and the downstream oxygen sensors can control the fuel consumption and the level of exhaust via the ECU (Engine/Electronic Control Unit).

The engine speed is also a very important parameter for our study and experimental research. Due to the

throttle position, the engine speed either increases or decreases. The battery voltage has also been monitored.

The injectors and the fuel quantity must be precisely pre-calculated for both engines, namely the compression engine and the spark ignition engine.

The main purpose of the paper is to present the benefits of the pulse width modulation, an application belonging to the electric field. We have analysed how the PWM works [1, 2], its benefits for the automotive area, and we have described the way in which we can implement our ideas.

2 Technical data

The route of the fuel is already well-known, but the connection between the engine power and the PWM must be dealt with and explained in detail. The basic application of PWM [3, 4] to the machine motor, to the AC electric motor, etc., is widely-known. One early application of PWM was made in the 1960s to an audio amplifier; the evolution of this technology led to innovative studies carried out in new areas of development.

What is a PWM? How does the PWM contribute to the increase of the thermal engine performance? Do we really need this application, belonging to a different area, in our spark ignition engine, where we have to do with fuel, lambda, etc.? The PWM is a "technology" which allows us to control, with high precision, the increase of the engine performance, in which many parameters are

involved. The PWM is a signal produced at a precise moment and for an exact period of time. Nowadays, all the vehicles are provided with many sensors useful for the engine management. The "head" of all these parameters controlled by sensors is the ECU of the engine, but also other ECUs.

The PWM was applied for the first time to the AC motor drive. The PWM application is specific to the high power equipment from power DC systems, such as inverters. The technological evolution leads to the development of the piezoelectric injectors used in the diesel engines. The major advantages of the piezoelectric injector are the extremely high-speed and the injection of an exact amount of fuel. Its efficiency is based on the PWM application; it functions like a solenoid valve, opening and closing very quickly, according to the driver/engine requirements.

The vehicles must guarantee the safety and the security of both the drivers and the pedestrians, irrespective of the regimes to which the vehicles are subjected during their lifetime. The PWM application can contribute to giving a high response very rapidly, upon the driver's request, such as maximum speed in a very short period of time.

The usual operation of an engine implies the normal functioning of the parameters which can be controlled by means of sensors. Some of these parameters are: the reference speed of the engine, the oxygen sensor signals (upstream and downstream), the injection time, the pressure, and the crankshaft position sensor. All these parameters can be monitored through OBD, with the aid of dedicated software.

The block scheme of the PWM (Fig. 1) presents the route of the pulse, starting from the engine ECU and passing through the injection ECU, where the pulse is generated with the help of sensors and of the driver's command. The most important sensor for generating the PWM is the crankshaft position sensor, which functions on the basis of the Hall Effect.

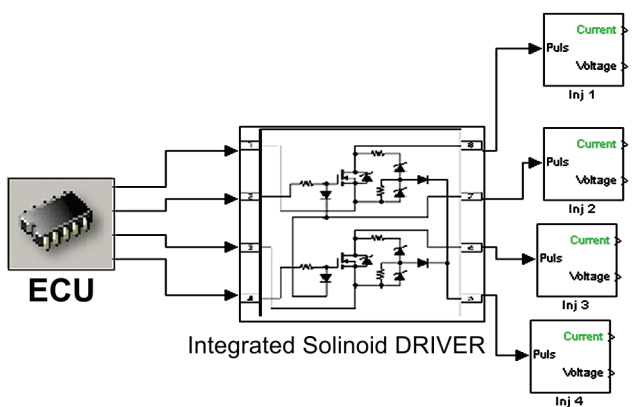

Figure 1 ECU injector PWM

3 Experimental research

The measurements have been made on a Dacia Logan 1.4 MPI, vehicle, manufacture year 2006, technical specifications: displacement 1390 cm³, 4 cylinders in line, power 54,4 kW (73 HP) at 5500 rpm, torque 112 N·m at 3000 rpm, 100 km/h speed in 13 s, CO₂ emission 164 g/km. The data have been stored with the aid of dedicated

software, namely DDT2000, for Renault-Dacia-Nissan [5].

Nowadays, due to the development of the direct injection, we are not concerned about the carburettor system anymore. The specialists in this field have developed the multi-point injection, namely a system in which the gasoline is injected into each intake port. This system is used, to a large extent, at the engine and vehicle construction. The direct injection is meant to allow a greater control of the injection quality [6, 7]; this control concerns the fuel amount and the injection time. The vehicle tested by our team is provided with a MPI system.

The increase of the engine performance depends on many parameters. The ECU of the engine must be able to control all the parameters which influence the vehicle/engine behaviour [8, 9]. Our purpose is to monitor the injection time [10, 11] and to present the advantage of the PWM.

One of the most important aspects to be considered is the amount of fuel, namely m_f (kg). [12] The output power of the engine varies between P_{min} and P_{max} .

$$\frac{P_{max}}{P_{min}} = 100. \tag{1}$$

The relation between the amount of fuel and power is represented by the following equation:

$$\dot{m}_f = \frac{P_e}{\eta_e \cdot e_f}, \text{ kg/s} \tag{2}$$

where:

P_e – effective power, W

η_e – effective thermodynamic efficiency, –

e_f – specific energy of the fuel released during combustion, J/kg.

As we may know, a certain amount of fuel [13, 14] is injected during each cycle of the engine. These amounts of fuel are injected in a few milliseconds, which are directly proportional to the engine speed, n , and directly related both to the cycles of the engine and to the cylinder of the engine; based on these, the following equation arises:

$$m_f = \int_0^{n \cdot CYL} \dot{m}_f dt, \text{ kg} \tag{3}$$

where:

\dot{m}_f – constant fuel flow during stationary operation, kg/s

CYL – number of cylinders of the engine.

The equation above (3) leads to the following relation, which helps us to calculate the fuel amount:

$$m_f = \frac{\dot{m}_f}{n} \cdot \frac{2}{CYL}, \text{ kg}. \tag{4}$$

The variation of the fuel amount, between the

maximum and the minimum level leads to the following ratio:

$$\frac{m_{\max}}{m_{\min}} = \frac{P_{\max}}{P_{\min}} \cdot \frac{n_{\min}}{n_{\max}} = 10. \quad (5)$$

In order to calculate the injection time, t_{inj} , we take into consideration a constant air flow mass $\dot{m}_a = \text{const.}$ (kg/s). Because the injected fuel amount is proportional to the injection time, the equation for calculating the fuel amount, until the valve of the injector is open, is the following:

$$m_f = \frac{m_a}{L_{\text{st}} \cdot \lambda} \cdot \frac{1}{n} \cdot \frac{2}{\text{CYL}}, \text{ kg.} \quad (6)$$

Moreover, another important element for the engine behaviour is the amount of air, m_a (kg).

The pistons of the engine compress a volume of air-fuel mixture, V_d , under a normal pressure (atmospheric pressure) of $p_0=1,013$ bar, with an air density of $\rho_0=1,29$ kg/m³, represented by the expression $m_{a,\text{th}}=p_0 \cdot \rho_0 \cdot V_d$. As regards the air mass, the relation between the real and the theoretical values leads to the following relation:

$$\lambda_a = \frac{m_a}{m_{a,\text{th}}}. \quad (7)$$

Where:

m_a – real air mass, kg

$m_{a,\text{th}}$ – theoretical air mass, kg.

Following the same judgment, the following relation arises for the fuel mass:

$$\lambda_f = \frac{m_f}{m_{f,\text{th}}}. \quad (8)$$

Another important element involved in the engine combustion process, as well as in the increase of the engine performance, is the air/fuel ratio, λ , which significantly influences the calculation of the injection time [15, 16].

The relation between lambda, air amount and fuel amount, is represented by the following equation:

$$\lambda = \frac{m_a}{m_f} \cdot \frac{m_{f,\text{th}}}{m_{a,\text{th}}} = \frac{1}{L_{\text{st}}} \cdot \frac{m_a}{m_f}. \quad (9)$$

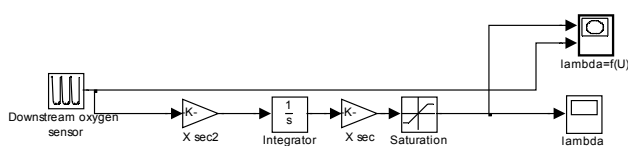

Figure 2 MATLAB lambda model

Based on the data collected during our experimental research, we present the evolution of the lambda parameter, in accordance with the fuel and the air amount; the graphic (Fig. 3) was obtained by using the MATLAB/

Simulink [17, 18] model (Fig. 2).

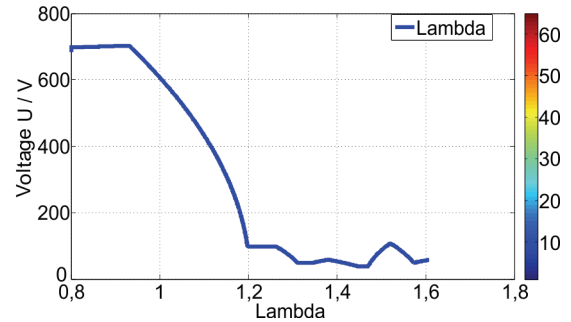

Figure 3 Measured lambda evolution $f(U)$

In normal condition [19, 20], if gasoline is used as fuel, the stoichiometric ratio, L_{st} , is defined by the following relation:

$$L_{\text{st}} = \frac{m_{a,\text{th}}}{m_{f,\text{th}}} = 14,66. \quad (10)$$

We also know that m_f is proportional to the square root of the pressure difference Δp between the fuel rail and the intake manifold pressure. In order to simplify the injection time calculation, we consider that the fuel density and the effective opening area of the valve are constant. As regards the intake manifold, the pressure difference is around 5 bar, while, as regards the direct injection, the pressure difference reaches 400 bar. This difference of pressure must be taken into consideration [21, 22].

We can calculate the injection time, taking into account the elements mentioned above, with the aid of the following equation:

$$t_{\text{inj}} \cong \frac{1}{\lambda} \cdot \frac{\dot{m}_a}{n} \cdot \frac{2}{\text{CYL}}. \quad (11)$$

For a reference air-fuel ratio, λ_0 , a reference injection time t_0 is proportional to:

$$t_0 \approx \frac{1}{\lambda_0} \cdot \frac{\dot{m}_a}{n} \cdot \frac{2}{\text{CYL}}, \quad (12)$$

where \dot{m}_a – amount of air (measured), kg/s.

These equations (11 and 12) allow us to determine the injection time.

As the crankshaft sensor position is a very important element, we are going to present some data concerning the Hall Effect. The Hall sensor is meant to perceive the position of the pistons. It is influenced by the voltage difference, the electric current and the magnetic field, as follows: if we have an electrical conductor, transverse to an electrical current, perpendicular to the current direction, then we have a transverse electric field and a potential difference. Based on this phenomenon, the ECU of the internal combustion engine always knows which piston reaches the TDC (Top Death Centre) and when that piston reaches the TDC.

We have developed a type of the Hall Effect, using the MATLAB/Simulink application, in order to discover

the position of the piston (Fig. 4). Based on the data stored by us (by using a dedicated software, namely DDT 2000), we have managed to find out the piston position within our simulation (Fig. 5). The Hall Effect provides a digital logic bit control at each sensor movement.

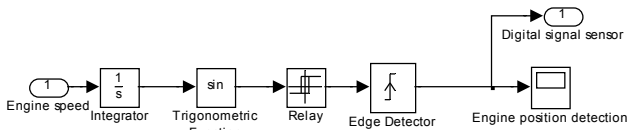

Figure 4 Digital Hall sensor scheme from MATLAB/Simulink

The Hall sensor is an electronic system, without contact, which is strongly related to the moment of ignition ("no contact = no wear").

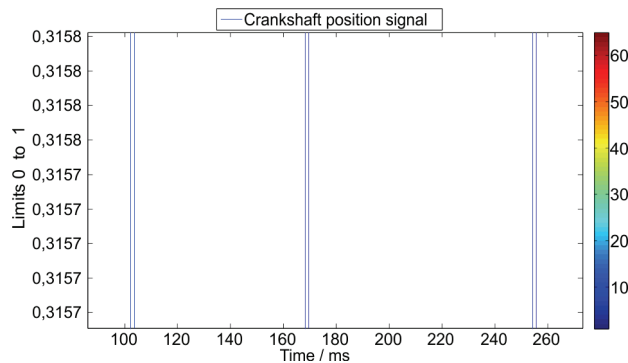

Figure 5 Digital Hall Effect simulation detection

The advantages of this solution are the following:

- It does not show wear.
- It does not require maintenance ("maintenance free").
- It provides uniform ignition signals.
- The flash point remains constant (at the same point of the operation).

Now, since the pistons have been detected, we can present the modulation of the pulse width.

The evolution of the PWM signal during the engine cycle [23, 24], for an engine on direct injection, shows various levels of compression and combustion stroke, for which the PWM signals are very important. During an engine cycle – intake, compression, combustion and exhaust strokes (Fig. 6) – the ECU of the engine controls the injection time, receiving commands from the driver, with the aid of the throttle position sensor [25].

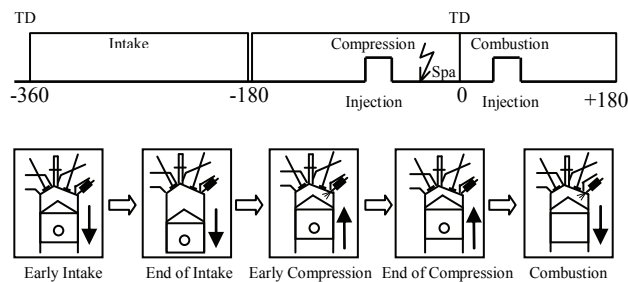

Figure 6 Spark ignition engine cycle on direct injection

The MATLAB/Simulink model has been used by our team in order to analyse the injection time, as well as to optimize the fuel amount. Before both the multi-point and the mono-point injection, the ignition angle has been

mechanically realised; this has an impact both on the precision and on the performance of the engine.

Furthermore, a problem is represented by the different regimes to which the vehicle has been subjected. The ignition angle was realised only for a few regimes and, on the road, the vehicle has been subjected to some other regimes.

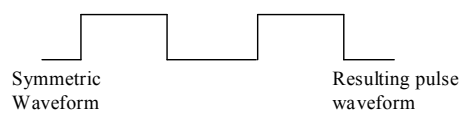
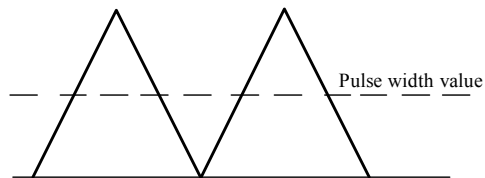
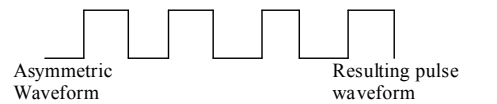
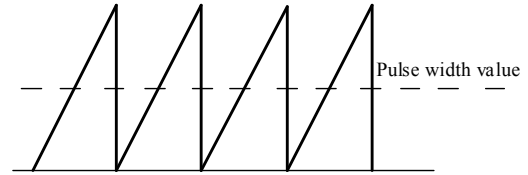

Figure 7 Type of waveform

The great advantage of the PWM is that it works in real time and may be applied to any engine regime [26].

The PWM can present two types of waveforms: asymmetrical and symmetrical. Fig. 7 shows the difference between them.

The symmetrical pulse modulation is presented in the case of the direct injection. The period of the triangular signal is calculated according to the engine speed and represents the time cycle of one cylinder. The triangular signal is compared to a continuous signal, which represents the ratio of time between the injection time, that we want to generate and the cylinder cycle time. By dividing the desired injection time to the cycle time, we obtain a value between 0 and 1; this value corresponds to a maximum injection time which is equal to the cycle time. The usual values are below 0,5 because the injection time period cannot exceed half of a cycle period.

The simulation parameters are the following:

- Engine speed – 1000 rpm
- Cycle time/cylinder – $1/((n/60)/4)$
- PWM sampling frequency – 1000 Hz.

The triangular signal takes values between 0 and 1 in amplitude and the period depends on the engine speed; it represents the engine cycle (Fig. 9). The green line represents the duty cycle, which is a ratio between the injection time and the cycle time. The intersection of these two signals leads to a modulated pulse in time, which can be shorter or longer, depending on the driver's

requests and also on the ECU calculation of the injection time.

The model realised in MATLAB/Simulink, helps us to understand the generation mechanism of the PWM signal (Fig. 8).

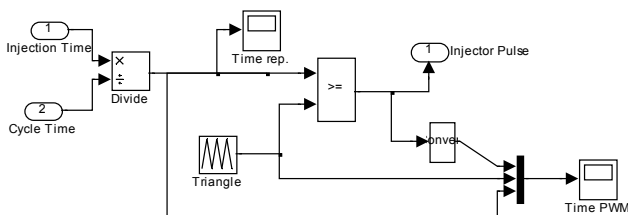

Figure 8 PWM signal generation for injection time

The modulation of the pulse can be performed with the aid of a voltage source. The battery of the engine, together with all its elements, can generate the PWM. Following a MATLAB/Simulink model, we have succeeded in obtaining the tension and the current Fig. 10).

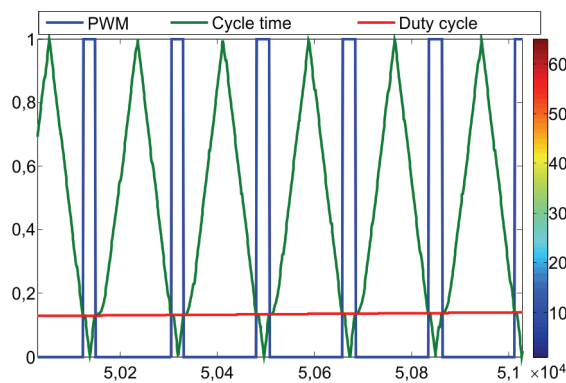

Figure 9 The principle of the PWM signal generation

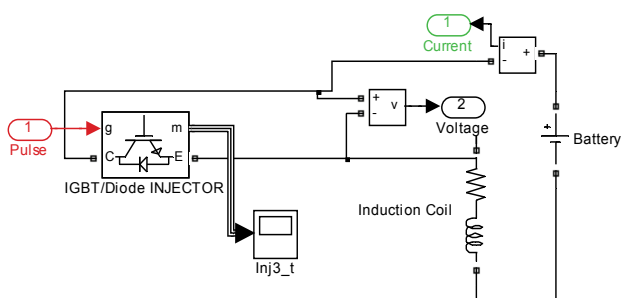

Figure 10 Pulse, current and tension simulation model

The measurements have been made at the "Politehnica" University of Timisoara and are meant to present the benefits of the pulse width modulation for the gasoline injection time, at the spark ignition engine. A digital storage oscilloscope Tektronix 200 MHz has been used. Fig. 11 presents the curve corresponding to the injection time (blue colour – Fig. 11) and the curve corresponding to the current (blue colour – Fig. 11). The pulse width modulation is represented by the green colour. All these three curves have been realised in MATLAB/Simulink and represent the moment of injection, in milliseconds.

This was the theoretical part of the paper. In what follows, we are going to present the measurements made on the tested vehicle, Dacia Logan 1.4 MPI. We have

used an oscilloscope for determining the real injection time of the gasoline inside the combustion chamber [27], [28]. The pulse width modulation marks the moment when the injector valve is going to be opened and the length of time, in milliseconds, that elapses until the gasoline injection is stopped. Fig. 12 shows the length of the injection time, namely 3,4 ms, for the idle speed, while Fig. 13 reveals how the injection time becomes shorter when the speed is increased. The pulse width modulation contributes to a more precise injection time; this leads to a very good engine performance.

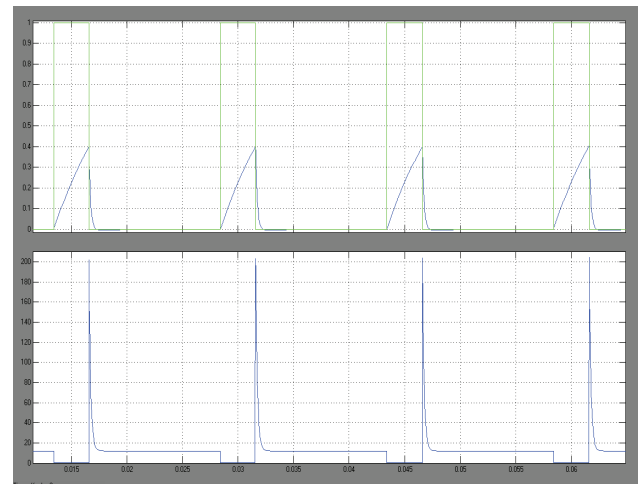

Figure 11 PWM, current and injector tension from MATLAB/Simulink model

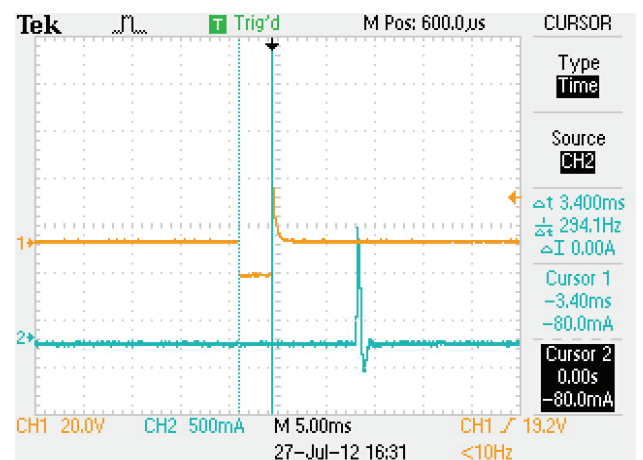

Figure 12 Oscilloscope measurements – injector tension and current spark at idle speed for Dacia Logan 1.4 MPI

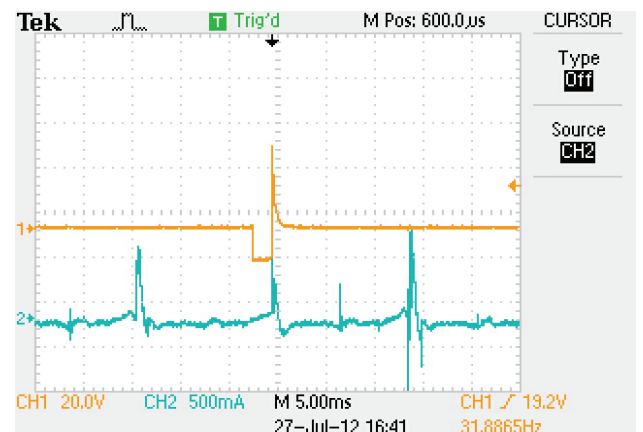

Figure 13 Oscilloscope measurements – injector tension and current spark at 4000 rpm for Dacia Logan 1.4 MPI

The injector signals also imply two elements, namely the current and the tension. The injector block model presents an IGBT/Diode module (Insulated Gate Bipolar Transistor), which is a three-terminal power semiconductor device, with a large area of application, for instance in electric cars or variable speed refrigerators, due to its high efficiency and very fast switching [29]. Our IGBT module for the injector simulation on our tested vehicle has also made the switching between the tension and the current, in real time.

The evolution of the battery voltage has also been monitored (U_b) (Fig. 14). This effect can be offset by a voltage dependence time correction, Δt . As regards our tested vehicle, Dacia Logan, the evolution of the battery voltage is characterised by a very little variation, namely only 10 mV, which does not represent a problem for the PWM.

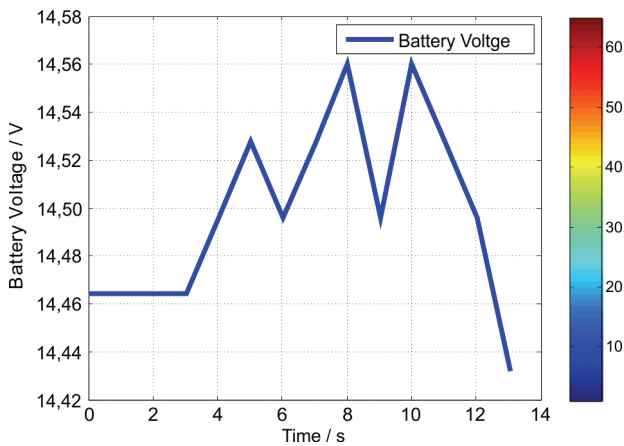

Figure 14 Battery voltage

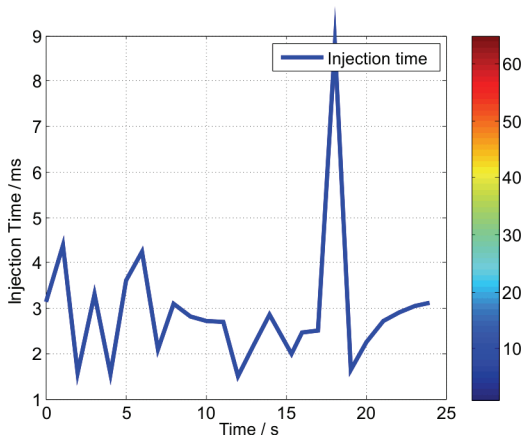

Figure 15 Injection time evolution

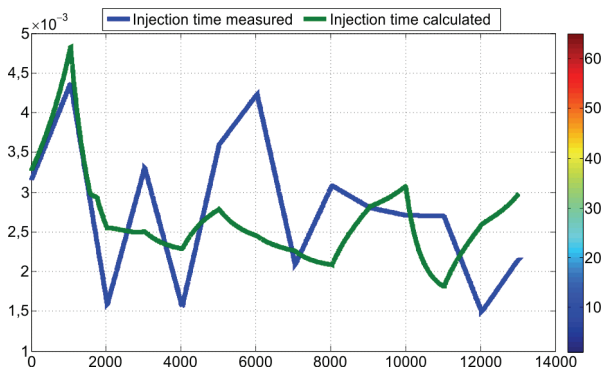

Figure 16 Comparison between injection times

Through our experimental research, we have managed to obtain the evolution of the injection time, measured in real time, with the aid of the modulation of the pulse width (Fig. 15). After the application of the PWM, the engine reaches the maximum speed in the 17th ÷ 18th second.

We also present a comparison between the calculated injection time [30] and the measured injection time. The two curves presented in Fig. 16 are similar; this is the result of our study, being based on the data collected by our team in real time and on the mathematical model realised in MALTAB/Simulink.

4 Conclusion

The engine ECU is able to monitor and control all the parameters of the entire vehicle, including the engine. The different regimes, to which the vehicle is subjected, can create problems to the ECU if it does not work properly.

The PWM application can ensure a very good behaviour of the engine, due to its applicability in this area. As the results of our research may reveal, by calculating the pulse modulation, in accordance with the injection time, as well as with many other parameters, such as pressure, temperature, throttle position, speed, etc., the engine performance is good.

The evolution of the injection time with the aid of the PWM application proved its advantage by offering precision for any engine regime. As the experimental research may reveal, parameters such as fuel amount or air amount, lambda, etc., could be controlled and optimised by means of the MATLAB/Simulink model.

The PWM application helps us to control and to optimise the injection time, having an impact on the engine control.

The lambda values obtained by calculation and our measurements based on our collected data, present very similar curves which allow us to control the lambda parameter.

The connection between lambda, air mass and fuel mass, which is also presented in our experimental research, leads us to the following conclusion: the fuel requirements depend on the lambda values, which are closely related to the throttle position, as well as to the engine speed.

All the parameters of the engine present advantages after the application of the PWM; this means that, in the future, it may be applied to all the vehicles.

Acknowledgment

This work was partially supported by the strategic grant POSDRU/88/1.5/S/50783, Project ID 50783 (2009) co-financed by the European Social Fund – Investing in People, within the sectorial Operational Programme Human Resources Development 2007 ÷ 2013.

This work was partially supported by the strategic grant POSDRU/21/1.5/G/13798, within POSDRU Romania 2007-2013, co-financed by the European Social Fund – Investing in People.

5 References

- [1] Chong, T. S.; Lai, Y. M.; Tse, C. K. Implementation of pulse-width-modulation based sliding mode controller for boost converters. // *Power Electronics Letters*, IEEE database, (2005), pp. 133-135.
- [2] Kukrer, O.; Komurcugil, H. Variable sampling frequency PWM waveforms. // *Power Electronics Letters*, IEEE database, (2003), pp. 14-16.
- [3] Holtz, J. Pulse width modulation for electronic power conversion. // *Proceedings of the IEEE*, (1994), pp. 1194-1214.
- [4] Holtz, J. Pulse width modulation-a survey. // *IEEE Transactions on Industrial Electronics*, 39, 5(1992), pp. 410-420.
- [5] Renault SAS, "DDT2000 functionalities", English version, June 2008.
- [6] Kiencke, U.; Nielsen, L. *Automotive Control System, for engine, Driveline and Vehicle*, Springer, Germany, 2005.
- [7] Merker, G. P.; Schwarz, C.; Teichmann, R. *Combustion Engines Development, Mixture Formation, Combustion, Emissions and Simulation*, Springer, Germany, 2012 (original German edition in 2009).
- [8] Bell, C. *Maximum Boost, Design, Testing and Installing Turbocharger System*, Bentley Publishers, 1997.
- [9] Bosch, R. *Gasoline Fuel-Injection, System K-Jetronic*, Technical Instruction, Germany, 2000.
- [10] Dziubiński, M.; Czarnigowski, J.; Nieoczym, A. Simulation Tests of Injection System Reliability. // *International Journal of Materials & Structural Reliability*, 4, 1(2006), pp. 79-88.
- [11] Sujing, W.; Lide, W.; Ping, S.; Biao, L.; Xiaobo, N. Research on electronically controlled fuel injection system, *Vehicle Power and Propulsion Conference*, IEEE database, (2008), pp. 1-5.
- [12] Wallington, T. J.; Kaiser, E. W.; Farrell, J. T. Automotive fuels and internal combustion engines: a chemical perspective. // *Chemical Society Reviews*, 35, 4(2006), pp. 335-347.
- [13] Hiticas, I.; Marin, D.; Mihon, L.; Resiga, E.; Iorga, D. Parameters Control of a Spark Ignition Engine through Programmable ECU for Specific Regimes, 7th IEEE International Symposium on Applied Computational Intelligence and Informatics, Proceedings, Romania, (2012), pp. 399-404.
- [14] Hiticas, I.; Iorga, D.; Mihon, L.; Resiga, E.; Uricanu, N. Studies and experimental research concerning the performances of the internal combustion engine, controlled over the power train control module. // *Fiability & Durability Journal*, Romania, (2012), pp. 23-28.
- [15] Yiming, H.; Xianyi, Q. Electric-control fuel injection system, *Computer Application and System Modelling*, International Conference on IEEE, Taiyuan, (2010), pp. 625-627.
- [16] Scillieri, J. J.; Buckland, J. H.; Freudenberg, J. S. Reference feed forward in the idle speed control of a direct-injection spark-ignition engine. // *IEEE Transactions on Vehicular Technology*, (2005), pp. 51-61.
- [17] Tianyu, Z.; Haiqiao, W.; Jian, Z. Simulation of the original injection MAP diagram of electronic-controlled gasoline engines based on MATLAB/SIMULINK, *Electrical and Control Engineering*, International Conference on IEEE, Yichang, China, (2011), pp. 815-819.
- [18] Bin Romlie, M. F.; Pesol, M. F.; Hasan, K. N. M. PWM technique to control speed of induction motor using Matlab/xPC target box, *Power and Energy Conference*, IEEE 2nd International, Johor Bahru, Malaysia, (2008), pp. 718-721.
- [19] Haiping, Y.; Xianyi, Q. The calculation of main parameters of the gasoline engine fuel injection system, *Computer Application and System Modelling*, International Conference on IEEE, Taiyuan, China, (2010), pp. 635-637.
- [20] Beckmann, R.; Drewelow, W. Modelling and exact feed forward control of air and burned gas fraction within SI engine cylinders, 16th International Conference on Methods and Models in Automation and Robotics (MMAR), Rostock, August 2011, pp. 316-321.
- [21] Saraswati, S.; Chand, S. An optimization algorithm for neural predictive control of air-fuel ratio in SI engines, *Modelling, Identification and Control (ICMIC)*, (2010), pp. 527-532.
- [22] Rohwein, G. J. An efficient, power-enhanced ignition system, *IEEE Transactions on Plasma Science*, (1997), pp. 306-310.
- [23] Kyu, M. C.; Oh, W. S.; Kim, Y. T.; Kim, H. J. A New Switching Strategy for Pulse Width Modulation (PWM) Power Converters. // *IEEE Transactions on Industrial Electronics*, (2007), pp. 330-337.
- [24] Curto-Risso, P. L.; Medina, A.; Hernandez, A. C. Theoretical and simulated models for an irreversible Otto cycle. // *Journal of Applied Physics*, 104, 9(2008), pp. 1-11.
- [25] Sivakumar, D. B.; Arulmozhi, M.; Senthil, K. T. Performance & emission of Si engine with oxygenated fuel, *Advances in Engineering. / International Conference on Science and Management*, (2012), pp. 117-120.
- [26] Kanellos, F. D.; Tsekouras, G. J.; Prousalidis, J.; Hatzilau, K. I. Effort to formulate voltage modulation constraints in ship-electrical systems with pulsed loads. // *Electrical Systems in Transportation*, 2, 1(2012), pp. 18-28.
- [27] Tayebi, A. Direct time injection in the loop: A new adaptive control point of view. / 28th Chinese Control Conference. // *Proceedings of the 48th IEEE Conference on Decision and Control*, (2009), pp. 3477- 3482.
- [28] Jianwen, L.; Jinhua, L.; Shaohua, S.; Xing, S.; Hong, H. Design of vehicle ECU hardware-in-loop simulation system for electronically controlled engine. / *International Conference on Electrical and Control Engineering (ICECE)*, (2011), pp. 2150-2153.
- [29] Guastavino, G.; Dardano, A.; Torello, E. Measuring partial discharges under pulsed voltage conditions. // *IEEE Transactions on Dielectrics and Electrical Insulation*, 15, 6(2008), pp. 1640-1648.
- [30] Hnatiuc, B.; Pellerin, S.; Hnatiuc, E.; Burlica, R. The study of an electric spark for igniting a fuel mixture. / 12th International Conference on Optimization of Electrical and Electronic Equipment (OPTIM), (2010), pp. 1361-1366.

Authors' addresses

Ioan Hiticas, PhD. Eng.

Politehnica University of Timisoara
Pta. Victoriei, Nr. 2, Timisoara, Romania
E-mail: idhiticas@yahoo.com

Daniel Marin, Assoc. Prof. Dr. Eng.

Hautes Etudes d'Ingénieur
13 rue de Toul F-59046
Lille Cedex, Lille, France
E-mail: dumitru-daniel.marin@hei.fr
E-mail: danielmarin@ieee.org

Liviu Mihon, Conf. Dr. Eng.

Politehnica University of Timisoara
Pta. Victoriei, Nr. 2, Timisoara, Romania
E-mail: liviu.mihon@mec.upt.ro