

## Development of a New Kinetic Model for Methanol to Propylene Process on Mn/H-ZSM-5 Catalyst

N. Hadi,<sup>a,\*</sup> A. Niaei,<sup>a</sup> S. R. Nabavi,<sup>b</sup> A. Farzi,<sup>a</sup> and M. Navaei Shirazi<sup>a</sup>

<sup>a</sup> Department of Chemical Engineering and Applied Chemistry, University of Tabriz, 5166616471, Iran

<sup>b</sup> Department of Applied Chemistry, University of Mazandaran, Babolsar, Iran

Original scientific paper  
Received: September 26, 2012  
Accepted: December 9, 2013

The activity of the H-ZSM-5 was modified by the addition of Ca, Mn, Cr, Fe, Ni, Ag, Ce and P. The highest selectivity of propylene was obtained over the Mn/H-ZSM-5 catalyst. The Mn modified catalyst was selected as the optimal catalyst and the kinetic study was carried out on it. All of the experiments were carried out in an isothermal fixed bed and plug flow reactor with the mixture of methanol and water. The temperature range was 400–550 °C and the weight hourly space velocities (WHSV) of methanol were: 2.51, 5.42, and 8.17 h<sup>-1</sup>. A reaction mechanism based on the theory of hydrocarbon pool and conjugate methylation/cracking mechanisms was proposed. The behavior of the reactor was mathematically modeled and the hybrid genetic algorithm was applied to estimate kinetic parameters. Good agreement was observed between the experimental and the calculated data. Effect of temperature on propylene selectivity was also investigated. It was found that the propylene selectivity steadily increases with temperature.

### Key words:

Kinetic modeling, methanol to propylene process, Mn/H-ZSM-5, hybrid genetic algorithm

## Introduction

The petroleum crisis has obliged societies to find new ways for supplying strategic materials. One of these strategic materials is propylene which is applied widely in modern petrochemical and gas conversion industries. Propylene is an important feedstock for production of many types of polypropylene plastics.<sup>1</sup> Methanol to propylene (MTP) process was launched as a new technology for propylene production. The MTP was generated from methanol to olefins (MTO) process. In both these processes, methanol is used as the feed of the process which is mainly produced from synthesis gas. However, methanol can be easily produced by means of biomass. By development of MTP and MTO processes, the need for crude oil will be eliminated.<sup>2–3</sup> In MTO process, the main objective is to increase the selectivity of ethylene and propylene and it is mostly carried out on silicoaluminophosphate (SAPO) as the catalyst.<sup>4</sup> Because of the small pores of the SAPO molecular sieve structure, it is deactivated fast. In order to overcome this problem, the MTO process is usually carried out in fluidized bed reactors.<sup>5</sup> The MTP process (with higher yield

of propylene over ethylene) is carried out on zeolite class (aluminosilicate) catalysts. Because of the existence of mesopores in the structure of zeolites, the shape selectivity property of zeolites towards the production of propylene, are evaluated well.<sup>6</sup> There are several types of zeolites, such as ZSM-5, ZSM-11 and ZSM-48 which have been applied in MTP/MTO processes. Most of these catalysts are poisoned rapidly by coke. It was found that ZSM-5 has a higher resistance to coke formation in both MTO and MTP processes.<sup>7</sup> Since the discovery of MTO and MTP processes, many researchers have endeavored to improve the activity of SAPO and zeolite class catalysts in order to increase the selectivity of light olefins.<sup>8–13</sup>

For instance, Liu *et al.*<sup>12</sup> added some promoters to the H-ZSM-5 catalyst by the impregnation method in order to increase the selectivity of propylene. The promoters were P, Ce, Mn, Fe, Cr, Mo, Ga, V and Ni. The P, Ce, Mn, Fe and Cr modified catalysts showed positive effects on propylene selectivity. The propylene selectivity increased in different values, and P modified catalyst presented the best outcome. The other promoters (Mo, Ga, V and Ni) showed negative effects on propylene selectivity. The reaction conditions which they applied were as follows: T = 460 °C; LHSV = 0.75 h<sup>-1</sup>;

\*Corresponding author: E-mail: naaser2010hady@gmail.com, naser\_hadi88@ms.tabrizu.ac.ir; Tel.: + 98 411 3393163; Fax: + 98 411 3340191

$P_{\text{total}} = 101.325 \text{ kPa}$ ;  $\text{MeOH} : \text{H}_2\text{O} = 1:5$  (mol:mol); the H-ZSM-5 with the Si/Al ratio of 220.

For scale up of a pilot process, the designer needs to know the reaction mechanism. This issue compelled researchers to study the mechanism of the reactions.<sup>14</sup> Since the discovery of MTH (methanol to hydrocarbons), MTG (methanol to gasoline), MTO and MTP series of reactions, many researchers have investigated various possible mechanisms of converting methanol into hydrocarbons. Although the MTP process was developed later than the MTO process, there are some references in the field of explanation of reaction mechanism of both MTO and MTP processes which will be reviewed here.

Initial works in the field of MTH mechanism were based on how methanol could reach equilibrium with dimethylether (DME), and how the initial carbon-carbon (C-C) bond could be formed.<sup>15–17</sup> Many researchers have accepted the theory of the formation of initial C-C bond mostly via carbenium ion chemistry.<sup>18–25</sup> For instance, Park and Froment,<sup>26–27</sup> who confirmed the initial C-C bond formation, suggested the MTO process consists of three reaction stages: (1) formation of DME, (2) initial C-C bond formation, and (3) subsequent conversion of the primary products into higher olefins. They developed a detailed mechanism for MTO with 726 elementary steps including protonation, deprotonation, methyl-shift, methylation, oligomerization and cracking reactions.

Bos *et al.*<sup>14</sup> and Gayubo *et al.*<sup>25</sup> believed that the light olefins, higher olefins, and paraffins are produced directly from methanol. Earlier studies have demonstrated that light olefins are formed indirectly and that their formation directly from methanol should be ignored.<sup>28–29</sup> Nowadays, nuclear magnetic resonance (NMR) studies have shown that, firstly the heavy and complex molecules are formed, which at later stages of the process, undergo cracking to produce light olefins such as ethylene, propylene and butenes.<sup>30–34,15</sup> Dessau<sup>28</sup> proposed an indirect reaction pathway in which the methylation and cracking were supposed to be the dominant reactions. This pathway predicts that propylene and butenes are the primary products, and the autocatalysis is undeniable in the reactor. It should be mentioned that first of all, Ono and Mori strongly suggested the possibility of autocatalysis.<sup>21</sup> In the last decade, another indirect pathway for MTH, known as “Hydrocarbon pool” mechanism, was introduced.<sup>15,32,34</sup> This mechanism mainly contains a central complex chemical species.<sup>35,36</sup> In the past few years it has become clear that methylbenzenes play a central role in hydrocarbon pool mechanism.<sup>15</sup> The mechanism of hydrocarbon pool proposed by Dahl and Kolboe<sup>30</sup> is shown in Fig. 1.

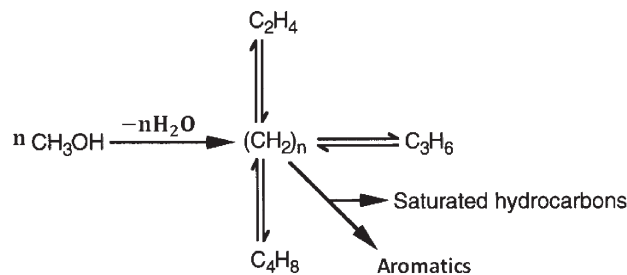

Fig. 1 – Mechanism of hydrocarbon pool<sup>15,30</sup>

Kaarsholm *et al.*<sup>37</sup> obtained some experimental data from the MTO reaction over a phosphorous-modified ZSM-5 catalyst. The experiments were carried out in a small-scale fluidized bed reactor. Their kinetic model was based on the mechanism of hydrocarbon pool. The reaction scheme that was used by Kaarsholm *et al.*<sup>37</sup> is shown in Fig. 2.

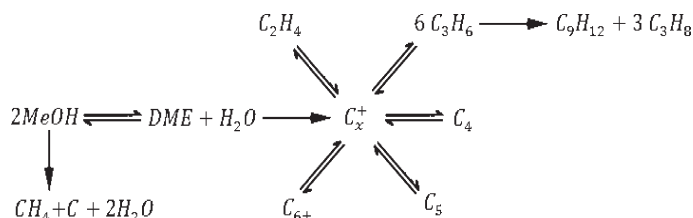

Fig. 2 – Schematic of the kinetic model proposed by Kaarsholm *et al.*<sup>37</sup>

Wu *et al.*<sup>38</sup> investigated the reaction pathway for propylene formation in methanol to propylene (MTP) process over a high silica H-ZSM-5 catalyst in a fixed bed reactor. Methylation-cracking was specified as the main reaction mechanism of a typical MTP process. Based on the reactivity of alkenes towards methylation, a reaction scheme has been presented by Wu *et al.*<sup>38</sup> containing a cycle including the consecutive methylation from butene through pentene to hexene and further to heptene, the  $\beta$ -scission of hexene and heptene for production of propylene and the  $\alpha$ -scission of hexene for generation of ethylene. The schematic diagram of dominant reactions for formation of propylene is shown in Fig. 3.

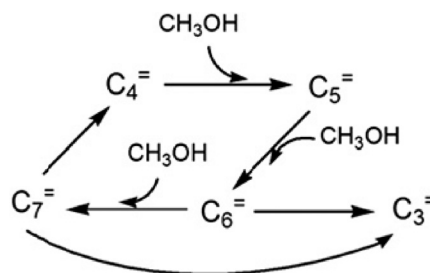

Fig. 3 – Reaction scheme for propylene formation in the MTP process proposed by Wu *et al.*<sup>38</sup>

In this paper the work of Liu *et al.*<sup>12</sup> was adopted and the H-ZSM-5 zeolite was modified by calcium (Ca), cerium (Ce), manganese (Mn), chrome (Cr), ferrum (Fe), nickel (Ni), argentum (Ag) and phosphorous (P). It was found that the propylene selectivity on the Mn/H-ZSM-5 was the highest. As mentioned previously, Liu *et al.*<sup>12</sup> found that the P modified catalyst had the best performance in propylene selectivity. This disagreement with our result returns us to the different reaction conditions and the difference between the characteristics of the H-ZSM-5 catalysts, such as the different Si/Al ratio, the surface area and the pore volume. The effect of the Mn/H-ZSM-5 on selectivity of propylene in the MTP process was investigated at several WHSV. In addition, the effect of temperature on propylene selectivity was investigated on the optimal catalyst (Mn/H-ZSM-5). A reaction pathway based on the combination of the hydrocarbon pool mechanism and the conjugate methylation-cracking mechanism was proposed for the MTP reaction. On the basis of the proposed reaction pathway, kinetic modeling was carried out for the MTP reaction using the Mn/H-ZSM-5.

## Experimental

### Catalyst preparation

The starting material for preparation of catalyst was Na-ZSM-5 with the Si/Al ratio of 200, surface area of  $400 \text{ (m}^2 \text{ g}^{-1}\text{)}$  and pore volume of  $0.16 \text{ (cm}^3 \text{ g}^{-1}\text{)}$ , which was supplied by ZEOCHEM® (Switzerland). The sample in  $\text{NH}_4$ -form was prepared by ion-exchange with a  $1 \text{ mol L}^{-1} \text{ NH}_4\text{Cl}$  (Merck, Germany) solution at  $50 \text{ }^\circ\text{C}$  for 24 h. The H-ZSM-5 ze-

olite was obtained through calcination of the  $\text{NH}_4$ -zeolite in air at  $500 \text{ }^\circ\text{C}$  for 5 h.<sup>12</sup> Modification of the H-ZSM-5 catalyst was carried out via impregnation method using nitrate of different metals and phosphoric acid.<sup>12</sup> The ethanol which was supplied by Scharlau® was added to the mixture of nitrate and the H-ZSM-5 powder to prepare the metal-modified catalysts while the phosphorous-modified catalyst was prepared by addition of distilled water instead of ethanol. The solution was stirred for 24 h. It was dried at  $100 \text{ }^\circ\text{C}$  for 11 h and calcined at  $550 \text{ }^\circ\text{C}$  for 6 h.

The surface morphology and crystallite size of the sample of the manganese-modified catalyst were determined by scanning electron microscopy (SEM) recorded on a Vega TESCAN® microscope.

### (Reactor) setup and catalytic tests

A fixed bed plug flow reactor was used to test the catalytic properties of the catalyst. The reactor was a pyrex tube 900 mm in length and 9 mm in diameter. The catalyst powder (1 g) was placed over a plug of quartz wool and inserted in the reactor. The length of the bed was 100 mm in the reactor. The reactor was placed in an electrical furnace controlled by a proportional–integral–derivative controller (PID), (Fig. 4). Feed (methanol and water) was passed through the pre-heater and mixed with carrier gas ( $\text{N}_2$ ), and then fed into the reactor bed. In order to delay catalyst deactivation and increase the selectivity of propylene, the feed consisted of 20 mol % methanol and 80 mol % water. The experiments were carried out at 400, 430, 460, 490, 520 and  $550 \text{ }^\circ\text{C}$  and at different WHSV of methanol (2.51, 5.42 and  $8.17 \text{ h}^{-1}$ ). The required pressure for

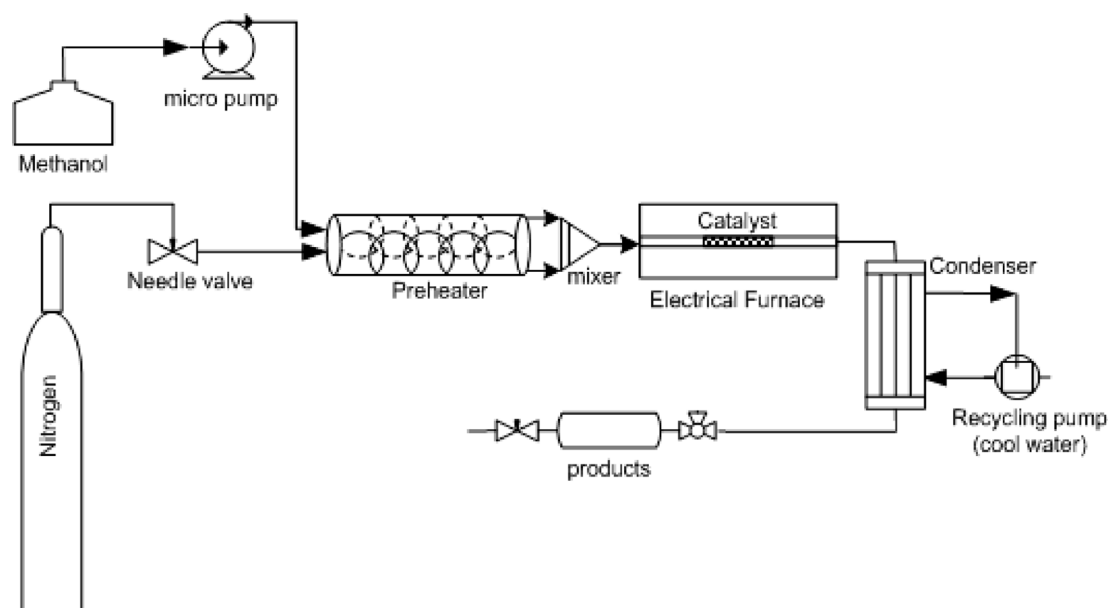

Fig. 4 – Schematic diagram of the experimental setup

the reaction was supplied by  $N_2$  inert gas. The inlet pressure of the reactor was 1.5 bar. Due to the large porosity of the quartz wool, the pressure drop in the reactor was ignored.

The effluents were condensed and analyzed by Shimadzu® 2010 plus model gas chromatograph (GC).

The GC analyzer was equipped with a HP-PLOT  $Al_2O_3$  S, Agilent capillary column (length: 50 m and internal diameter: 0.53 mm) and Flame Ionization Detector (FID). Helium was applied as the carrier gas. The reaction proceeded for 20 minutes and at this time, a portion of the gas product, which leaving the reactor was injected to the GC. This procedure was repeated for six temperatures of reaction and at three WHSV.

### Modeling of the reactor

The model of the reactor was adopted from a heterogeneous model in which the reaction was assumed to occur in the solid catalytic bed.<sup>25</sup> In this model, the space time of the feed ( $W/F_{MeOH}$ ) was considered as independent variable and the weight fractions ( $\omega_i$ ) of chemical species were considered as dependent variables.

$$\frac{d\omega_i}{d(W/F_{MeOH})} = \sum_{j=1}^n r_j \quad (1)$$

$i = 1, 2, \dots$ , number of components

where  $\omega_i$  indicates the weight fraction of chemical species,  $W/F_{MeOH}$  is the space time of the feed in  $g_{catalyst} \cdot h \cdot g_{MeOH}$ . The term indicates the rate of the  $j$ th reaction. All reactions were assumed elementary and pseudo first order reactions.

$$r_j = k_j \prod_{i=1}^m \omega_i \quad (2)$$

$j = 1, 2, \dots$ , number of reactions

where  $k_j$  is the kinetic parameter of the  $j$ th reaction.

## Results and discussion

### Modification of the H-ZSM-5 catalyst

The H-ZSM-5 zeolite was modified by 1 % wt of Ca, Ce, Mn, Cr, Fe, Ni, Ag and phosphorous (P). Fig. 5 shows the mole fraction of components which were produced by the MTP reaction over these modified catalysts. The highest mole fraction of propylene was obtained by the Mn/H-ZSM-5 and equaled 45.21 %. The enhancement of propylene selectivity can be attributed to partial elimination of the strong acid sites on the HZSM-5 catalyst. When the HZSM-5 catalyst is modified by Mn, the con-

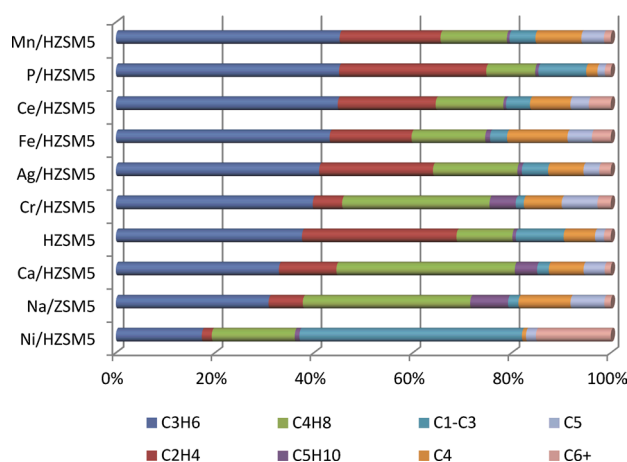

Fig. 5 – Mole fraction of products of different modified H-ZSM-5 ( $Si/Al=200$ ) catalysts for the MTP reaction. Reaction conditions:  $T = 470$  °C;  $WHSV = 2.51$   $h^{-1}$ ;  $P_{total} = 1.5$  bar;  $MeOH:H_2O = 1:4$  (mol:mol).

centration and strength of acid sites decrease. This can successfully put down the cyclization reactions which lead to the formation of aromatics.<sup>12</sup> With lower aromatics in product, higher selectivity of propylene in the MTP reaction is obtained.<sup>12</sup> Appropriate concentration and strength of acid sites can be achieved by Mn modification, which is crucial for propylene selectivity.

By means of P, Ce, Fe and Ag modified catalysts, the mole fraction of propylene reached up to 40 % and the values were about 45.09 %, 44.83 %, 43.22 % and 41.09 %, respectively. In all of the modified catalysts, the mole fraction of propylene was higher than the ethylene mole fraction, which is the characteristic point of the MTP process.

The mole fraction of ethylene was higher than butene over the five top modified catalysts while it was noticed that by some of these modified catalysts, the mole fraction of butene was higher than ethylene. Cr, Ca, Ni modified catalysts and Na/ZSM-5 (the commercial form of the zeolite) demonstrated such behavior. Ni-modified catalyst had the worst performance in propylene selectivity, even worse than the commercial form of the zeolite (Na/ZSM-5). This catalyst produced up to 43.9 % of methane and it is extremely uneconomic to apply it in the MTP process.

For more clarity only the selectivity of the most important products was calculated. Fig. 6 shows the selectivity of propylene, ethylene and butene over the modified catalysts. The highest selectivity of propylene was obtained over the Mn/H-ZSM-5 catalyst. Finally, the Mn/H-ZSM-5 was selected as the optimal catalyst for producing propylene; therefore, the kinetic study was carried out on it.



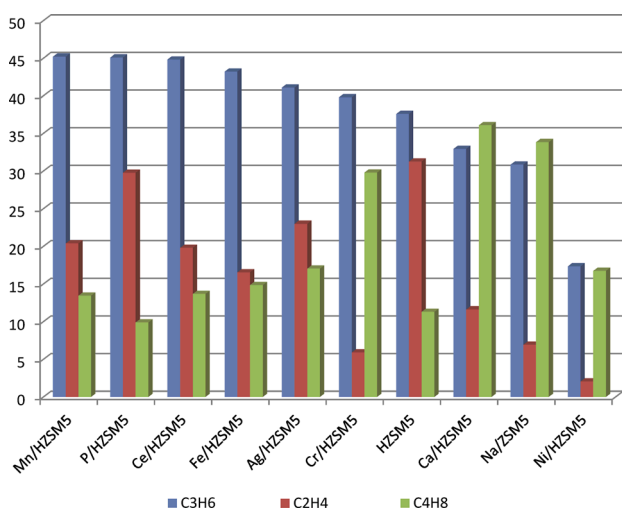
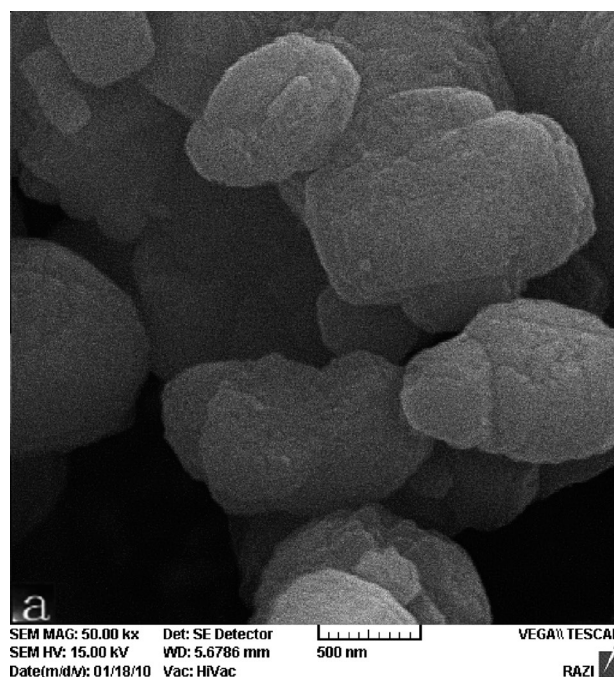

Fig. 6 – Selectivity of propylene, ethylene and butene over the different modified catalysts. Reaction conditions:  $T = 470\text{ }^{\circ}\text{C}$ ;  $\text{WHSV} = 2.51\text{ h}^{-1}$ ;  $P_{\text{total}} = 1.5\text{ bar}$ ;  $\text{MeOH:H}_2\text{O} = 1:4\text{ (mol:mol)}$ .



### Catalyst characterization

SEM images show the surface morphology and crystallite size of the H-ZSM-5 and the Mn/H-ZSM-5 catalyst with Si/Al=200 (Fig. 7). The SEM images show that the external surface of the H-ZSM-5 zeolite is clear and smooth while the external surface of the Mn/H-ZSM-5 zeolite is not, probably because of the existence of the manganese particles distributed on the Mn/H-ZSM-5 particles.

### The mechanism of reactions

A reaction pathway based on the combination of the hydrocarbon pool mechanism and the conjugate methylation-cracking mechanism was proposed for the MTP series of reactions. It was assumed that methanol initially dehydrated to form higher olefins such as butene ( $\text{C}_4^=$ ), pentene  $\text{C}_5^=$ , hexene  $\text{C}_6^=$  and heptene  $\text{C}_7^=$ .<sup>32</sup> The higher olefins underwent the methylation reactions. Thus, a series of reactions including consecutive methylation from butene through pentene to hexene and further to heptene had occurred during the reaction.<sup>38</sup> The heavier and the more complex components such as hexene  $\text{C}_6^=$  and heptene  $\text{C}_7^=$  cracked to form light olefins: ethylene and propylene. It was suggested that the  $\beta$ -scission of hexene and heptene had caused formation of propylene, and the  $\alpha$ -scission of hexene had occurred for production of ethylene.<sup>38</sup> Finally, heptene  $\text{C}_7^=$ , the heaviest and most complex component in the reaction, generated the paraffins such as ethane, propane, butanes, pentanes and the aromatics (benzene, toluene, xylenes).<sup>15</sup> Since the feed was enriched with water (MeOH:Water = 1:4, mol:mol); the formation of coke was low. The exis-

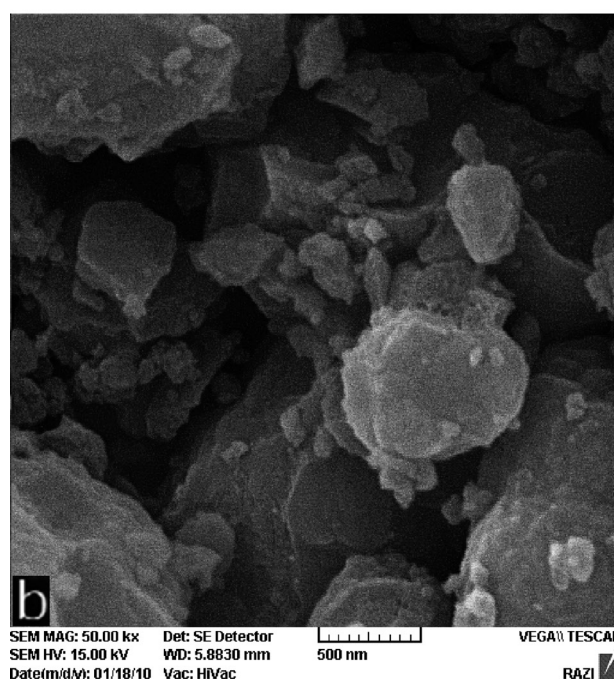
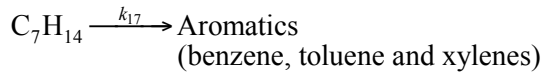
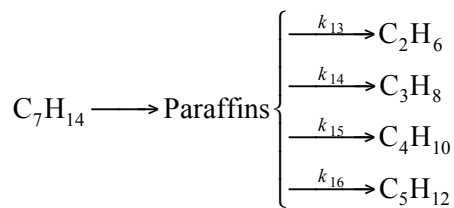
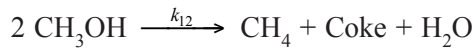
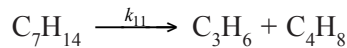
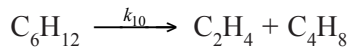
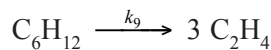
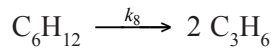
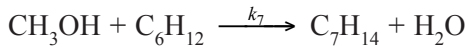
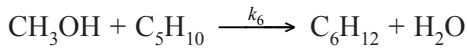
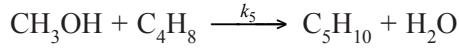
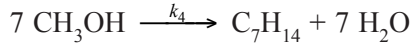
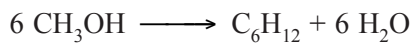
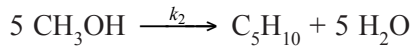
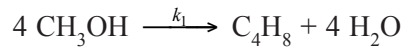

Fig. 7 – SEM images of the H-ZSM-5 catalyst (a) and the Mn/H-ZSM-5 catalyst (b)

tence of water gave a way to increase the selectivity of the light olefins by decreasing the selectivity of the aromatics.<sup>21</sup> Because of the low production of the aromatics group; the aromatics were lumped as “Aromatics”. It was proposed that the methane was generated directly via methanol and some heavier hydrocarbons named “Coke” chemical species were produced via this reaction.<sup>37</sup> The proposed mechanism of the MTP reaction included 17 reactions and 14 chemical species. This mechanism is shown according to the equations below:



### Kinetic modeling

According to equation (2), the reactions were considered elementary with pseudo first order, and by considering the reaction mechanism, the following equations could be obtained.

$$r_1 = k_1 \omega_{\text{MeOH}} \quad (3)$$

$$r_2 = k_2 \omega_{\text{MeOH}} \quad (4)$$

$$r_3 = k_3 \omega_{\text{MeOH}} \quad (5)$$

$$r_4 = k_4 \omega_{\text{MeOH}} \quad (6)$$

$$r_5 = k_5 \omega_{\text{MeOH}} \omega_{\text{C}_4\text{H}_8} \quad (7)$$

$$r_6 = k_6 \omega_{\text{MeOH}} \omega_{\text{C}_5\text{H}_{10}} \quad (8)$$

$$r_7 = k_7 \omega_{\text{MeOH}} \omega_{\text{C}_6\text{H}_{12}} \quad (9)$$

$$r_8 = k_8 \omega_{\text{C}_6\text{H}_{12}} \quad (10)$$

$$r_9 = k_9 \omega_{\text{C}_6\text{H}_{12}} \quad (11)$$

$$r_{10} = k_{10} \omega_{\text{C}_6\text{H}_{12}} \quad (12)$$

$$r_{11} = k_{11} \omega_{\text{C}_7\text{H}_{14}} \quad (13)$$

$$r_{12} = k_{12} \omega_{\text{MeOH}} \quad (14)$$

$$r_{13} = k_{13} \omega_{\text{C}_7\text{H}_{14}} \quad (15)$$

$$r_{14} = k_{14} \omega_{\text{C}_7\text{H}_{14}} \quad (16)$$

$$r_{15} = k_{15} \omega_{\text{C}_7\text{H}_{14}} \quad (17)$$

$$r_{16} = k_{16} \omega_{\text{C}_7\text{H}_{14}} \quad (18)$$

$$r_{17} = k_{17} \omega_{\text{C}_7\text{H}_{14}} \quad (19)$$

The method for estimation of the kinetic parameters consisted of solving the mass conservation equation for each component. For parameter estimation, the rates of reactions were considered as power law relations. By means of eq. (1), the following relations could be written for each component:

$$\frac{d\omega_{\text{MeOH}}}{d(W/F_{\text{MeOH}})} = - (4r_1 + 5r_2 + 6r_3 + 7r_4 + r_5 + r_6 + r_7 + 2r_{12}) \quad (20)$$

$$\frac{d\omega_{\text{C}_2\text{H}_4}}{d(W/F_{\text{MeOH}})} = 3r_9 + r_{10} \quad (21)$$

$$\frac{d\omega_{\text{C}_3\text{H}_6}}{d(W/F_{\text{MeOH}})} = 2r_8 + r_{11} \quad (22)$$

$$\frac{d\omega_{\text{C}_4\text{H}_8}}{d(W/F_{\text{MeOH}})} = r_1 - r_5 + r_{10} + r_{11} \quad (23)$$

$$\frac{d\omega_{\text{C}_5\text{H}_{10}}}{d(W/F_{\text{MeOH}})} = r_2 + r_5 - r_6 \quad (24)$$

$$\frac{d\omega_{\text{CH}_4}}{d(W/F_{\text{MeOH}})} = r_{12} \quad (25)$$

$$\frac{d\omega_{\text{C}_2\text{H}_6}}{d(W/F_{\text{MeOH}})} = r_{13} \quad (26)$$

$$\frac{d\omega_{\text{C}_3\text{H}_8}}{d(W/F_{\text{MeOH}})} = r_{14} \quad (27)$$

$$\frac{d\omega_{\text{C}_4\text{H}_{10}}}{d(W/F_{\text{MeOH}})} = r_{15} \quad (28)$$

$$\frac{d\omega_{\text{C}_5\text{H}_{12}}}{d(W/F_{\text{MeOH}})} = r_{16} \quad (29)$$

$$\frac{d\omega_{\text{Aromatics}}}{d(W/F_{\text{MeOH}})} = r_{17} \quad (30)$$

$$\frac{d\omega_{\text{Coke}}}{d(W/F_{\text{MeOH}})} = r_{12} \quad (31)$$

$$\frac{d\omega_{\text{C}_6\text{H}_{12}}}{d(W/F_{\text{MeOH}})} = r_3 + r_6 - r_7 - r_8 - r_9 - r_{10} \quad (32)$$

$$\frac{d\omega_{\text{C}_7\text{H}_{14}}}{d(W/F_{\text{MeOH}})} = r_4 + r_7 - r_{11} - r_{13} - r_{14} - r_{15} - r_{16} - r_{17} \quad (33)$$

The mechanism could be made more flexible by assumption of the quasi-steady state condition on hexene ( $C_6^-$ ) and heptene ( $C_7^-$ ) in eqs. (32) and (33). This assumption is justifiable in the case of the high reactivity of hexene ( $C_6^-$ ) and heptene ( $C_7^-$ ) and the central role of these heavy olefins in our mechanism. These two components would be assumed as unstable reactive intermediates. In other words, by considering the equality between the generation rates of hexene ( $C_6^-$ ) and heptene ( $C_7^-$ ) and their consuming rates, and by insertion of the rate equations, the following equations could be obtained:

$$\omega_{C_6H_{12}} = \frac{k_3\omega_{MeOH} + k_6\omega_{MeOH}\omega_{C_5H_{10}}}{k_7\omega_{MeOH} + k_8 + k_9 + k_{10}} \quad (34)$$

$$\omega_{C_7H_{14}} = \frac{k_4\omega_{MeOH} + k_7\omega_{MeOH}\omega_{C_6H_{12}}}{k_{11} + k_{13} + k_{14} + k_{15} + k_{16} + k_{17}} \quad (35)$$

By insertion of eq. (34) in (35), it could be concluded that:

$$\omega_{C_7H_{14}} = \frac{k_4\omega_{MeOH} + k_7\omega_{MeOH} \left( \frac{k_3\omega_{MeOH} + k_6\omega_{MeOH}\omega_{C_5H_{10}}}{k_7\omega_{MeOH} + k_8 + k_9 + k_{10}} \right)}{k_{11} + k_{13} + k_{14} + k_{15} + k_{16} + k_{17}} \quad (36)$$

By elimination of the terms of  $\omega_{C_6H_{12}}$  and  $\omega_{C_7H_{14}}$  in the eqs. (20)–(33), the regenerated equations could be obtained. It should be noted that all calculations were carried out in the case of water-free base. The regenerated differential equations (20–33) corresponding to the mass conservation equations of the chemical species, were solved by ode15s function in MATLAB®. The objective function which was used to minimize the deviation between the experimental and the calculated weight fractions of the chemical species is according to eq. (37)

$$OF = \sum_{i=1}^m \sum_{j=1}^p (\omega_{i,j(exp)} - \omega_{i,j(cal)})^2 / mp \quad (37)$$

where  $\omega_{i,j(cal)}$  are the values of the calculated weight fractions obtained by solving the regenerated mass conservation equations (20–33) for component  $i$  in the experimental point  $j$  corresponding to a specified value of space time ( $W/F_{MeOH}$ ),  $\omega_{i,j(exp)}$  are the values of experimental weight fractions obtained for six different temperatures with three space times (0.12, 0.18 and 0.40  $g_{catalyst} \cdot h \cdot g_{MeOH}^{-1}$ ). To reduce the calculation of the kinetic parameters, reparametrization was carried out for estimation of the pre exponential factor ( $k_0$ ) and the activation energy ( $E$ ). The reparametrized relationship between kinetic parameters and temperature is:

$$k_i = k_{0i} \exp \left[ \frac{-E}{R} \left( \frac{1}{T} - \frac{1}{T_m} \right) \right] \quad (38)$$

Thus the kinetic parameters for each reaction involved in the reaction mechanism optimized at a reference temperature,  $T_m = 475$  °C. The kinetic parameters were estimated using hybrid genetic algorithm in MATLAB® optimization Toolbox. The procedure for determination of the kinetic parameters was as follows: At first, the genetic algorithm (GA) was run for sets of data of each reaction temperature and the GA running was repeated ten times for each reaction temperature. The values of objective function were compared in each GA running and its minimum value was selected, because the minimum value of the objective function represented the minimum deviation between the calculated and the real kinetic parameters. The optimal parameters used in GA running were: population size = 100; generation = 200; crossover fraction = 0.85; crossover function: crossover arithmetic. The other parameters in GA were held at their default values. At the end of the procedure, the hybrid function (fminsearch) existing in the MATLAB® optimization Toolbox, was applied to optimize the kinetic parameters twice. The average corresponding value of the objective function was  $5.35 \cdot 10^{-3}$ .

The calculated values of the pre exponential factor, the activation energy and the deviation between the real and the calculated kinetic parameters of each reaction are reported in Table 1.

Table 1 – Calculated kinetic parameters and deviation between the real and calculated parameters

Reaction number	calc. $k_0$ (h <sup>-1</sup> )	dev. with real $k_0$ (h <sup>-1</sup> )	calc. $E$ (kJ mol <sup>-1</sup> )	dev. with real $E$ (kJ mol <sup>-1</sup> )
1	0.86	-0.010	9.56	+0.034
2	0.21	-0.009	10.62	+0.069
3	3.28	-0.015	10.30	+0.072
4	2.39	-0.002	8.04	-0.018
5	0.69	+0.001	10.03	+0.082
6	1.66	-0.007	7.96	-0.010
7	1.40	-0.001	10.86	+0.076
8	2.65	+0.014	11.37	+0.094
9	0.69	-0.006	11.25	+0.084
10	0.48	+0.001	11.18	+0.096
11	2.46	+0.019	10.20	+0.002
12	0.23	-0.018	10.88	+0.012
13	0.39	-0.007	10.72	+0.009
14	0.95	+0.002	13.63	+0.098
15	2.25	-0.017	9.45	+0.001
16	1.63	-0.006	10.70	+0.065
17	1.63	-0.004	12.41	+0.093

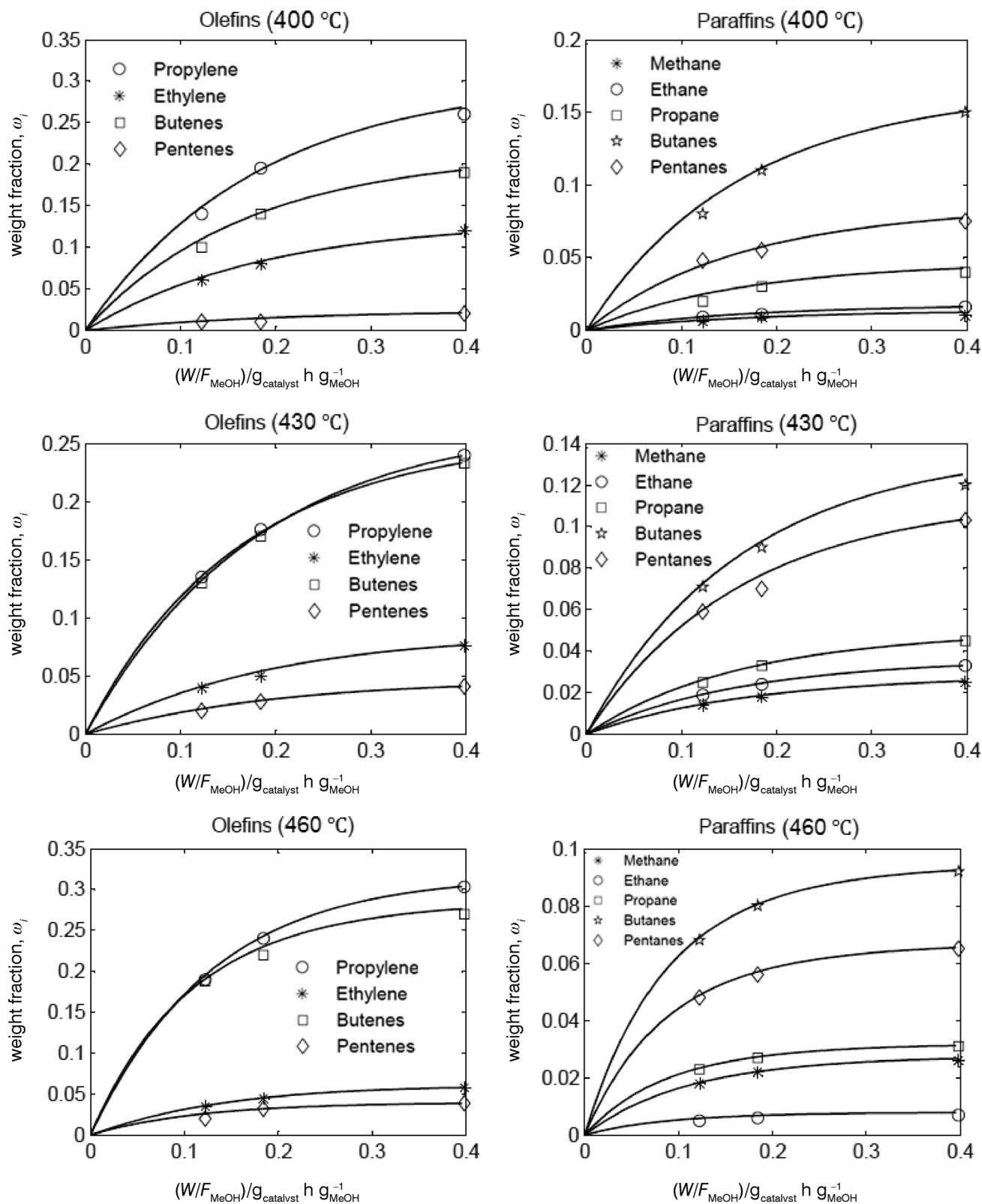

From the values of the kinetic parameters, it can be concluded that the formation of propylene takes place mainly from the cracking of hexene and to a less extent from the cracking of heptene. At  $T_m$  the kinetic parameters corresponding to the formation of propylene from hexene and from heptene are  $k_8 = 2.65 \text{ h}^{-1}$ ,  $k_{11} = 2.46 \text{ h}^{-1}$  respectively. Similar to

propylene, the ethylene is produced from the cracking of hexene. Low reaction rate of steps 2, 12 and 13 which refer to the formation of pentene directly from methanol and the formation of paraffins such as methane, ethane and the chemical species of coke is also notable. The corresponding kinetic parameters at  $T_m$ , are  $k_2 = 0.21 \text{ h}^{-1}$ ,  $k_{12} = 0.23 \text{ h}^{-1}$  and



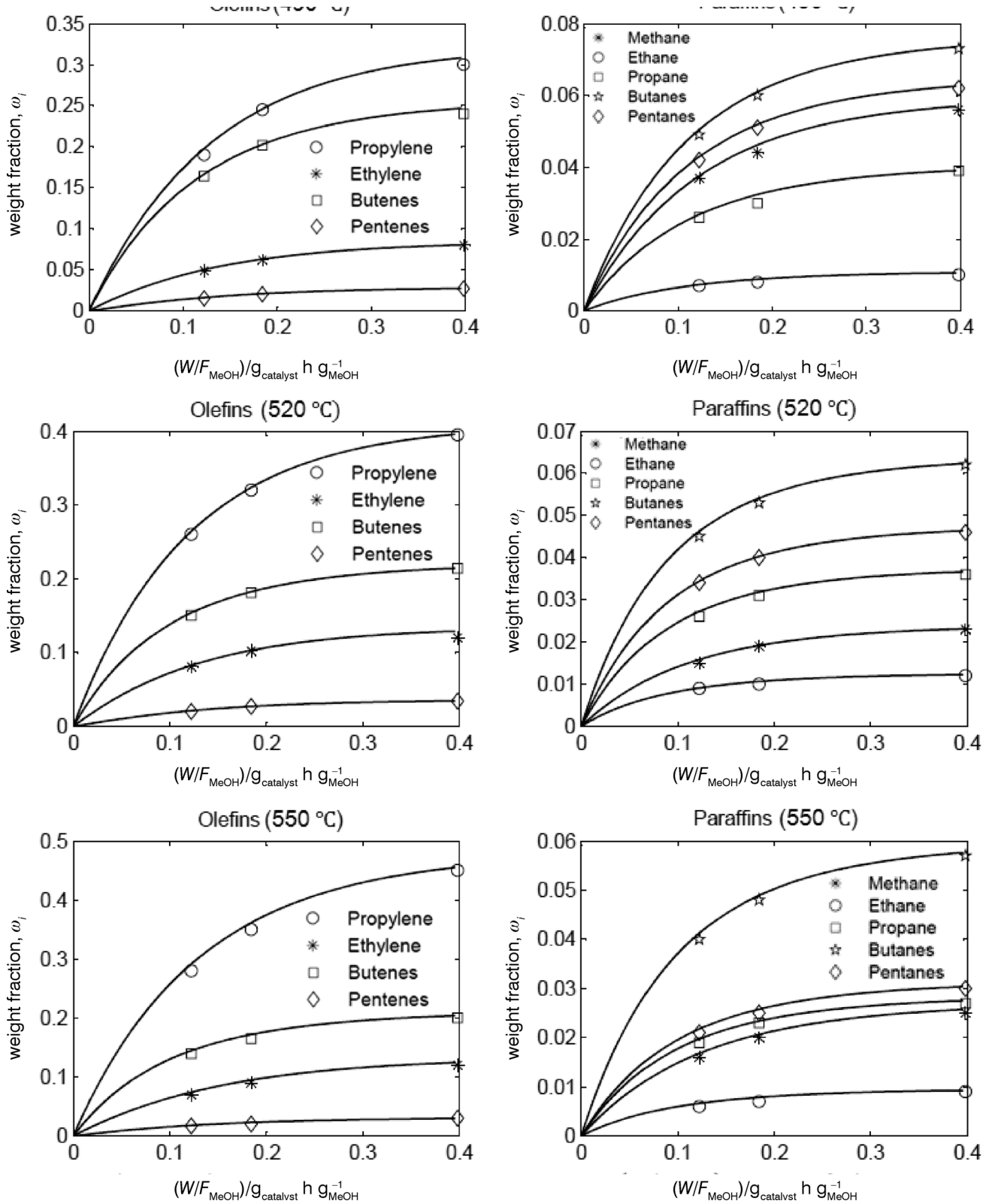

Fig. 8 – Weight fractions of each olefin and paraffin versus space time of the reactions for different reaction temperatures. Points: experimental results. Lines: calculated with the kinetic model

$k_{13} = 0.39 \text{ h}^{-1}$ . Also, the rate of the  $\beta$ -scission of hexene in producing propylene ( $k_8 = 2.65 \text{ h}^{-1}$ ) is greater than the  $\alpha$ -scission of the hexene for formation of ethylene ( $k_9 = 0.69 \text{ h}^{-1}$ ) at the reference tem-

perature. Generally, the rates of methylation reactions are less than those of the dehydration reactions.

Fig. 8 represents the weight fraction of the main product distribution versus space time of the

reactions at six temperatures. In these figures, the experimental and the calculated values are shown by points and lines, respectively. A good agreement is observed between the experimental and the calculated data obtained from kinetic model.

Effect of temperature on the selectivity of propylene, ethylene and butene is shown in Fig. 9. The selectivity of propylene and the conversion of the feed increase steadily with temperature. With increasing the temperature, some cracking reactions take place and the selectivity of butene decreases. The propylene selectivity is higher than ethylene and butene in all temperatures, which is a characteristic point of the MTP reaction.

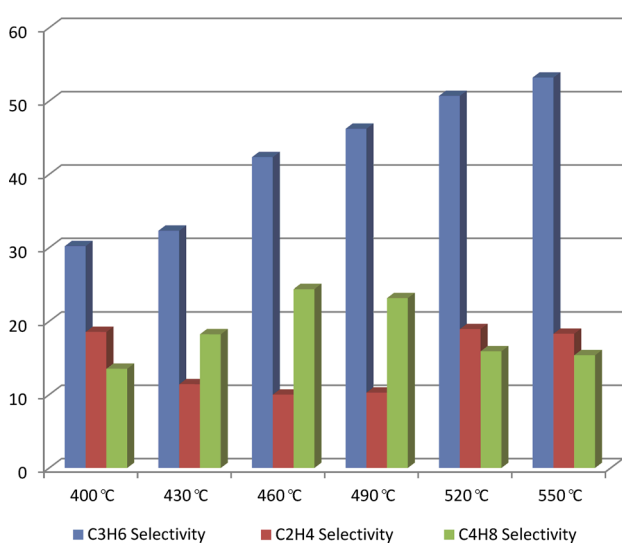

Fig. 9 – Effect of temperature on selectivity of propylene, ethylene and butene over Mn/H-ZSM-5. Reaction conditions:  $WHSV = 2.51 \text{ h}^{-1}$ ;  $P_{total} = 1.5 \text{ bar}$ .  $MeOH:H_2O = 1:4 \text{ (mol:mol)}$ .

## Conclusion

– Commercial zeolite (Na-ZSM-5) with the Si/Al ratio of 200 was used to prepare the modified catalysts (M/H-ZSM-5) by means of impregnation method of phosphorous, Ca, Mn, Cr, Fe, Ni, Ag and Ce.

– Comparison between the different modified catalysts revealed that the Mn/H-ZSM-5 catalyst had the highest selectivity to propylene. Therefore, it was selected as the optimal catalyst and the kinetic modeling was carried out for the reactions that evolved it.

– A kinetic model and reaction mechanism were proposed for methanol to propylene process over the Mn/H-ZSM-5 catalyst on the basis of the combination of the hydrocarbon pool mechanism and conjugate methylation/cracking mechanism.

– The kinetic parameters were estimated successfully using the hybrid genetic algorithm.

– Good agreement was observed between the experimental and the calculated profiles of the species.

– The selectivity of propylene increased gradually with temperature.

## Nomenclature

- $E$  – activation energy,  $\text{kJ mol}^{-1}$   
 $F_{MeOH}$  – mass flow of methanol in the feed,  $\text{g}_{MeOH} \text{ h}^{-1}$   
 $k_j$  – kinetic parameter for the  $j$ th chemical reaction,  $\text{h}^{-1}$   
 $k_0$  – pre exponential factor of the kinetic parameters,  $\text{h}^{-1}$   
 $m$  – number of chemical species  
 $MeOH$  – methanol chemical species  
 $n$  – number of reactions  
 $OF$  – objective function  
 $p$  – number of experimental data related to a specified space time and temperature  
 $R$  – universal constant of gases,  $8.314 \text{ J mol}^{-1} \text{ K}^{-1}$   
 $r_j$  – reaction rate for the  $j$ th chemical reaction,  $\text{g}_i \text{ h}^{-1} \text{ g}_{Catalyst}^{-1}$   
 $T$  – reaction temperature,  $\text{K}$   
 $T_m$  – reference temperature of reparametrization relationship,  $\text{K}$   
 $W$  – catalyst weight,  $\text{g}$   
 $\omega_i$  – weight fraction of the  $i$ th chemical species,  $\text{g}_i \text{ g}_{Total}^{-1}$

## References

- Mei, C. S., Wen, P., Liu, Z., Wang, Y., Yang, W., Xie, Z., Hua, W., Gao, Z., *J. Catal.* **258** (2008) 243.
- Baliban, R. C., Elia, J. A., Weekman, V., Floudas, C. A., *Computers and Chem. Eng.* **47** (2012) 29.
- Xiang, D., Qian, Y., Mao, Y., Yang, S., *Appl. Energy* **113** (2014) 639.
- Aguayo, A. T., Alonso, A., Atutxa, A., Bilbao, J., *Catal. today* **106** (2005) 112.
- Abwahabi, S. M., Froment, G. F., *Ind. Eng. Chem. Res.* **43** (2004) 5098.
- Stöcker, M., *Microporous Mesoporous Mater.* **29** (1999) 3.
- Froment, G. F., *Chem. Eng. Sci.* **47** (1992) 2163.
- Chang, C. D., Chu, C. T. W., Socha, R. F., *J. Catal.* **86** (1984) 289.
- Al-Jarallah, A. M., El-Nafaty, U. A., Abdillahi, M. M., *Appl. Catal., A* **154** (1997) 117.
- Zhao, T. S., Takemoto, T., Yoneyama, Y., Tsubaki, N., *Catal. Commun.* **7** (2006) 647.
- Kaarsholm, M., Joensen, F., Nerlov, J., Cenni, R., Chaouki, J., Patience, G. S., *Chem. Eng. Sci.* **62** (2007) 5527.
- Liu, J., Zhang, C., Shen, Z., Hua, W., Tang, Y., Shen, W., Yue, Y., Xu, H., *Catal. Commun.* **10** (2009) 1506.
- Zhang, S., Zhang, B., Gao, Z., Han, Y., *React. Kinet. Mech. Cat.* **99** (2010) 447.

14. Bos, A. N. R., Tromp, P. J. J., Akse, H. N., *Ind. Eng. Chem. Res.* **34** (1995) 3808.
15. Olsbye, U., Bjørgen, M., Svelle, S., Lillerud, K. P., Kolboe, S., *Catal. today* **106** (2005) 108.
16. Derouane, E. G., Nagy, J. B., Dejajve, P., van Hooff, J. H. C., Spekman, B. P., Ve'rine, J. C., Naccache, C., *J. Catal.* **53** (1978) 40.
17. Chang, C. D., Chu, C. T. W., *J. Catal.* **79** (1983) 244.
18. Chang, C. D., Silvestri, A. J., *J. Catal.* **47** (1977) 249.
19. Chen, N., Reagan, W., *J. Catal.* **59** (1979) 123.
20. Chang, C. D., *Chem. Eng. Sci.* **35** (1979) 619.
21. Ono, Y., Mori, T., *J. Chem. Soc., Faraday Trans.* **77** (1981) 2209.
22. Mihail, R., Straja, S., Maria, G. H., Musca, G., Pop, G. R., *Chem. Eng. Sci.* **38** (9) (1983) 1581.
23. Iordache, O. M., Maria, G. C., Pop, G. L., *Ind. Eng. Chem. Res.* **27** (1988) 2218.
24. Sedran, U., Mahay, A., De Lasa, H. I., *Chem. Eng. Sci.* **45** (5) (1990) 1161.
25. Gayubo, A. G., Aguayo, A. T., Sanchez, A. E., Tarrío, A. M., Bilbao, J., *Ind. Eng. Chem. Res.* **39** (2000) 292.
26. Park, T. Y., Froment, G. F., *Ind. Eng. Chem. Res.* **40** (2001) 4172.
27. Park, T. Y., Froment, G. F., *Ind. Eng. Chem. Res.* **40** (2001) 4187.
28. Dessau, R. M., *J. Catal.* **99** (1986) 111.
29. Haw, J. F., Marcus, D. M., Kletnieks, P. W., *J. Catal.* **244** (2006) 130.
30. Dahl, I. M., Kolboe, S., *Catal. Lett.* **20** (1993) 329.
31. Dahl, I. M., Kolboe, S., *J. Catal.* **149** (1994) 458.
32. Dahl, I. M., Kolboe, S., *J. Catal.* **161** (1996) 304.
33. Wang, W., Buchholz, A., Seiler, M., Hunger, M., *J. Am. Chem. Soc.* **125** (2003) 15260.
34. Wang, W., Jiang, Y., Hunger, M., *Catal. Today* **113** (2006) 102.
35. Arstad, B., Kolboe, S., *J. Am. Chem. Soc.* **123** (2001) 8137.
36. Sassi, A., Wildman, M. A., Ahn, H. J., Prasad, P., Nicholas, J. B., Haw, J. F., *J. Phys. Chem. B* **106** (2002) 2294.
37. Kaarsholm, M., Rafii, B., Joensen, F., Cenni, R., Chaouki, J., Patience, G. S., *Ind. Eng. Chem. Res.* **45** (2010) 81.
38. Wu, W., Guo, W., Xiao, W., Luo, M., *Chem. Eng. Sci.* **66** (2011) 4722.