

# NADOMJESNI MODEL TLA ZASNOVAN NA UMJETNIM NEURONSKIM MREŽAMA

## SUBSTITUTIONAL MODEL OF THE SOIL BASED ON ARTIFICIAL NEURAL NETWORKS

Mr. sc. Tomislav Barić, doc. dr. sc. Vedran Boras, prof. dr. sc. Radoslav Galić,  
Sveučilište J. J. Strossmayer, Elektrotehnički fakultet,  
Kneza Trpimira 2 b, 31000 Osijek, Hrvatska

U radu je prikazana interpretacija rezultata mjerenja specifičnog otpora tla primjenom umjetnih neuronskih mreža. Model zasnovan na umjetnim neuronskim mrežama nadomješta tlo koje se fizikalno može smatrati kao dvoslojni medij s vertikalnom promjenom specifičnog električnog otpora i s vodoravnom granicom među slojevima. Učenje umjetne neuronske mreže provedeno je pod nadzorom sa skupom ulaznih podataka koji su dobiveni na temelju vrlo točnog teorijskog modela dvoslojnog tla. Predloženi algoritam, koji aproksimira nelinearne karakteristike tla koristeći umjetne neuronske mreže, pouzdano procjenjuje parametre tla i specifičnu električnu otpornost tla. Primjena nadomjesnog modela tla zasnovanog na neuronskim mrežama prikazana je na praktičnom primjeru određivanja parametara dvoslojnog tla iz mjernih podataka dobivenih Wennerovom tehnikom mjerenja specifičnog otpora tla. Radi jednostavnosti izlaganja i usporedivosti modela strujne sonde (štapovi) su nadomještene kuglastim elektrodama, odnosno točkastim izvorima polja. Dobiveni rezultati su prikazani analitički i grafički te diskutirani.

This paper presents an interpretation of the results of measurement of specific soil resistivity by means of artificial neural networks. The model based on artificial neural networks replaces the soil which can be physically considered a two-layer medium with a vertical change of the specific electric resistivity and a horizontal boundary line between the layers. Learning of the neural network was performed under supervision using the input dataset obtained by means of a very accurate theoretical model of the double-layer soil. The proposed algorithm that approximates non-linear soil properties using the artificial neural network is reliable in assessment of the soil parameters and specific electric soil resistivity. Application of the substitutional model of the soil based on neural networks is demonstrated by a realistic example, determination of parameters of the double-layer soil from the measured data obtained by the Wenner technique for measuring the specific soil resistivity. For simplicity of presentation and model comparability, the current probes (poles) are replaced by the ball electrodes, i.e. spot field sources. The results obtained are analytically and graphically presented and discussed.

**Ključne riječi:** dvoslojno tlo, specifični električni otpor tla, umjetne neuronske mreže, Wennerova mjerna metoda

**Key words:** artificial neural networks, double-layer soil, specific electrical soil resistivity, Wenner measuring method



## 1 UVOD

Mjerenje specifičnog električnog otpora tla nezaobilazan je postupak tijekom sakupljanja podataka vezanih za projektiranje i izgradnju sustava uzemljenja [1] ili u slikovnoj dijagnostici sastava tla. Točnost aproksimacije sustava tla na temelju ulaznih mjerenih podataka izrazito je važna zbog njenog izravnog utjecaja na točnost proračuna parametara uzemljivača i na cijenu izvedbe uzemljivača. Izvjestan broj mjernih tehnika specifičnog električnog otpora tla opisan je detaljno u [2]. Ova norma daje za dvoslojni model tla prikladne metode za određivanje specifičnog otpora gornjeg i donjeg sloja tla, kao i debljinu gornjeg sloja tla. U uporabi prevladava nekoliko električnih mjernih tehnika mjerenja specifične električne otpornosti tla [2] i [3]: Wenner, Schlumberger, Dipol-Dipol i Lee, koje tijekom mjerenja koriste raspored elektroda kao na slici 1. Najviše preporučivana i najčešće korištena tehnika mjerenja specifičnog otpora tla je Wennerova mjerna metoda [4], [5], [6], [7] i [8] u simetričnoj konfiguraciji s četiri elektrode kako je prikazano na slici 1, a značajka ove konfiguracije je jednak razmak  $a$  između susjednih elektroda.

Kod ovih metoda uobičajeno se pretpostavlja da izmjerena specifična otpornost za dani razmak elektroda  $a$  predstavlja prividnu specifičnu otpornost tla. Niz mjerenja uzetih za različite razmake mjernih elektroda daje niz otpornosti (kvocijenata mjerenih napona između naponskih elektroda i istodobno utisnutih struja u tlo) koje, kada se nacrtaju u ovisnosti o razmaku elektroda, ukazuju da li postoje različiti slojevi tla, te daju ideju o mogućim iznosima njihovih specifičnih otpornosti i mogućim dubinama tih slojeva [2]. Tako dobiveni podaci se na temelju teorijski pretpostavljenih modela tla koriste za izračunavanje prividnog specifičnog otpora tla. Jednom tako uspostavljena veza između prividne specifične otpornosti tla i mjernih podataka omogućava dobivanje krivulja koje prikazuju ovisnost prividne specifične otpornosti o razmaku između elektroda. Analizom dobivenih krivulja dobivaju se podaci od interesa (specifični električni otpor slojeva tla i njihove debljine). U tu svrhu koriste se gotove krivulje dobivene teorijskim modelima, a koje prikazuju istovrsnu ovisnost. Navedene krivulje iskazane su parametarski kako bi iznalaženje podataka od interesa bilo olakšano.

Uspoređivanjem krivulja prividne specifične otpornosti tla dobivenih mjerenjem s krivuljama dobivenih teorijskim modelom donosi se zaključak o iznosima željenih parametara. Drugi način određivanja traženih parametara temelji se na njihovom analitičkom određivanju korištenjem

## 1 INTRODUCTION

Measuring the specific electrical soil resistivity is an unavoidable procedure in acquiring data related to design and building of the grounding system [1] as well as in image diagnostics of the soil composition. Accuracy of approximation of the soil system based on the input measured data is extremely important as it directly affects the accuracy of calculation of the ground conductor parameters and the ground conductor price. A certain number of techniques for measuring the specific electrical soil resistivity is described in detail in [2]. For a double-layer soil model, this standard gives suitable methods for determining the specific resistivity of the upper and lower soil layer, as well as the thickness of the upper soil layer. Several electrical measuring techniques are most frequently used for measuring the specific electrical soil resistivity [2] and [3]: Wenner, Schlumberger, Dipol-Dipol and Lee, whose electrode configuration during measuring is as per Figure 1. The most recommended and most frequently used technique for measuring the specific soil resistivity is the Wenner measuring method [4], [5], [6], [7] and [8] in symmetrical configuration with four electrodes as shown in Figure 1; this configuration is characterized by an equal distance  $a$  between adjacent electrodes.

By these methods, it is normally assumed that the measured specific resistivity for the distance between the electrodes,  $a$ , represents the apparent specific soil resistivity. In measurements performed for various distances between the electrodes, various resistivities (quotients of the measured voltage between the voltage electrodes and the currents that are simultaneously introduced into the soil) have been obtained. These values, as per the drawing that relates them to the distance between the electrodes, indicate the presence of different soil layers and provide an idea of the amounts of their specific resistivities and of the depths of these layers [2]. Based on the theoretical soil models, such obtained data are used for calculation of the apparent specific soil resistivity. The established relationship between the apparent specific soil resistivity and the measured data enables one to obtain the curves that show the relationship between the apparent specific resistivity and distance between the electrodes. Analysis of the obtained curves provides the data of interest (specific electrical resistivity of the soil layers and their thicknesses). For this purpose, curves obtained by means of theoretical models are used, with the same type of correlation. These curves are parametrically presented, so that discovery of the data of interest is facilitated.

teorijskog modela tla i za njega prilagođenog matematičkog instrumentarija [2]. Navedena tehnika je veoma složena zbog korištenja složenog matematičkog instrumentarija, te se češće pribjegava grafičkom postupku.

By comparison of the apparent specific soil resistivity obtained by measuring with the curves obtained by a theoretical model, a conclusion about the values of the desired parameters is reached. The other way of determining the desired parameters is based on their analytical determination, using the theoretical soil model and mathematical equipment adapted to the model [2]. This technique is very complex due to the use of complex mathematical equipment, and therefore the graphical procedure is used more often.

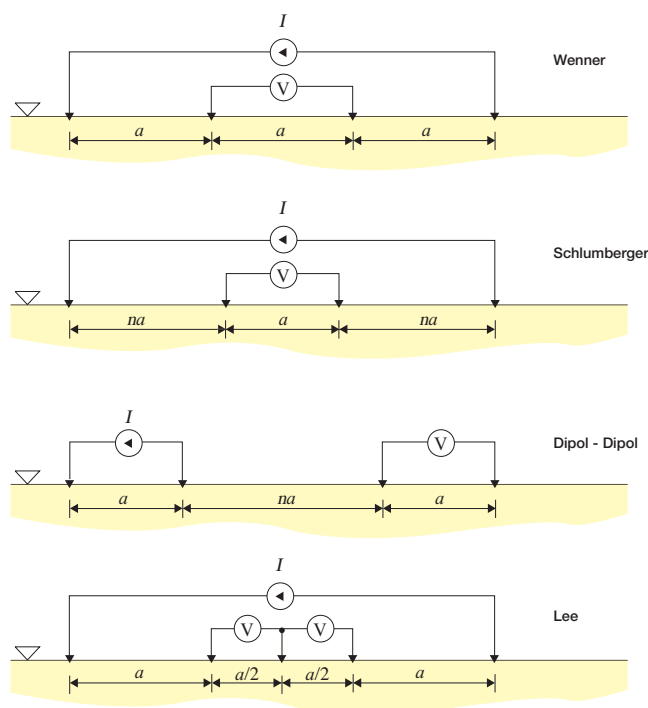

**Slika 1**  
Različite konfiguracije elektroda za ispitivanje specifične otpornosti tla

**Figure 1**  
Various electrode configurations for examining the specific soil resistivity

Pri tome se tolerira pogreška oko 10 %, (a ponekad i veća) u određivanju parametara. Međutim, treba imati na umu da se mjerni podaci odnose na mjerenje stvarnog tla, čija je heterogenost najčešće aproksimirana na vertikalnu promjenu specifične električne otpornosti. Preostala zanemarena heterogenost predstavlja mjernu smetnju, jer nije uvažena u modelu. Osim toga mjerenje uvijek sadrži i mjernu nesigurnost uzrokovanu mjernim instrumentima, lutajućim strujama u tlu itd. Iz svega navedenog mjerni podaci u sebi sadrže mjernu nesigurnost, koja otežava tumačenje i određivanje željenih parametara.

Navedena mjerna nesigurnost može biti tolika da se konačni sud neovisno o izabranom načinu iznalaženja željenih podataka prepušta korisniku. Iz tog razloga ukazuje se potreba za iznalaženjem postupka koji je prikladan za primjenu na osobnom računalu (PC), a koji omogućava

An error of ca. 10 % (sometimes even higher) in determination of the parameters is tolerated. However, it must be taken into account that the measured data refer to measuring the realistic soil, whose heterogeneity is usually approximated to the vertical change of specific electrical resistivity. The remaining disregarded heterogeneity is a measuring disturbance, as it is not considered in the model. Besides this, measuring always includes a measuring uncertainty caused by the measuring instruments, leakage currents in the soil etc. Due to the aforementioned, the measured data contain a measuring uncertainty that makes interpretation and determination of the desired parameters more difficult.

The measuring uncertainty can be so high that the final decision, regardless of the selected method for obtaining the desired data, is left to the user. Therefore, a process suitable for application on

učinkoviti način određivanja željenih parametara iz mjernih podataka u slučajevima kada mjerni podaci sadrže visok stupanj mjerne nesigurnosti, odnosno šum. Značajni su rezultati i doprinos domaćih istraživanja automatske interpretacije podataka izmjerenih geoelektričnim sondiranjem direktnim i iterativnim postupkom aproksimacije tla višeslojnim, navedenih u [9] i [10].

## 2 UMJETNE NEURONSKE MREŽE

S obzirom da u slučaju kada mjerni podaci sadrže visok stupanj mjerne nesigurnosti, dvosmislenost parametara mora riješiti korisnik, koji se pri tome povodi prethodnim iskustvom, odnosno stečenim znanjem. Postavlja se pitanje: Može li se iskustvo čovjeka za takvu vrstu odlučivanja replicirati korištenjem umjetnih neuronskih mreža? Odgovor na to pitanje tema je ovog članka. Kao što i sam naziv sugerira, termin umjetna neuronska mreža upućuje na kopiju biološke neuronske mreže prisutne u mozgu. Prednost umjetne neuronske mreže nad analitičkim modelima i klasičnim algoritmima je u tome što ima sposobnost učenja, kao i donošenja odluka u slučaju kada postoji neodređenost. Formalni opis umjetnog neurona dan je davne 1943. godine [11], a njegova znatnija primjena počela je krajem prošlog stoljeća u robotici i automatskom prepoznavanju uzoraka.

Najčešće korištena struktura neuronskih mreža je višeslojna neuronska mreža (MLP-*Multilayer Perceptrons*). Takva struktura se sastoji od ulaznog sloja neurona, jednog ili više slojeva skrivenih neurona te jednog izlaznog sloja neurona. Struktura jedne takve neuronske mreže [11] prikazana je na slici 2.

a personal computer (PC) needs to be selected; this process needs to assure an efficient way of determining the desired parameters from the measured data in a case when the measured data contain a high level of measuring uncertainty, i.e. noise. The results and contribution of national investigations of automatic interpretation of the data measured by geoelectric sounding, by direct and iterative process of soil approximation by a multilayer, as per [9] and [10], are important.

## 2 ARTIFICIAL NEURAL NETWORKS

If the measured data contain a high level of measuring uncertainty, the user needs to make decisions related to the ambiguity of the parameters. The user does this based on his own previous experience, i.e. acquired knowledge. This raises the question: Can the experience of a human being for such type of decision-making be replicated by means of artificial neural networks? The answer to this question is the subject of this paper. As suggested by the term itself, artificial neural network means a copy of the biological neural network present in the brain. The advantage of the artificial neural network over analytical models and classical algorithms is the learning capability it possesses, together with a capability of making decisions in case of ambiguity. A formal description of the artificial neuron was given as early as 1943 [11], but significant application started at the end of the last century in robotics and automatic sample recognition.

The most frequently used structure of neural networks is a multilayer neural network (MLP-*Multilayer Perceptrons*). Such a structure is made from the input neuron layer, one or more layers of hidden neurons and one output neuron layer. The structure of such a neural network [11] is shown in Figure 2.

**Slika 2**  
 Građa višeslojne  
 neuronske mreže  
**Figure 2**  
 Structure of the  
 multilayer neural  
 network

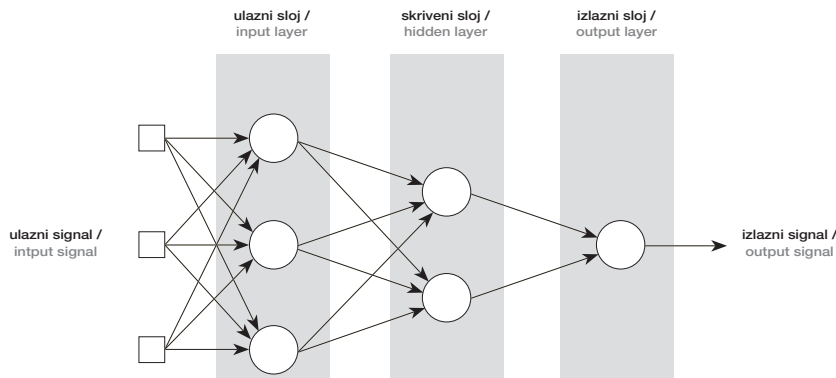

Broj neurona ulaznog sloja odgovara broju značajki koje opisuju problem, a broj neurona izlaznog sloja jednak je broju skupina za koje se provodi klasifikacija. Ulazni sloj neurona prenosi informaciju izlaznom sloju, u kojima se ulazne vrijednosti množe s pripadajućim težinama  $w_{kj}$  ( $k$  – redni broj sloja,  $j$  – redni broj težine) i nakon toga zbrajaju. Težine izlaznog sloja su promjenjivi parametri perceptronskih mreža i predmet su učenja. Učenje neuronske mreže provodi se skupom podataka za učenje, odnosno ulaznim i izlaznim vektorom, tj. unaprijed zadanim željenim ulaznim i izlaznim veličinama.

The number of neurons in the input layer is the same as the number of properties characterizing the problem, while the number of neurons in the output layer is the same as the number of groups for which classification is performed. The input neuron layer transfers the information to the output layer, where the input values are multiplied by the related weights  $w_{kj}$  ( $k$  – ordinal number of the layer,  $j$  – ordinal number of the weight) and then summarized. The weights of the outer layer are changeable parameters of the perceptron networks and they are a subject of learning. The learning of the neural network is performed by means of a training dataset, by an input and output vector, i.e. by means of the preset desired input and output values.

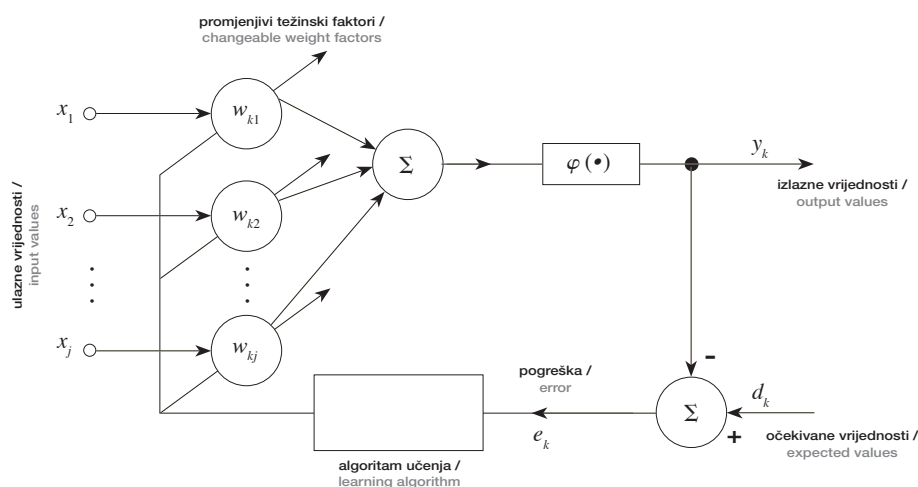

**Slika 3**  
 Tok podataka kroz  
 neuron  
**Figure 3**  
 Data flow through  
 the neuron

Različitim međusobnim povezivanjem neurona moguće je načiniti različite modele neuronskih mreža, s određenim prednostima i nedostacima (slika 3). Njihova svojstva određena su strukturom, karakterom aktivacijske funkcije

When the neurons are interconnected in different ways, different models of neural networks are obtained, and they have certain advantages and disadvantages (Figure 3). Their properties are determined by the structure, the nature of the

$\varphi(\bullet)$  i postupkom učenja [11]. U ovom radu primijenjen je postupak učenja neuronske mreže s nadzorom (engl. *supervised learning*). Inherentno paralelna struktura, kao i prilagodljiv način učenja neuronskih mreža omogućavaju uspostavljanje skrivenih zakonitosti i veza između ulaza i izlaza na težinske faktore. Na taj se način matematički veoma složena zadaća transformira u matematički model, koji se može s određenom vjerojatnošću riješiti. Kako u ulaznom skupu podataka uvijek postoji smetnja (šum), neuronska mreža i u tom slučaju ima sposobnost pronalaska najbližeg oblika ulaza, utemeljeno na prethodnom iskustvu izgrađenom učenjem. Iz tog razloga su neuronske mreže prikladne za rješavanje zadaća kod kojih je u ulaznom skupu podataka prisutna smetnja (šum). Nasuprot tome, rješavanje zadaća klasičnim tehnikama temeljenim na rješavanju sustava linearnih, odnosno nelinearnih jednadžbi, postaje upitno, upravo zbog prisutnosti smetnji. Navedeni razlozi dovoljni su motiv za pisanje ovog članka.

### 3 DVOSLOJNI MODEL TLA I WENNEROV RASPORED ELEKTRODA

Za većinu praktičnih primjena dvoslojni model tla s vertikalnom promjenom specifičnog električnog otpora se pokazao dostatnim [2]. Navedeni model tla podrazumijeva dva sloja tla: gornji i donji, koji se razlikuju u iznosu specifičnog električnog otpora. Pri tome je gornji sloj tla konačne debljine  $h$ , a donji se proteže u beskonačnost. Na osnovi navedenog takav model tla opisan je s tri značajke: specifični otpor gornjeg sloja  $\rho_g$ , njegova debljina  $h$ , te specifičnog otpora donjeg sloja  $\rho_d$ . Mjerenje specifičnog otpora tla Wennerovim rasporedom mjernih elektroda i model dvoslojnog tla s relevantnim veličinama prikazani su na slici 4.

activation function  $\varphi(\bullet)$  and by the learning procedure [11]. In this paper, supervised learning of the neural network has been applied. The inherently parallel structure, together with the adjustable way of learning of the neural networks, enable to establish the hidden laws and relationships between the output, input and the weight factors. In this way, a very complex mathematical task is transformed into a mathematical model that can be solved with a certain probability. The disturbance (noise) is always present in the input dataset, but even then the neural network has a capability of finding out the most similar input form, based on the previous experience acquired during learning. For this reason, neural networks are suitable for solving tasks where disturbance (noise) is present in the input dataset. In contrast to this, solving the tasks by means of conventional techniques based on solving the system of linear or non-linear equations is questionable, because of the presence of disturbances. These are the reasons for the composition of this paper.

### 3 DOUBLE-LAYER SOIL MODEL AND WENNER ELECTRODE CONFIGURATION

For the majority of practical applications, a double-layer soil model with a vertical change of the specific electrical resistivity has proven sufficient [2]. This soil model assumes two soil layers: an upper and lower layer, which have different specific electrical resistivity. The upper soil layer has a finite thickness  $h$ , whereas the lower layer is indefinitely thick. Based on the above, such a soil model is characterized by three properties: the specific resistivity of the upper layer  $\rho_g$ , its thickness  $h$ , and the specific resistivity of the lower layer  $\rho_d$ . The measurement of the specific soil resistivity by means of the Wenner measuring electrode configuration and the double-layer soil model are presented in Figure 4, with their relevant values.

**Slika 4**  
Dvoslojno tlo i Wennerov raspored elektroda  
Figure 4  
Double-layer soil and Wenner electrode configuration

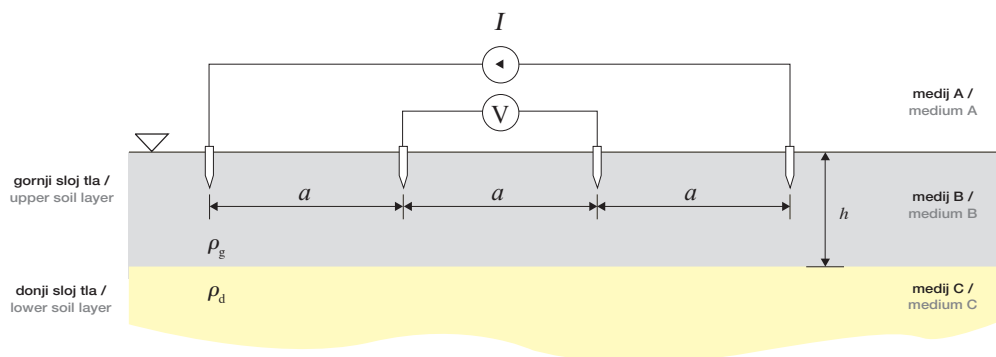

Utiskivanjem struje  $I$  kroz strujne elektrode u tlo, nastalo strujno polje u dvoslojnom tlu mora zadovoljiti rubne uvjete na granicama diskontinuiteta specifičnog električnog otpora tlo – zrak, te gornjeg i donjeg sloj tla, a koji glase [12], [13] i [14]:

By passing the current  $I$  through the current electrodes into the soil, the current field created in a double-layer soil must fulfil the boundary conditions on the discontinuity boundary of the specific electrical resistivity: soil – air, as well as at the upper and lower soil layer, which are as follows [12], [13] and [14]:

$$\mathbf{n} \times (\rho_A \mathbf{J}_A - \rho_B \mathbf{J}_B) = 0, \quad \mathbf{n} \times (\rho_B \mathbf{J}_B - \rho_C \mathbf{J}_C) = 0, \quad (1)$$

$$\mathbf{n} \cdot (\mathbf{J}_A - \mathbf{J}_B) = 0, \quad \mathbf{n} \cdot (\mathbf{J}_B - \mathbf{J}_C) = 0, \quad (2)$$

gdje je:

- $\mathbf{n}$  – vektor normale na granice diskontinuiteta specifičnog električnog otpora,
- $\mathbf{J}_A$  – gustoća struje u mediju A (zrak) na granici diskontinuiteta specifičnog električnog otpora,
- $\mathbf{J}_B$  – gustoća struje u mediju B (gornji sloj tla) na granici diskontinuiteta specifičnog električnog otpora i
- $\mathbf{J}_C$  – gustoća struje u mediju C (donji sloj tla) na granici diskontinuiteta specifičnog električnog otpora.

where:

- $\mathbf{n}$  – normal vector to the discontinuity boundaries of the specific electrical resistivity,
- $\mathbf{J}_A$  – current density in medium A (air) at the discontinuity boundary of specific electrical resistivity,
- $\mathbf{J}_B$  – current density in medium B (upper soil layer) at the discontinuity boundary of the specific electrical resistivity, and
- $\mathbf{J}_C$  – current density in medium C (lower soil layer) at the discontinuity boundary of the specific electrical resistivity.

Zrak (medij A) ima visok specifični električni otpor i smatra se da iznosi  $10^{18} \Omega\text{m}$ . Poznavanje rubnih uvjeta (1) i (2) na granicama diskontinuiteta specifičnog električnog otpora omogućava matematičko rješavanje zadaće i određivanje potencijala na naponskim mjernim elektrodama (slika 4). Navedena zadaća se najčešće rješava

Air (medium A) has a high specific electrical resistivity, it is considered to be  $10^{18} \Omega\text{m}$ . Having known the boundary conditions (1) and (2) at the discontinuity boundaries of the specific electrical resistivity enables the mathematical solution of the task and determination of the potential at the voltage measuring electrodes (Figure 4). This task



tehnikom odslikavanja izvora polja od granica diskontinuiteta specifičnog električnog otpora. Korištenjem tehnike odslikavanja izvora polja, tj. strujnih elektroda od granice tlo – zrak i granice između gornjeg i donjeg sloja tla, uz istodobno nadomještanje štapnih elektroda s prikladnim kuglastim, zadovoljavaju se jednadžbe rubnih uvjeta (1) i (2), a čiji je postupak pobliže opisan u [13] i [14].

Prvo odslikavanje odvija se na granici tlo – zrak, na kojoj se polukugla s kojom se nadomješta štapna elektroda odslikava u polukuglu u mediju A, kao što je to prikazano slikom 5. Slijedi odslikavanje dobivenih kugli A i D od granice gornjeg i donjeg sloja tla. Zatim se dobivena slika iz donjeg sloja tla odslikava od granice tlo – zrak, nakon čega se postupak ponavlja.

is usually solved by the method of images of the field sources from the discontinuity boundary of the specific electrical resistivity. Using the method of field source images, i.e. current electrodes from the boundary soil – air and boundary between the upper and lower soil layer, with simultaneous substitution of the pole electrodes by the suitable ball electrodes, the equations of boundary conditions are fulfilled: (1) and (2), the process is described in more detail in [13] and [14].

The first imaging is performed at the boundary soil – air, where the semi-ball which substituted the pole electrode is imaged into the semi-ball in medium A, as shown in Figure 5. Then, there is imaging of the obtained balls A and D from the boundary of the upper and lower soil layer. After that, the image obtained from the lower soil layer is imaged from the boundary soil – air, then the process is repeated.

**Slika 5**  
Odslikavanje u dvoslojnom tlu i Wennerov raspored elektroda  
**Figure 5**  
Imaging in the double-layer soil and Wenner electrode configuration

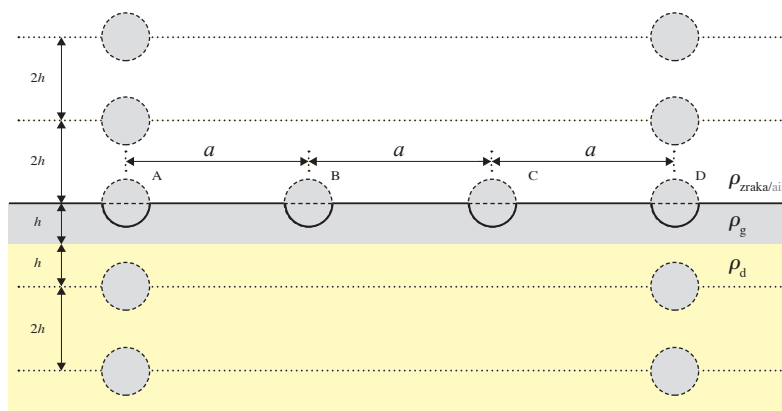

Potencijal u središtu naponske elektrode B zbog struja elektroda A i D iznosi:

The potential in the centre of the voltage electrode B due to the currents of the electrodes A and D is:

$$\varphi_B = (2I) \frac{\rho_g}{4\pi} \left( \frac{1}{a} - \frac{1}{2a} \right) = (2I) \frac{\rho_g}{4\pi} \left( \frac{1}{2a} \right). \quad (3)$$

Vrijednost struje je dvostruka (2I), jer se originalna polukugla iz koje istječe struja I stopila sa svojom slikom, koja je također polukugla, a iz koje istječe struja I. Potencijal u središtu naponske elektrode B, uz uvažavanje prva dva odslikavanja elektroda glasi:

The value of the current is double (2I), as the original semi-ball from which the current I runs out overlapped with its image which is also a semi-ball, from which the current I runs out. The potential in the centre of the voltage electrode B, taking into account the first two electrode images, is as follows:

$$\varphi_B = \frac{I\rho_g}{2\pi} \left[ \frac{1}{2a} + \left( \frac{2\beta}{\sqrt{a^2 + (2h)^2}} - \frac{2\beta}{\sqrt{(2a)^2 + (2h)^2}} \right) + \left( \frac{2\beta^2}{\sqrt{a^2 + (4h)^2}} - \frac{2\beta^2}{\sqrt{(2a)^2 + (4h)^2}} \right) \right]. \quad (4)$$

Kako je  $\varphi_B = -\varphi_C$ , zbog simetrije (slika 5) napon  $U_{BC}$  iznosi  $U_{BC} = 2\varphi_B$ , te se za omjer izmjerene napona  $U_{BC}$  i utisnute struje dobiva izraz:

As  $\varphi_B = -\varphi_C$ , for symmetry (Figure 5) the voltage  $U_{BC}$  is  $U_{BC} = 2\varphi_B$ , ratio between the measured voltage  $U_{BC}$  and imposed current is as per the expression:

$$\frac{U_{BC}}{I} = \frac{\rho_g}{\pi} \left[ \frac{1}{2a} + \left( \frac{2\beta}{\sqrt{a^2 + (2h)^2}} - \frac{2\beta}{\sqrt{(2a)^2 + (2h)^2}} \right) + \left( \frac{2\beta^2}{\sqrt{a^2 + (4h)^2}} - \frac{2\beta^2}{\sqrt{(2a)^2 + (4h)^2}} \right) \right]. \quad (5)$$

Prividni specifični otpor za Wennerov raspored elektroda glasi:

Apparent specific resistivity for Wenner electrode configuration is:

$$\rho_{PRIVIDNO/APARENT}(a) = 2\pi a \frac{U_{BC}}{I}. \quad (6)$$

Uvrštavanjem izraza (5) u izraz (6), dobiva se izraz za prividni specifični otpor tla, kada su uvažena prva dva odslikavanja, a koji glasi:

If (5) is introduced into (6), the expression for apparent specific soil resistivity is obtained, taking into account the first two images, as follows:

$$\rho_{PRIVIDNO/APARENT}(a) = \rho_g \left[ 1 + \left( \frac{4\beta}{\sqrt{1 + \left(\frac{2h}{a}\right)^2}} - \frac{4\beta}{\sqrt{4 + \left(\frac{2h}{a}\right)^2}} \right) + \left( \frac{4\beta^2}{\sqrt{1 + \left(\frac{4h}{a}\right)^2}} - \frac{4\beta^2}{\sqrt{4 + \left(\frac{4h}{a}\right)^2}} \right) \right]. \quad (7)$$

Kako su udaljenosti odslikanih izvora polja od granice tlo – zrak:  $2h, 4h, 6h, \dots$ , lako se određuje opći izraz za prividni specifični otpor tla za uvažanih  $N$  slika, a koji glasi:

As distances between the images of the field sources and the boundary soil – air are:  $2h, 4h, 6h, \dots$ , the general expression for apparent specific soil resistivity for the  $N$  images under consideration is easy to determine, as follows:

$$\rho_{PRIVIDNO/APARENT}(a) = \rho_g \left[ 1 + 4 \cdot \sum_{i=1}^N \beta^{(i)} \left( \left( 1 + \left( i \cdot \frac{2h}{a} \right)^2 \right)^{-\frac{1}{2}} - \left( 4 + \left( i \cdot \frac{2h}{a} \right)^2 \right)^{-\frac{1}{2}} \right) \right], \quad (8)$$

u kojemu se koeficijent refleksije  $\beta$  računa izrazom:

where the coefficient of reflection  $\beta$  is calculated by means of the expression:

$$\beta = \frac{\rho_d - \rho_g}{\rho_d + \rho_g}. \quad (9)$$

Primjenu izraza (8) najlakše je prikazati numeričkim primjerom.

The application of the equation (8) is best illustrated by a numerical example.

Neka je specifični električni otpor gornjeg sloja tla  $\rho_g = 300 \Omega\text{m}$  i debljine  $h = 1 \text{ m}$ , a specifični električni otpor donjeg sloja tla  $\rho_d = 100 \Omega\text{m}$ .

It is taken that specific electrical resistivity of the upper soil layer is  $\rho_g = 300 \Omega\text{m}$ , the thickness is  $h = 1 \text{ m}$  and the specific electrical resistivity of the lower soil layer is  $\rho_d = 100 \Omega\text{m}$ .

Tada se na osnovi izraza (8) dobiva krivulja prividnog specifičnog električnog otpora tla u funkciji razmaka između susjednih elektroda  $a$ , koja je prikazana na slici 6.

Based on the expression (8) the curve of the apparent specific soil resistivity as a function of the distance between two adjacent electrodes  $a$  is obtained; the curve is presented in Figure 6.

### Slika 6

Prividni specifični otpor dvoslojnog tla u funkciji udaljenosti između dvije susjedne elektrode

### Figure 6

Apparent specific resistivity of the double-layer soil as a function of distance between two adjacent electrodes

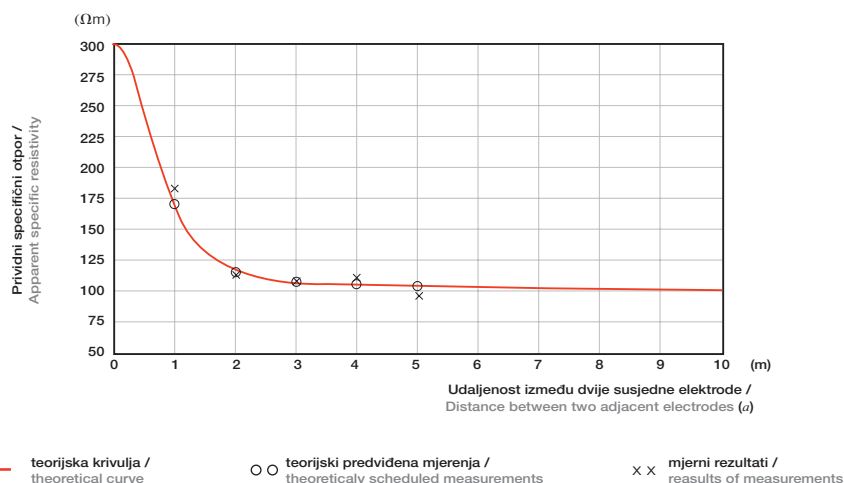

Za male razmaka između elektroda struja utisnuta u tlo većim dijelom se zatvara kroz gornji sloj tla, te je iz tog razloga prividni specifični otpor jednak gornjem sloju tla. Povećanjem razmaka između strujnih elektroda struja dublje prodire u tlo, te se silnice zatvaraju i preko donjeg sloja tla. U slučaju velikog razmaka između strujnih elektroda, silnice strujnog polja veći dio puta prolaze kroz donji sloj tla, te je u tom slučaju prividni specifični električni otpor jednak specifičnom električnom otporu donjeg sloja tla.

Iako se na temelju jednadžbi (8) i (9) s visokom točnošću dobiva kontinuirana krivulja prividnog specifičnog otpora pri praktičnim mjerenjima prividni specifični otpor poznat je samo u diskretnom skupu razmaka elektroda npr.  $a = 1, 2, 3, 4$  i  $5$  m. Naime elektrode se ne smiju približavati na udaljenost koja je manja od duljine elektrode u tlu, jer je tada utjecaj elektrode na elektrodu velik. Iz tog razloga na temelju mjernih rezultata nije moguće odrediti na jednostavni način specifični električni otpor gornjeg sloja tla. Ukoliko je to potrebno, tj. ukoliko se očekuje da je gornji sloj tla tanak, tada mjerenje treba provesti s manjim razmakom između elektroda (npr.  $a = 0,75$  m,  $1$  m,  $1,5$  m, ...). Pri određivanju prividnog specifičnog otpora u tom slučaju treba koristiti točniji izraz od (8). Ujedno izbjegava se i veliki razmak između elektroda, tako da se teško određuje i specifični električni otpor donjeg sloja tla.

Osvrtom na sliku 6 odmah postaje jasno da će u takvim prilikama biti teško odrediti specifični otpor slojeva tla i debljinu gornjeg sloja tla. Teorijski predviđen skup mjernih podataka predstavlja uzorke iz teorijski dobivene kontinuirane krivulje prividnog specifičnog otpora i na slici 6 prikazani su kružićima. Stvarni rezultati mjerenja u sebi

In the case of small distances between the electrodes, the current passed into the soil mostly flows in the upper soil layer, therefore the apparent specific electrical resistivity is equal to the specific electrical resistivity of the upper soil layer. If the distance between the current electrodes is increased, the current penetrates deeper into the soil, and the field lines pass through the lower soil layer too. If the distance between the current electrodes is great, the current field lines for most of their journey pass through the lower soil layer, and in that case the apparent specific electrical resistivity is equal to the specific electrical resistivity of the lower soil layer.

Although, based on the equations (8) and (9), the continuous curve of the apparent specific resistivity is obtained with a high level of accuracy, the apparent specific resistivity in practical measuring is known only for a discrete set of the electrode distances, i.e.  $a = 1, 2, 3, 4$  and  $5$  m. That is to say, the distance between the electrodes must not be smaller than length of the electrode in the soil, for then one electrode would have a strong influence on another. For this reason, there is no simple way for determining the specific electrical resistivity of the upper soil layer from the results of measurement. If this is necessary, i.e. if a thin upper layer is expected, the measuring must be performed with a smaller distance between the electrodes (e.g.  $a = 0,75$  m,  $1$  m,  $1,5$  m, ...). When the apparent specific resistivity is determined in such the case, a more accurate expression than (8) must be used. A large distance between the electrodes is avoided, and therefore it is difficult to determine the specific electrical resistivity of the lower soil layer.

The Figure 6 shows that in such cases it is difficult to determine the specific resistivity of the soil layers and thickness of the upper soil layer. The

sadrže mjernu nesigurnost odnosno smetnju te s tog razloga odstupaju od teorijski predviđenog skupa mjernih podataka i na slici 6 prikazani su križićima.

## 4 NADOMJESNI MODEL TLA ZASNOVAN NA UMJETNIM NEURONSKIM MREŽAMA

Matematički je dokazano da neuronske mreže mogu uniformno približiti, uz željenu točnost, bilo koju kontinuiranu funkciju  $f: D_f \subset R^n \rightarrow R^m$  funkcijom  $g$  nad  $D_f$ , gdje je  $D_f$  podskup od  $R^n$  pod uvjetom da imaju dovoljan broj neurona [11], odnosno njihovih težina. Pri tome se kod funkcije cilja uobičajeno zahtijeva da suma kvadratnih odstupanja bude minimalna, odnosno funkcija cilja u tom slučaju glasi:

$$E = \frac{1}{N} \sum_{n=1}^N (d_n - y_n)^2. \quad (10)$$

Navedena funkcija predstavlja mjeru odstupanja izlaza neuronske mreže  $y_n$  od željenih vrijednosti  $d_n$ . U prethodnom izrazu s  $N$  je označen broj elemenata u skupu podataka za učenje.

U ovom radu aproksimacija se odnosi na funkciju zadanu jednačbom (8). Dvoslojno tlo opisano je s tri značajke, odnosno kada se govori o izlazu iz neuronske mreže s tri parametra. Dva su parametra specifični električni otpori gornjeg i donjeg sloja tla, a jedan je debljina gornjeg sloja tla. Zadaća koja se postavlja nad neuronskom mrežom je prepoznavanje parametara, odnosno značajki tla na temelju mjernih podataka dobivenih Wennerovom tehnikom mjerenja specifičnog električnog otpora. Kako se na izlazu iz neuronske mreže dobivaju tri parametara, na ulazu je potrebno imati barem tri parametra, odnosno mjerna rezultata. Za kvalitetnije rasuđivanje neuronske mreže poželjniji je veći broj mjernih podataka, koji je ograničen raspoloživim vremenom za mjerenje. U članku je proizvoljno uzeta vrijednost od pet mjerenja po uzorku tla. Veći broj dostupnih mjerenja je povoljniji slučaj te iz tog razloga nije razmatran.

Ulazni skup podataka za učenje neuronske mreže dobiven je korištenjem teorijskog modela dvoslojnog tla, iskazan prividnim specifičnim

theoretically scheduled set of measured data represents the samples from the theoretically obtained continuous curve of the apparent specific resistivity, and they are marked with circles in Figure 6. The actual results of measurement include a measuring uncertainty, i.e. disturbance, and therefore there is a deviation from the theoretically scheduled set of measured data, in Figure 6 they are marked with crosses.

## 4 SUBSTITUTION SOIL MODEL BASED ON ARTIFICIAL NEURAL NETWORKS

It has been mathematically proven that neural networks can uniformly approximate, with the desired accuracy, any continuous function  $f: D_f \subset R^n \rightarrow R^m$  by a function  $g$  over  $D_f$ , where  $D_f$  is a subset of  $R^n$  under the condition that there are enough neurons available [11], i.e. their weights. For the goal function, it is usually necessary to minimize the sum of square deviations, i.e. the goal function in that case is as follows:

This function represents a level of deviation of the neural network output  $y_n$  from the desired values  $d_n$ . In the preceding expression,  $N$  refers to the number of elements in the learning dataset.

In this paper, the approximation refers to the function given by the equation (8). The double-layer soil is characterized by three properties, i.e. when the neural network output is considered, by three parameters. Two of the parameters are the specific electrical resistivities of the upper and lower soil layer, the third parameter is the thickness of the upper soil layer. The task assigned to the neural network is the recognition of parameters, i.e. of the soil properties based on the measured data obtained by the Wenner technique for measuring specific electrical resistivity. As the three parameters are obtained at the neural network output, at least three parameters, i.e. results of measurement, are required at the input. In order to obtain better reasoning in the neural network, it is desirable to have more results of measurement; the number of data is limited by the time available for measuring. In the paper, five measurements per soil sample have been assumed. The availability of a greater number of measurement results would be a favourable situation, and therefore it has not been taken into consideration.

otporom u funkciji razmaka između susjednih mjernih elektroda pri Wennerovom rasporedu elektroda. Izlazni odnosno željeni skup podataka  $d = (\rho_g, h, \rho_d)$  za učenje neuronske mreže su vrijednosti parametara na kojima je dobiven ulazni skup podataka  $x_k = \rho_{\text{PRIVIDNO}}(k)$ ,  $k = 1, 2, 3, \dots, 5$  (slika 3).

Ovisno o geografskom položaju i lokalnom karakteru tla, te sezonskim promjenama, gornji sloj tla može imati veći ili manji specifični električni otpor od donjeg sloja tla. U ovom članku razmatranja su ograničena na poseban slučaj kada su promjene specifičnog električnog otpora gornjeg i donjeg sloja tla od 50  $\Omega\text{m}$  do 250  $\Omega\text{m}$ , uz pretpostavku da se debljina gornjeg sloja tla kreće u rasponu od 0,125 m do 1,25 m. Navedene promjene specifičnog električnog otpora tipične su za Slavoniju. Na taj način je učenje neuronske mreže pojednostavljeno zbog manjeg broja mogućih slučajeva koji mogu nastupiti, a da se općenitost razmišljanja nije izgubila.

Ulazni skup podataka za učenje neuronske mreže dobiven je diskretizacijom jednadžbe (8). U tu svrhu za diskretne vrijednosti specifičnog električnog otpora gornjeg i donjeg sloja tla, kao i debljine gornjeg sloja tla mijenjana je udaljenost  $a$  (slika 4) između dvije susjedne elektrode. Vrijednosti dobivenog prividnog specifičnog otpora dovedene su na ulaz neuronske mreže. Vrijednosti specifičnog električnog otpora gornjeg i donjeg sloja tla, kao i debljina gornjeg sloja dovedeni su na izlaz neuronske mreže, te je izvršeno njezino učenje. Postupak se ponavlja uzastopno, pri čemu se mijenja vrijednost specifičnog električnog otpora gornjeg i donjeg sloja tla, te debljina gornjeg sloja tla. Ulazni i izlazni skup podataka, uz pomoć kojih je učena umjetna neuronska mreža, sažet je u tablici 1.

The input dataset for the learning of the neural network has been obtained by means of a theoretical model of the double-layer soil, expressed by apparent specific resistivity as a function of distance between two adjacent measuring electrodes in the Wenner electrode configuration. The output dataset, i.e. the desired data  $d = (\rho_g, h, \rho_d)$  for the learning of the neural network are the parameter values used for obtaining the input dataset  $x_k = \rho_{\text{APPARENT}}(k)$ ,  $k = 1, 2, 3, \dots, 5$  (Figure 3).

Depending on geographical position and on the local character of the soil, as well as on seasonal variations, the specific electrical resistivity of the upper soil layer can be higher or lower than the specific electrical resistivity of the lower soil layer. In this paper, the considerations are limited to a specific case when variations of the specific electrical resistivity of the upper and lower soil layer range from 50  $\Omega\text{m}$  to 250  $\Omega\text{m}$ , with an assumption that the thickness of the upper soil layer ranges from 0,125 m to 1,25 m. These changes of the specific electrical resistivity are typical for Slavonia. In this case, the neural network learning is simplified as there are fewer possible cases that may occur, whereas the generality of the reasoning has not been lost.

The input dataset for the learning of the neural network has been obtained by discretization of the equation (8). For that purpose, at discrete values of specific electrical resistivity of the upper and lower soil layer, as well as of the upper soil layer thickness, the distance  $a$  (Figure 4) between the two adjacent electrodes has been altered. The apparent specific resistivities obtained are taken to the neural network input. Values of specific electrical resistivity of the upper and lower soil layer, as well as the thickness of the upper soil layer, are taken to the neural network output and learning is performed. The procedure is successively repeated, whereupon the values of specific electrical resistivity of the upper and lower soil layer and the thickness of the upper soil layer are altered. The input and output datasets that were used for the learning of the neural network are summarized in Table 1.

Tablica 1 – Ulazno-izlazni skup podataka korišten za učenje neuronske mreže  
Table 1 – The input-output dataset used for learning of the neural network

	Debljina gornjeg sloja / Thickness of the upper soil layer $h$ (m)	Specifični otpor gornjeg sloja tla / Specific resistivity of the upper soil layer $\rho_g$ ( $\Omega\text{m}$ )	Specifični otpor donjeg sloja tla / Specific resistivity of the lower soil layer $\rho_g$ ( $\Omega\text{m}$ )
Referentna veličina / Reference value	od 0,125 do 1,25 u koracima po 0,125 / from 0,125 to 1,25 in increments of 0,125	od 50 do 250 u koracima po 50 / from 50 to 250 in increments of 50	od 50 do 250 u koracima po 50 / from 50 to 250 in increments of 50
Varijabla / Variable	$h_k$ $k=1,2,3,\dots,10$	$\rho_{g,j}$ $j=1,2,3,\dots,5$	$\rho_{d,z}$ $z=1,2,3,\dots,5$
Ulazna veličina / Input value	$\rho_{\text{PRIVIDNO/APARENT}}(a) = \rho_{g,j} \left[ 1 + 4 \cdot \sum_{i=1}^{10} \left( \frac{\rho_{d,z} - \rho_{g,j}}{\rho_{d,z} + \rho_{g,j}} \right)^{(i)} \left( \left( 1 + \left( i \cdot \frac{2h_k}{a} \right)^2 \right)^{-\frac{1}{2}} - \left( 4 + \left( i \cdot \frac{2h_k}{a} \right)^2 \right)^{-\frac{1}{2}} \right) \right]$ $a=1,2,3,4,5$		

Nakon završetka postupka učenja neuronske mreže provjereno je stečeno znanje i sposobnost neuronske mreže pri donošenju suvislih odluka u slučajevima kada skup ulaznih podataka sadrži šum koji izaziva slučajne promjene amplitude do  $\pm 5\%$ . U ovom članku korištena je gotova neuronska mreža kompanije Alyuda, pod nazivom Forecaster XL. Navedeno softversko rješenje integrira se u Microsoftov program Excel, te je na taj način olakšana manipulacija ulaznim i izlaznim podacima, a za grafički prikaz koristi se grafičko sučelje programa Excel.

Više informacija o navedenom softveru može se naći na stanicama proizvođača: <http://www.alyuda.com>. O ostalim softverskim rješenjima neuronskih mreža zainteresirani čitatelj može pronaći na web stranicama: <http://www.neuroshell.com>, <http://www.palisade-europe.com>. Priprema ulaznih podataka izvršena je matematičkim paketom opće namjene Mathcad 2000, a proizvod je tvrtke: MathSoft Inc. ([www.mathsoft.com](http://www.mathsoft.com)).

## 5 NUMERIČKI REZULTATI

Uspješnost rasuđivanja umjetne neuronske mreže na nove ulazne mjerne podatke, koji sadrže uniformno distribuirani šum do  $\pm 5\%$  iznosa amplitude iskazana je postotnom pogreškom u određivanju parametara dvoslojnog modela tla. Pogreške koje donosi neuronska mreža u određivanju parametara dvoslojnog tla prikazane su na slikama 7, 8 i 9. Na slikama 7, 8 i 9 krivulje pogreške određivanja parametara dvoslojnog tla odnose se na skupove podataka koji sadrže jednak

After completion of the learning procedure of the neural network, the acquired knowledge of the neural network and its capability of making the relevant decisions in cases when the input dataset contains noise that causes accidental changes of amplitude up to  $\pm 5\%$  were tested. In this paper, a neural network of the company Alyuda, known under the name Forecaster XL, has been used. This software concept has been integrated in the Microsoft Excel, which makes manipulation by input and output data easier, whereas the Excel graphic interface has been used for graphic presentation.

More information about this software is available on the manufacturer's web site: <http://www.alyuda.com>. Various software solutions for neural networks are available on web sites: <http://www.neuroshell.com>, <http://www.palisade-europe.com>. The input data have been processed by a general purpose mathematical package Mathcad 2000, by MathSoft Inc. ([www.mathsoft.com](http://www.mathsoft.com)).

## 5 NUMERICAL RESULTS

The reasoning of the artificial neural network using the new input measured data that contain uniformly distributed noise up to  $\pm 5\%$  of the amplitude value is expressed by a percentage error in determining the parameters of the double-layer soil model. The errors caused by the neural network in determining the parameters of the double-layer soil are presented in Figures 7, 8 and 9. The curves of the error in determining the parameters of the double-layer soil, Figures 7, 8 and 9, refer to the datasets that contain the same number of elements as the dataset that has been used for the learning

broj elemenata kao i skup podataka s kojim je učena neuronska mreža. Skup podataka s kojim je ispitano stečeno znanje neuronske mreže sadrži u sebi smetnju uniformno distribuiranog šuma do  $\pm 5$  % iznosa svakog pojedinog elementa u ispitnom skupu.

Kako je odziv neuronske mreže na ispitni skup podataka koji sadrži stohastičku smetnju također stohastički, potrebno je ponoviti ispitivanje s većim brojem istovrsnih ispitnih skupova. Ispitivanje s istovrsnim skupovima podataka treba ponavljati sve dok se na temelju izračunatog prosjeka ne dobije glatka krivulja odziva. Kako je u promatranom slučaju odziv u vidu pogreške, na jedan ispitni skup podataka koji sadrži šum davao relativno glatku krivulju, bez ekstrema, dovoljno je bilo ponoviti ispitivanje još samo četiri puta. Nakon pet uzastopno ponovljenih ispitivanja odziva neuronske mreže ispitnim podacima koji sadrže smetnju dobivena je krivulja prosjeka odziva iskazana u vidu pogreške i prikazana je crvenom bojom na slikama 7, 8 i 9.

Na slici 7 prikazane su krivulje postotnih pogreški neuronske mreže pri procjeni debljine gornjeg sloja dvoslojnog tla u funkciji debljine gornjeg sloja tla.

of the neural network. The dataset that has been used for testing the acquired knowledge of the neural network contains disturbance with uniformly distributed noise up to  $\pm 5$  % of the value of each element in the testing dataset.

As the neural network response to the testing dataset containing stochastic disturbance is also stochastic, the testing needs to be repeated with more testing datasets of the same type. Testing with datasets of the same type must be repeated until a smooth response curve is obtained based on the calculated average value. Since in the case monitored the response in an error form, per set of test data containing the noise, provided quite a smooth curve, with no extreme points, it was satisfactory to repeat this testing four times only. After five successively repeated tests of the neural network response to the test data containing disturbance, a curve of average response values has been obtained, expressed as an error and shown by the red colour in Figures 7, 8 and 9.

In Figure 7 the curves of percentage errors of the neural network in assessment of thickness of the upper soil layer are presented as a function of the thickness of the upper soil layer.

**Slika 7**  
Postotna pogreška određivanja debljine gornjeg sloja tla  
**Figure 7**  
Percentage error in determining of thickness of the upper soil layer

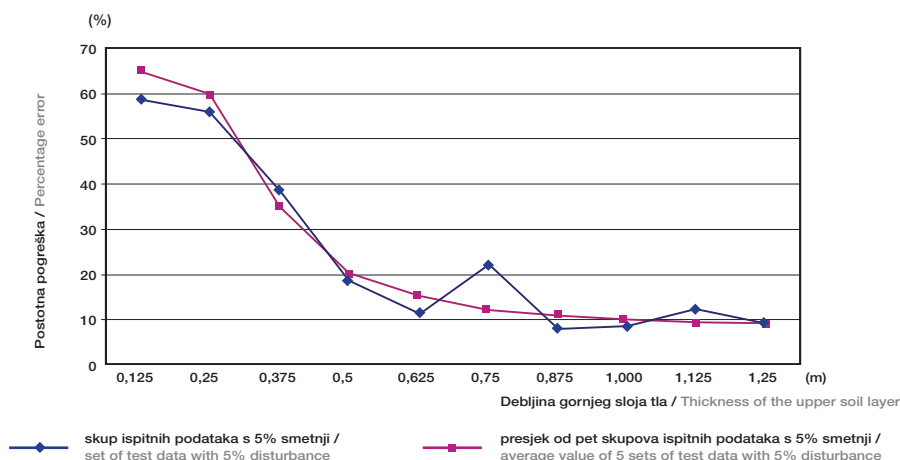

Na slici 8 prikazane su krivulje postotnih pogreški neuronske mreže pri procjeni specifičnog električnog otpora gornjeg sloja dvoslojnog tla u funkciji debljine gornjeg sloja tla.

Figure 8 shows the curves of percentage errors of the neural network in assessment of the specific electrical resistivity of the upper layer in double-layer soil as a function of the thickness of the upper soil layer.

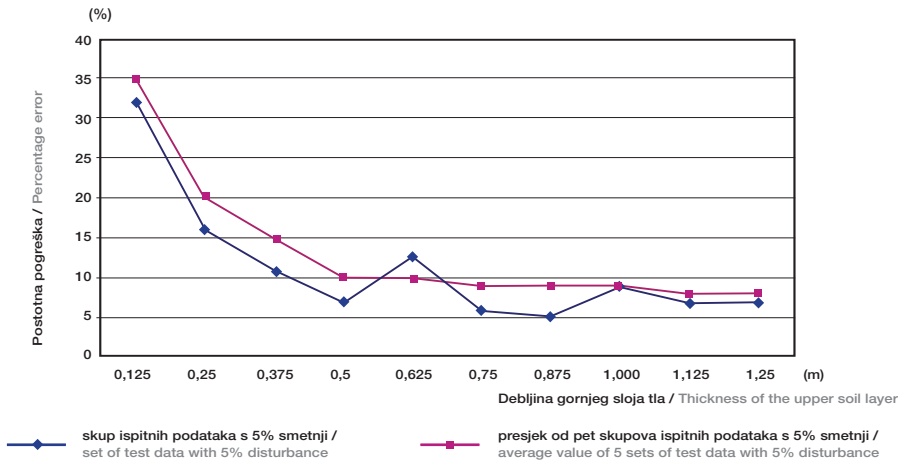

**Slika 8**  
Postotna pogreška određivanja specifičnog električnog otpora gornjeg sloja tla  
**Figure 8**  
Percentage error in determining the specific electrical resistivity of the upper soil layer

Na slici 9 prikazane su krivulje postotnih pogreški neuronske mreže pri procjeni specifičnog električnog otpora donjeg sloja dvoslojnog tla u funkciji debljine gornjeg sloja tla.

Figure 9 shows the curves of percentage errors of the neural network in assessment of the specific electrical resistivity of the lower layer of double-layer soil as a function of the thickness of the upper soil layer.

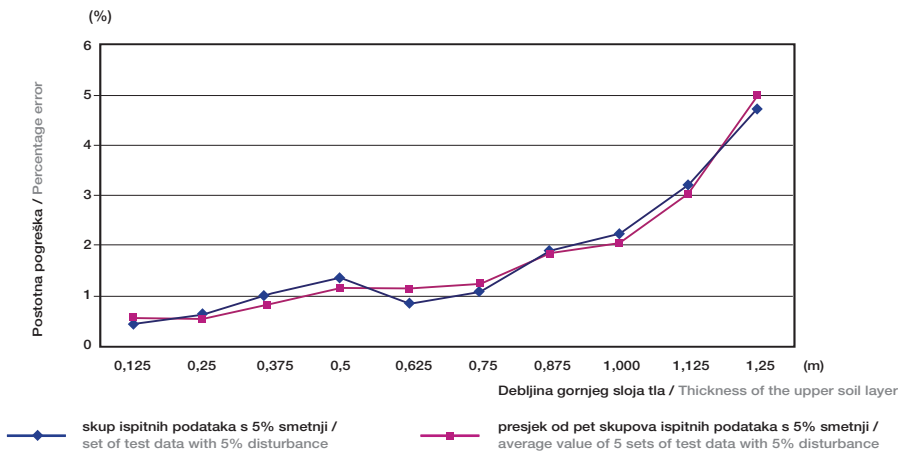

**Slika 9**  
Postotna pogreška određivanja specifičnog električnog otpora donjeg sloja tla  
**Figure 9**  
Percentage error in determining the specific electrical resistivity of the lower soil layer

## 6 ANALIZA REZULTATA

Kratki osvrt na krivulje postotnih pogrešaka odziva neuronske mreže pri procjeni parametara tla u odnosu na točne vrijednosti ukazuju na vrlo dobro rasuđivanje neuronske mreže. Usporedbom krivulja pogrešaka na slikama 7, 8 i 9 lako je zaključiti da neuronska mreža najbolje procjenjuje specifični električni otpor donjeg sloja tla (slika 9).

Krivulja postotne pogreške u procjenjivanju specifičnog električnog otpora donjeg sloja tla je monotono rastuća sa smjernicom porasta debljine gornjeg sloja tla. Rezultat je očekivan, jer se

## 6 ANALYSIS OF RESULTS

A short review of the curves presenting the percentage errors of the neural network response in assessment of the soil parameters in comparison with actual values indicates very good reasoning on the part of the neural network. Comparison of the error curves presented in Figures 7, 8 and 9 shows that the neural network performs best in assessing the specific electrical resistivity of the lower soil layer (Figure 9).

The percentage error curve in assessing the specific electrical resistivity of the lower soil layer increases



porastom debljine gornjeg sloja tla povećava i duljina puta kojeg silnice strujnog polja prolaze kroz gornji sloj tla, te na taj način raste i utjecaj gornjeg sloja tla na prividni specifični električni otpor, a time i na pogrešku.

Prilikom procjene parametara, odnosno značajki gornjeg sloja tla, krivulje postotnih pogreški su monotono padajuće s obzirom na porast debljine gornjeg sloja tla. I ovaj rezultat je očekivan. Naime, porastom debljine gornjeg sloja tla raste i duljina puta kojeg silnice strujnog polja prelaze u gornjem sloju tla, te na taj način prividni specifični otpor tla sadrži sve veću informaciju o gornjem sloju tla. Kao rezultat navedenog porast debljine gornjeg sloja tla ima blagodatno utjecaj na rasuđivanje neuronske mreže, odnosno pogreška se smanjuje.

Postoji nekoliko postupaka uz pomoć kojih bi se moglo poboljšati rasuđivanje neuronske mreže pri procjeni parametara gornjeg sloja tla, kada je on tanak. Neuronsku mrežu bi trebalo učiti s većim skupom ulaznih podataka, odnosno koraci promjene debljine gornjeg sloja tla bi trebali biti manji. Učinkovitiji postupak bi bio da se veći broj diskretnih vrijednosti razmaka elektroda  $a$  odnosi na manje razmake (npr.  $a = 0,75$  m, 1 m, 1,5 m, ...). Pri povećanju broja ulaznih podataka s kojima se uči neuronska mreža treba imati na umu da odstupanje (disperzija) odziva neuronske mreže načelno prati zakonitost:  $\sigma \propto 1/\sqrt{N}$ , gdje je  $N$  broj ulaznih podataka. Iz tog razloga dvostruko povećanje broja ulaznih podatka smanjit će disperziju odziva za faktor  $1/\sqrt{2}=0,7$ , četverostruko povećanje za faktor  $1/\sqrt{4} = 0,5$  itd. Iz tog razloga pri povećanju broja podataka s kojima se uči neuronska mreža treba biti odmjeren.

## 7 ZAKLJUČAK

Na temelju dobivenih rezultata i njihove analize, neosporno je i razvidno da se neuronske mreže mogu uspješno koristiti za procjenu parametara dvoslojnog tla. Ovaj članak dao je potvrđan odgovor na pitanje: Može li se iskustvo čovjeka za takvu vrstu odlučivanja replicirati korištenjem umjetnih neuronskih mreža? Autori smatraju da će se primjena neuronskih mreža u energetici i dalje povećavati. Za takvo razmišljanje postoji više argumenata.

Predviđanja rasta procesorske snage i dalje prate Mooreov zakon, prema kojemu se procesorska snaga udvostručuje svakih 18 do 24 mjeseci, što daje hardversku osnovu za složenije, a time i moćnije neuronske mreže. Dinamika rada uvjetuje veću produktivnost djelatnika, koja se

uniformly, while the thickness of the upper soil layer tends to increase. This result is expected, as the increase of thickness of the upper soil layer affects the increase of the journey length of the current field lines through the upper soil layer. Therefore, the influence of the upper soil layer on the apparent specific electrical resistivity and on the error increases.

In assessment of the parameters, i.e. the properties of the upper soil layer, the percentage error curves decrease uniformly with regard to the increase of thickness of the upper soil layer. This result is also expected. The increase of thickness of the upper soil layer affects the increase of the journey length of the current field lines through the upper soil layer, therefore the apparent specific soil resistivity is getting more and more information about the upper soil layer. As a result of the above-mentioned, the increase of thickness of the upper soil layer has a beneficial influence on the neural network's reasoning, i.e. the error decreases.

There are several processes that might improve the neural network's reasoning in assessment of parameters of the upper soil layer when it is thin. The neural network needs to learn using a bigger dataset, i.e. change increments of the upper soil layer thickness need to be smaller. If the majority of discrete values of the electrode distances  $a$  refer to smaller distances (e.g.  $a = 0,75$  m, 1 m, 1,5 m, ...), the process is more effective. If the number of input data used for the learning of the neural network increases, it needs to be taken into consideration that deviation (dispersion) of the neural network response basically follows the rule:  $\sigma \propto 1/\sqrt{N}$ , where  $N$  is the number of input data. For this reason, redoubling the number of input data decreases the response dispersion by the factor  $1/\sqrt{2}=0,7$ , at fourfold decreases by the factor  $1/\sqrt{4} = 0,5$  etc. Therefore, the increase of the number of data used for the learning of the neural network needs to be reasonable.

## 7 CONCLUSION

Based on the obtained results and their analysis, it is evident that neural networks can be successfully used for assessment of the parameters of double-layer soil. This paper gives an affirmative answer to the question: Can human experience for such the type of decision-making be replicated by means of artificial neural networks? The authors hold that application of neural networks in energetics will continue to increase. There are number of reasons for such a standpoint.

može povećati jedino pomoćnim sredstvima, kao što su prikladni programski alati, koji ne iziskuju posebne zahtjeve za školovanjem, a time i financijskim sredstvima. Programski alati temeljeni na neuronskim mrežama udovoljavaju takvim zahtjevima. Primjena neuronskih mreža izuzetno je učinkovita kod složenijih sustava, a kojima obiluje energetika. Minimiziranje gubitaka proizvodnje i prijenosa električne energije, pomoć dispečerima u donošenju odluka, predviđanje potrošnje na temelju prethodnih razdoblja, samo su neki od primjera u kojima se mogu primijeniti neuronske mreže.

The increase of processor capacity continues to follow the Moore law that says that processor capacity is doubled every 18 to 24 months, which provides a hardware basis for neural networks of higher complexity, i.e. higher power. Due to work dynamics, a higher productivity of employees is required, and this increase can be realized by auxiliary means only, e.g. by suitable software tools that do not require any special training i.e. financial resources. The software tools based on neural networks meet such requirements. Application of neural networks is very efficient in complex systems, which are widespread in energetics. Minimizing the losses in production and transmission of electrical power, assistance to dispatchers in making decisions, forecasting of consumption based on previous time periods – these are a few examples which demonstrate the possibilities for application of neural networks.

---

## LITERATURA / REFERENCES

- [1] MAJDANDŽIĆ, F., Uzemljivači i sustavi uzemljenja, Graphis, Zagreb, 2004.
- [2] IEEE Std. 81-1983, IEEE Guide for Measuring Earth Resistivity, Ground Impedance and Earth Surface Potentials of a Ground System, (Revision of IEEE Std. 81-1962), The Institute of Electrical and Electronic Engineers, New York, 1983
- [3] HADDAD, A., WARNE, D. F., Advanced High Voltage Engineering, The Institution of Electrical Engineers, London, 2004
- [4] IEEE Std. 80 - 2000, IEEE Guide for Safety in AC Substation Grounding, The Institute of Electrical and Electronic Engineers, New York, 2000
- [5] TAGG G. F., Earth Resistances, G. Newnes Ltd., England, 1964, 1<sup>st</sup> ed.
- [6] Engineering Recommendation S.34-a: Guide for Assessing The Rise Of Earth Potential at Substation Sites, The Electricity Association, London, 1986
- [7] WENNER, F., A Method for Measuring Earth Resistivity, Bureau of Standards scientific paper, no. 258, Washington D.C., 1915
- [8] VAN NOSTRAND, R. G., COOK, K. L., Interpretation of Resistivity Data, Geological Survey professional paper 499, US Dept. Of the Interior, Washington D.C., 1966
- [9] VUJEVIĆ, S. , KURTOVIĆ, M. , Direct and Iterative Automatic Interpretation of Resistivity Sounding Data, ENGINEERING MODELLING 5(1992), No. 3-4, Split, 1992.
- [10] VUJEVIĆ, S. , KURTOVIĆ, M. , Efficient Use of Exponential Approximation of the Kernel Function in Interpretation of Resistivity Sounding Data, ENGINEERING MODELLING, 5(1992), No. 1-2, Split, 1992.
- [11] NOVAKOVIĆ, B., MAJETIĆ, D., ŠIROKI, M., Umjetne neuronske mreže, X-Press, Zagreb, 1998.
- [12] SENIOR, T.B.A., VOLAKIS, J. L., Approximate Boundary Conditions in Electromagnetics, The Institution of Electrical Engineers, London, 1995
- [13] HAZNADAR, Z., ŠTIH, Ž., Elektromagnetizam 1, Školska knjiga, Zagreb, 1997.
- [14] HAZNADAR, Z., ŠTIH, Ž., Electromagnetic Fields, Waves and Numerical Methods, IOS Press, Ohmsha, Amsterdam, Volume 20, 2000

---

Uredništvo primilo rukopis:  
2006-11-15

Manuscript received on:  
2006-11-15

Prihvaćeno:  
2007-01-04

Accepted on:  
2007-01-04