

# CUTTING TOOL WEAR MONITORING WITH THE USE OF IMPEDANCE LAYERS

*Marek Sadílek, Jiří Kratochvíl, Jana Petřů, Robert Čep, Tomáš Zlámal, Dana Stančková*

Preliminary notes

The article deals with problems of cutting process monitoring in real time. It is focused on tool wear by means of impedance layers applied on ceramic cutting inserts. In the experimental part the cutting process is monitored using electrical resistance measurement. The results are compared and verified using the monitored cutting temperature and tool wear. The testing of impedance layers is reasonable mainly for cutting edge diagnostics. The width of this layer determines the wear allowance of tool wear (flank wear). Excessive wear causes a sharp reduction of this layer and thus a sharp increase in electrical resistance, which is a warning signal of the end of the cutting edge durability.

**Keywords:** *ceramic insert, impedance layer, tool wear, turning*

## Nadzor trošenja reznog alata upotrebom otpornih slojeva

Prethodno priopćenje

Članak se bavi problemima nadzora procesa rezanja u stvarnom vremenu. Usmjeren je na trošenje alata pomoću otpornih slojeva primjenjenih na keramičkim pločicama. U eksperimentalnom dijelu postupak rezanja se prati pomoću mjerenja električnog otpora. Rezultati su uspoređeni i verificirani pomoću mjerenja temperature rezanja i trošenja alata. Ispitivanje impedancijskih slojeva je prihvatljivo uglavnom za dijagnostiku rezne oštrice. Širina tog sloja određuje dodatak zbog trošenja (trošenje stražnje površine). Pretjerano trošenje uzrokuje značajno smanjenje tog sloja, a time i značajan porast električnog otpora, što je znak upozorenja na kraj trajnosti rezne oštrice.

**Ključne riječi:** *keramička pločica, otporni sloj, trošenje alata, tokarenje*

## 1 Introduction

One of the current priorities is the reduction of production costs. One of the many solutions to this problem is to use 100 % of the cutting tool, that is, its entire tool life, while respecting the requirements for surface quality.

Several methods have been proposed to monitor tool wear. There are two main categories: direct methods and indirect methods.

Direct methods, such as machine vision systems, use a charged-couple-device (CCD) camera or optical microscope [1]. Direct methods have the advantage of capturing actual geometric changes arising from the wear of the tool. However, direct measurements are very difficult to obtain due to the continuous contact between the tool and the workpiece, and are made almost impossible by the presence of coolant fluids [2]. These difficulties severely limit the application of a direct approach [3].

Indirect methods correlate or match appropriate sensor signals to tool wear states. The advantages are a less complicated setup and greater suitability to practical application. In indirect methods, tool condition is not captured directly, but estimated from the measurable signal feature [2].

On-line monitoring of the cutting process and determining the exact time when it is necessary to replace the cutting edge during the cut (because of termination of durability or other failure of cutting edge – i.e., tool breakage) increases productivity and reduces costs [1, 4, 5, 6].

There are many ways to diagnose the cutting edge and monitor tool wear during cutting, but none of these diagnostic methods are as yet widespread – mainly because of the difficulty of monitoring and evaluation, special requirements for use, requirements for instrumentation and high value.

The vast amount of literature in this field suggests that a variety of process parameters in the metal cutting environment can be tapped and used to predict the cutting tool-state. There are some typical applications scenarios along with their correlation to tool wear under experimental conditions. It is provided to cover [7]:

- acoustic emission,
- tool temperature,
- cutting forces (static and dynamic),
- vibration signature (acceleration signals), and
- miscellaneous methods such as ultrasonic, pneumatic and optical measurements, workpiece surface finish quality, workpiece dimensions, stress/strain analysis and spindle motor current.

Uehara developed an insert coated with an electric resistance film perpendicular to the side cutting edge on the flank face [8]. In other literature can be found an insert with electric resistance film, which is parallel to the cutting edge on the end and side flank faces [9].

## 2 Experimental work

Experimental work was carried out in longitudinal turning. Special turning tool XCSRNR2525M-1207SEN was used (Fig. 2 and 3) with Inserts – Silicon Nitride Ceramic KS6000. Inserts have an impedance layer. Conductive thin film band of titanium nitride (TiN) on flank faces of ceramic insert is an insulation material. The conductive band is parallel to the cutting edge (Fig. 1).

Tool holder and inserts were specially built for experimental purpose. Inserts and tool holder were lent by Kyocera Industrial Ceramics Corp. [18]. This insert is suitable for roughing process and for high speed milling of cast iron, such as cylinder blocks. In this experiment cutting machine: MASSTROJ TROJAN C11 MV was used.

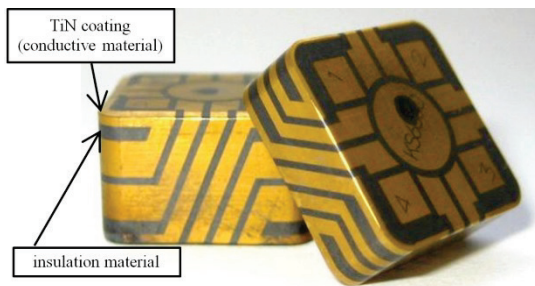

Figure 1 Cutting inserts– roughing and finishing (Silicon Nitride Ceramic KS6000) with impedance layers



Figure 2 Tool holder with contacts for the transmission of electrical signals



Figure 3 Tool holder with insert

The simple principle of the method of tool wear monitoring process is presented in Fig. 4.

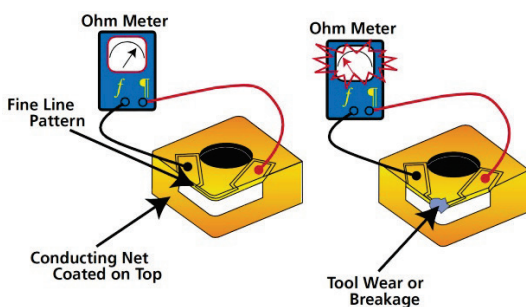

Figure 4 Principle of the method of on-line monitoring tool wear [13]

Table 1 Mechanical properties of workpiece

Mechanical properties of workpiece material cast iron 25P(EN GJL-250)			
Strength limit	$R_m$	MPa	min 250
Hardness	$HB$	-	max 240
Elastic modulus	$E$	GPa	125,9

The workpiece profiles were the tubes: outside diameter  $D = 82,5$  mm, wall thickness  $h = 6$  mm and length  $l = 130$  mm. The workpiece material was a cast iron 25P, (EN GJL-250, DIN 1691/GG 25, ČSN 42 2425)

perlite structure (with a small amount of ferrite) with lamella graphite.

Cutting parameters were almost constant during the experiment. The cutting speed was changing according to the diameter of the cutting layer. In each workpiece 3 tool patches (stock removals) with a length of 100 mm were realized.

Table 2 Cutting conditions

Cutting conditions			
Cutting speed	$v_c$	m/min	520; 500; 480
Spindle revolution	$n$	1/min	2000
Feed	$f$	mm/ot	0,1
Depth of cut	$a_p$	mm	1,5
Cutting length	$l$	mm	100
Major cutting edge angle	$\kappa_r$	°	55
Cutting process without cooling			

### 2.1 Electrical resistance monitoring

The electrical resistance of impedance layers of inserts was measured during the tests. The measurement was performed using the following devices:

- special inserts with an impedance layer,
- tool holder with sockets for the electric circuit,
- Almemo connector ZA9003FS for measurement of electrical resistance,
- universal datalogger ALMEMO 2590-4S,
- jumper cables with a USB port,
- personal computer (software AMR-Control).

### 2.2 Measurement of cutting temperature

The electrical resistance can be affected by the cutting temperature. Due to the special adjustment of the tool holder (resistive layer which consists of an electric circuit) the possibility of thermo coupled temperature measurements were avoided because of the effect on the measured electric circuit. One of the possibilities for cutting temperature measurement is by utilizing non-contact optical methods.



Figure 5 Infrared MAURER-KTR 1085-1 pyrometer [19]

Temperature was measured using an infrared MAURER-KTR 1085-1 pyrometer (Fig. 5), (temperature range: 550 °C to 1800 °C). Data were recorded using an ALMEMO connector ZA9601FS (range  $\pm 32$  mA) and ALMEMO 2590-4S datalogger connected to a PC.

The following figures (Fig. 6 and Fig. 7) show the measurement scheme. The number of the cut multiplied by 100 indicates the length of machining in mm.

The tool wear was measured by microscope with an installed digital camera. To read the wear values was used Motic image version 2.

Sets of obtained experimental values are so extensive that only the processed data in the form of graphs are

published. Representative samples of monitoring cutting processes are selected from all the experiments.



Figure 6 Measurement scheme of experiments

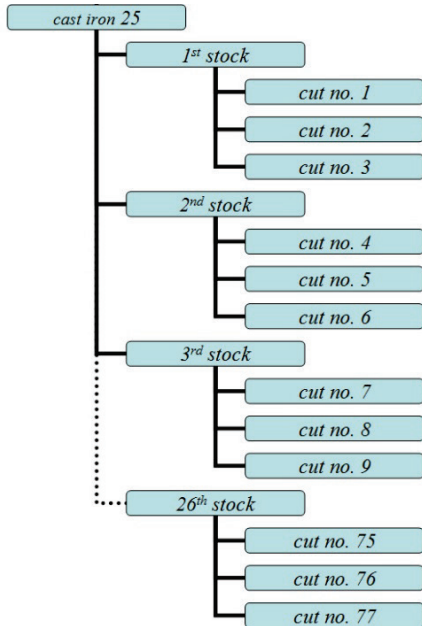

Figure 7 Scheme of experiments

### 2.3 Electrical resistance

The value of the electrical resistance is determined by the material, shape and temperature of the conductor. The quantity of resistance depends on the conductor length (directly proportional), on the size of conductor cross section (indirectly proportional), on the conductor material (electrical resistivity) and on the temperature.

Electrical resistance can be determined from the characteristics of the conductor according to the relation:

$$R = \frac{\rho \cdot l}{S}, \Omega \tag{1}$$

Where  $\rho$  ( $\Omega \cdot m$ ) is electrical resistance,  $l$  (m) is conductor length,  $S$  ( $m^2$ ) is size of the conductor cross-section.

The dependence of electrical resistance of a conductor on temperature can be expressed by the relation:

$$R = R_0(1 + \alpha \cdot \Delta t), \Omega \tag{2}$$

Where:  $R_0$  ( $\Omega$ ) is the conductor resistance in normal temperature,  $\alpha$  (1/K) is temperature coefficient of electric resistance,  $\Delta t$  is temperature difference.

### 2.4 Monitoring of cutting process

On each stock three cuts were made, each stock with the length 100 mm.

Fig. 8 illustrates the typical graphic record of the experiment. Another cut shows similar results.

The curve of cutting temperature in the graph is blue. The curve starts at the beginning of the recording optical pyrometer measurements, i.e. 550 °C.

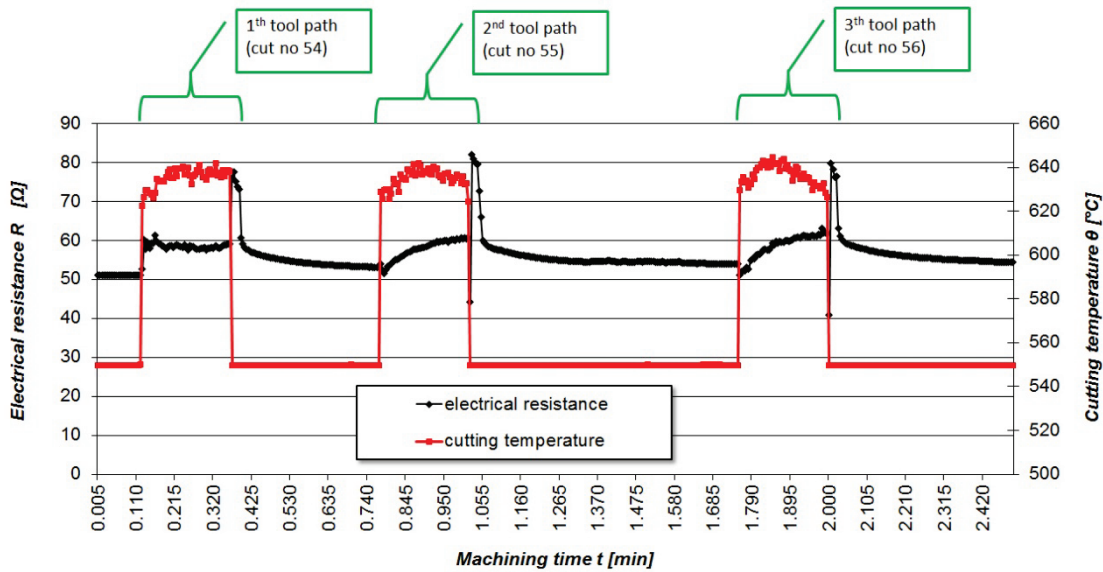

Figure 8 The dependence of electrical resistance and cutting temperature on the machining time for cuts no. 54, no. 55, no. 56

From Fig. 8 it is evident that during tool entering to the cut the cutting temperature suddenly rises and at the same time electrical resistance as well. In the cut no. 54 is visible the constant cause of electrical resistance. In the next cut, no. 55, and the next cut, no. 56, is visible

increasing of electrical resistance that corresponds to the increasing tool wear. There is amplitude of electrical resistance at the end of the cut. There is a sudden increase or decrease of electrical resistance and immediate fall down of the value that gets equal to the end of the cut.

Changing the temperature difference affects the electrical resistance.

Consequently there is a light decrease in the electrical resistance to the "starting value" during the crossing of the tool to the beginning of the next cut. The electrical resistance does not fall to zero, but to the value corresponding with the electric system and with practical influence on resistance layer wear, potential created built up edge with other particles arising in the machining process.

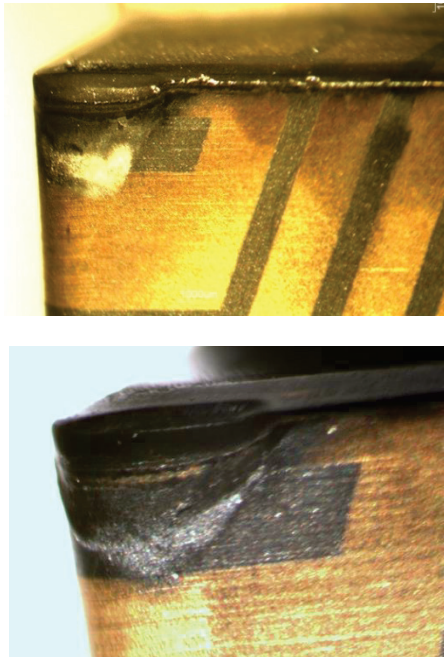

Figure 9 The back of cutting tools with scalloped dust elements

Cutting temperature course can be described as constant invarious cuts. There is only a range of values about 20 °C. During the crossing of the tool to the beginning of the next cut, the cutting temperature falls to the starting measurement temperature, which optical pyrometer is capable of recording (i.e. 550 °C).

The size of conductor cross-section (S) especially has a significant effect on the monitoring process. The impedance layer is worn during the cutting process and thus reduces its cross section. This is reflected in the increasing value of resistance.

Some workpiece types may cause a buildup of the edge [14, 15, 5]. Due to the decreasing impedance layer (caused by tool wear) the conductive built up of edge may create a wire cross-over, i.e. conducting electric current. The resulting electrical resistance may not correspond to the wear of the impedance layer.

During the cutting process, dust formation increased due to the high content of carbon in the workpiece. The workpiece material does not lead to the built up edge of the tool face, but to the back. The built up edge was created on the back due to the scallops of dust elements (Fig. 9).

The built up edge on the back does not cause destruction of the edge because of the circumstances of its creation when compared to the built up of edge on the face [14, 16, 17, 6]. This built up edge especially influences the beginning and the end of measurement of resistance of separate cuts.

Changes in temperature can significantly affect the measured resistance according to the Eq. (2). The temperature coefficient of electrical resistance  $\alpha$  was determined by detection of the resistance by heating a ceramic cutting tool according to Eq. (3). The calculation is based on the modified Eq. (2).

$$\alpha = \left( \frac{R - R_0}{R_0 \Delta t} \right), 1/K. \tag{3}$$

Substituting the temperature difference between room temperature and cutting temperature and adding the calculated temperature coefficient of electric resistance  $\alpha$  in Eq. (2), the electrical resistance value of impedance layers is affected by cooling after the cut is obtained, which is approximately equal to the value of peak electrical resistance obtained by measuring (Fig. 10).

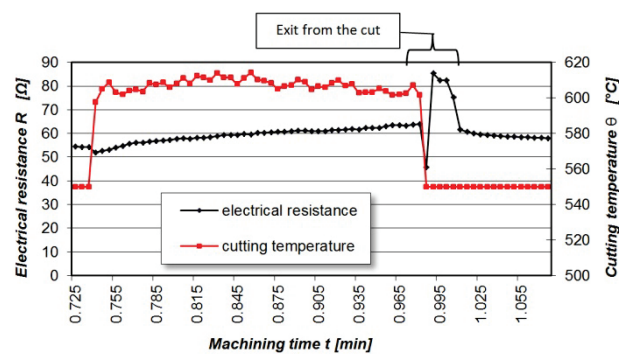

Figure 10 The dependence of electrical resistance and temperature on the machining time – record details of a cut no. 58

Fig. 10 shows a detail (a period of 15 seconds) in which the tool has been cut. There are more visible amplitudes of electric resistance after exit from the cut.

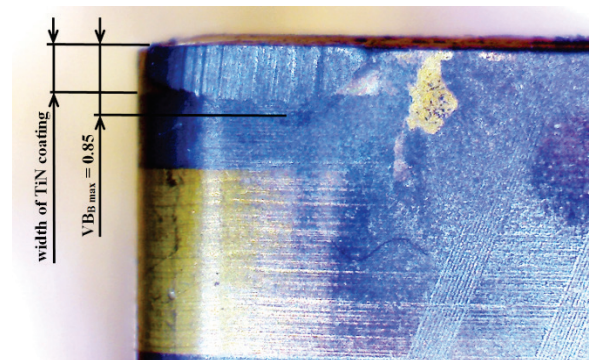

Figure 11 Tool wear with break up impedance layer

Fig. 13 shows the comparison of tool wear with electric resistance in the cutting time 19 min (i.e. the sum of individual cuts of one exchangeable cutting edge). The tool live criterion was  $VB_{crit} = 0,35$  mm.

In the first two minutes the progressions do not correspond. This is due to the distance of the first impedance layer from the cutting edge. For practical machining process monitoring is not essential. This dispute can be neglected. Following minutes of cut indicate a very good correspondence and thus the possibility of practical application of methods for monitoring the cutting process.

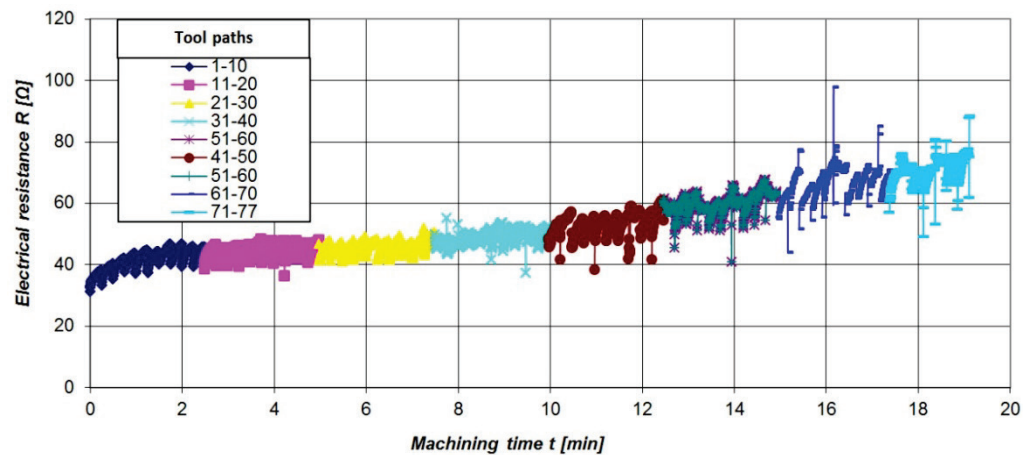

Figure 12 The dependence of electrical resistance on the machining time – consecutive cuts

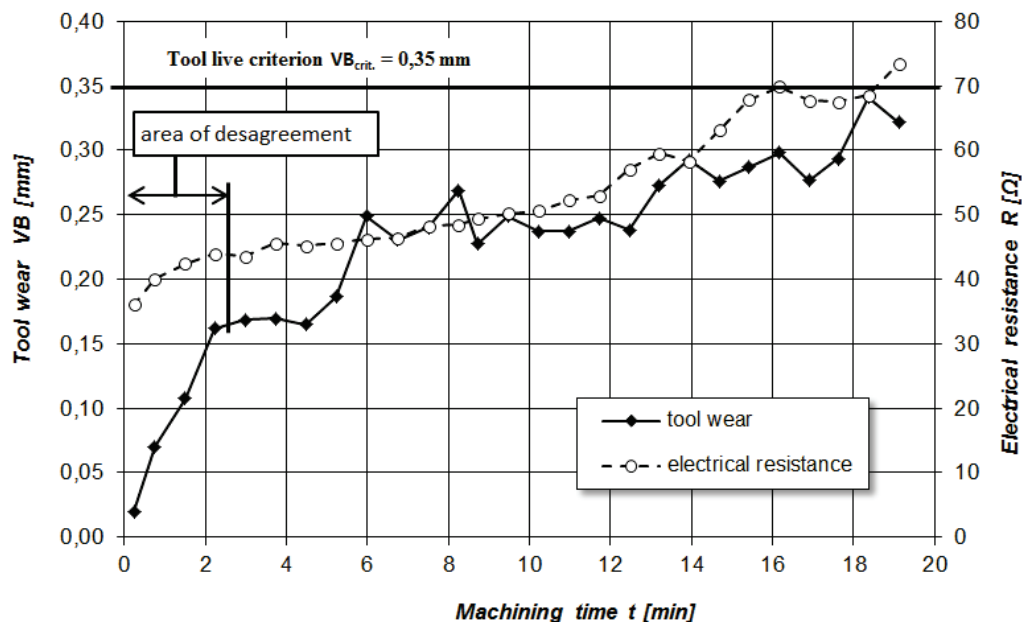

Figure 13 The dependence of tool wear VB on the machining time

### 3 Discussion and conclusions

Impedance layer behavior is such a complicated phenomenon that the current status of the experiment cannot clearly determine the course of correlation between them.

The impedance layer was applied to inserts made of nitride ceramics. The width of this layer determines the wearing allowance of the tool wear (flank wear). Excessive tool wear causes a sharp reduction of this layer and thus a sharp increase in electrical resistance, which is a warning signal of end of durability of the cutting edge.

In case the measuring sensor has no signal, the impedance layer has broken up. This means that the criterion of tool wear on the back of cutting tool was achieved. The absence of an electrical signal indicates interruption of the cut and change of the cutting edge or cutting tool.

The method of cutting tool diagnostics using the independence layer has potential for expansion into practice. This method may be suitable for computer numeric control machines, flexible manufacturing systems and other types of automated production lines.

This method opens up wide possibilities for its simplicity and easy application.

### Acknowledgements

This paper was supported by the ESF in the Czech Republic, name of project: Education system for personnel resource of research and development in the field of a modern trend of surface engineering – surface integrity, reg. no. CZ.1.07/2.3.00/20.0037 and by the Czech Science Foundation, Student Grant Competition (SP2013/98), VSB-Technical University of Ostrava.

### 4 References

- [1] Castejon, M.; Alegre, E.; Barreiro, J.; Hernandez L. K. On-line tool wear monitoring using geometric descriptors from digital images. // *Int. J. Mach. Tools Manuf.* 47, (2007), pp. 1847-1853.
- [2] Ghani, J. A.; Rizal, M.; Nuawi, M. Z.; Ghazali, M. J.; Haron, C. H. C. Monitoring online cutting tool wear using low-cost technique and user-friendly GUI. // *Wear.* 271, (2011), pp. 2619-2624.
- [3] Sick, B. On-line and indirect tool wear monitoring in turning with artificial neural networks: a review of more

- than a decade of research. // *Mech. Syst. Signal Process.* 16, 4(2002), pp. 487-546.
- [4] Giusti, F.; Santochi, M.; Tantussi, G. On line sensing of flank and crater wear of cutting tools. *CIRP*, 1/1987, pp. 41.
- [5] Tamizharasan, T.; Senthil Kumar, N. Optimization of Cutting Insert Geometry Using DEFORM-3D: Numerical Simulation and Experimental Validation. // *International Journal of Simulation Modelling*. 11, 2(2012), pp. 65-76.
- [6] Čep, R.; Janásek A.; Čepová, L.; Petrů, J.; Hlavatý, I.; Car, Z.; Hatala, M. Experimental testing of cutting inserts cutting ability. *Tehnicki vjesnik/Technical Gazette*. 20, 1(2013), pp. 21-26, 1/2013, ISSN: 1330-3651.
- [7] Dimla, E. Sensor signals for tool-wear monitoring in metal cutting operations - a review of methods. // *International Journal of Machine Tools and Manufacture*. 40, (2000), pp. 1073-1098.
- [8] Uehara, K. New Attempts for Short Time-Life Testing. // *Annals of the CIRP*. 22, 1(1973), pp. 23-24.
- [9] Sekiya, K.; Yamane, Y.; Torimoto, A. Tool life Detecting System. // *JSME International Journal, Series C*. 49, 2(2006).
- [10] ISO 3685:1993. Tool-life testing with single-point turning tools, International Organization for Standardization, Geneva, 48 p.
- [11] Sadílek, M.; Čep, R. Budak, I.; Sokovic, M. Aspects of Using Tool Axis Inclination Angle. // *Strojníski vestnik - Journal of Mechanical Engineering*. 57, 9(2011), pp. 681-688.
- [12] Sadílek, M.; Čep, R.; Sadílková, Z.; Valíček, J.; Petřkovská, L. Increasing tool life in turning with variable depth of cut. // *Materiali in tehnologije/Materials and Technology*. 47, 2(2013), pp.199-203.
- [13] Richter, A. Plugging in - New lathe tool offers direct in-process diagnosis of cutting process. // *Cutting Tool Engineering Magazine*. 53, 1(2001).
- [14] Gökçaya, H. The Effects of Machining Parameters on Cutting Forces, Surface Roughness, Built-Up Edge (BUE) and Built-Up Layer (BUL) During Machining AA2014 (T4) Alloy. // *Strojníski vestnik - Journal of Mechanical Engineering*. 56, 9(2010), pp. 584-593.
- [15] Mgwatu, M. I. Integrated approach for optimising machining parameters, tool wear and surface quality in multi-pass turning operations. / *Advances in Production Engineering & Management*. 8, 4(2013), pp. 209-218.
- [16] Antic, A.; Petrovic, B.P.; Zeljkovic, M.; Kosec, B.; Hodolic, J. The influence of tool wear on the chip forming mechanism and tool vibrations. // *Materiali in tehnologije / Materials and Technology*. 46, 3(2012), pp. 279-285.
- [17] Antić, A.; Kozak, D.; Kosec, B.; Šimunović, G.; Šarić, T.; Kovačević, D.; Čep, R. Influence of tool wear on the mechanism of chips segmentation and tool vibration. // *Tehnicki vjesnik-Technical Gazette*. 20, 1(2013), pp. 105-112.
- [18] Kyocera Industrial Ceramics Corp. - cutting tools products. [http://americas.kyocera.com/KICC/ceratip/grades\\_ceramic.html](http://americas.kyocera.com/KICC/ceratip/grades_ceramic.html). [cit. 2009-05-10].
- [19] Maurer, G. GmbH - Optoelektronik- non contact temperature measurement. Serie KTR 1085. [online] <http://www.maurer-ir.de/> [cit. 2009-10-20].

#### Authors' addresses

##### **Marek Sadílek, Assoc. Prof., Ph.D., Msc.**

VŠB-Technical University of Ostrava  
Faculty of Mechanical Engineering  
Department of Machining and Assembly  
17. listopadu 15, 708 33 Ostrava, Czech Republic  
E-mail: marek.sadilek@vsb.cz

##### **Jiří Kratochvíl, Ph.D., Msc.**

VŠB-Technical University of Ostrava  
Faculty of Mechanical Engineering  
Department of Machining and Assembly  
17. listopadu 15, 708 33 Ostrava, Czech Republic  
E-mail: jiri.kratochvil@vsb.cz

##### **Jana Petrů, Ph.D., Msc.**

VŠB-Technical University of Ostrava  
Faculty of Mechanical Engineering  
Department of Machining and Assembly  
17. listopadu 15, 708 33 Ostrava, Czech Republic  
E-mail: jana.petr@vsb.cz

##### **Robert Čep, Assoc. Prof., Ph.D., Msc.**

VŠB-Technical University of Ostrava  
Faculty of Mechanical Engineering  
Department of Machining and Assembly  
17. listopadu 15, 708 33 Ostrava, Czech Republic  
E-mail: robert.cep@vsb.cz

##### **Tomáš Zlámal, Msc.**

VŠB-Technical University of Ostrava  
Faculty of Mechanical Engineering  
Department of Machining and Assembly  
17. listopadu 15, 708 33 Ostrava, Czech Republic  
E-mail: tomas.zlamal.vsb@seznam.cz

##### **Dana Stančeková, Assoc. Prof., Ph.D., Msc.**

University of Žilina  
Faculty of Mechanical Engineering  
Department of Machining and Manufacturing Engineering  
Univerzitná 8215/1, 010 26 Žilina, Slovakia  
E-mail: dana.stancekova@fstroj.uniza.sk