

Evaluation of the effect of axial load on the structural behaviour of segmented tunnels

Arturo Galván and Fernando Peña

Instituto de Ingeniería, Universidad Nacional Autónoma de México, Circuito Escolar,
Ciudad Universitaria, 04510 Mexico City, MEXICO
e-mail: AGalvanC@iingen.unam.mx

SUMMARY

The aim of this paper is to study the effect of the interaction between rings produced due to the axial load (and owing to the nature of the constructive process) on the structural behaviour of segmented tunnels. This analysis was performed by using a non-linear analysis with the Finite Element Method (FEM). Considering non-linear behaviour of the material, the segments were modelled by using 3D solid elements. Segment joints and ring joints were modelled by using contact elements. The results indicate that the axial load resulting from the interaction between the rings changes the structural behaviour of the lining in that its structural capacity is increased.

Key words: segmented tunnel, segment joint, ring joint, axial load, structural capacity.

1. INTRODUCTION

In recent years, one of the popular methods used in the construction of tunnels in soft soils has been the shield method or TBM (Tunnel Boring Machine) method. The advantage of using this construction technique is that it allows simultaneously both the excavation of a tunnel and the placement of a primary lining consisting of precast segments serving as temporary or permanent support to the excavation. The basic parts forming a segmented tunnel are depicted in Figure 1; obtained from Ref. [1]. The segments are usually made of reinforced concrete and are set by the TBM at the same time while the excavation is under way. A joint is located between the segments (longitudinal joint), as well as between the rings (lateral joint). Precisely for this reason the segmented tunnels cannot be considered as a continuous ring, therefore the effect of these joints must be considered during the calculation of internal forces and displacements in the ring. Generally, these joints transfer the forces directly by contact between the surfaces of concrete without

any need for additional connection. It is assumed the presence of significant axial forces would ensure continuity between the various elements of the lining.

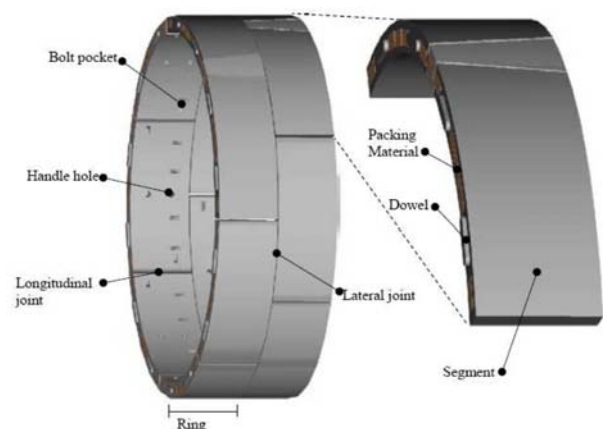

Fig. 1 Basic parts of a segmented tunnel [1]

The importance of the joints has been recognized by several authors [2-7] who have studied analytically the mechanical behaviour of segment joints (moment-rotation behaviour); while experimental tests have been

performed so far seldom [8-12]. Some of the conclusions reached in the above-mentioned studies are: a) the number of joints and their orientation are two important factors for the stress level that acts in the ring; b) increasing the segment joints in a ring causes the bending moment and the acting forces to decrease; c) the rotational stiffness of the joint depends on the acting loads on it; d) the mechanical behaviour of the segment joints does not only depend on its geometry and material, but also on the applied loads and the type of connection used.

On the other hand, researches on the behaviour of rings have also been performed. Gijsbers and Hordijk [13] performed an experimental research on the shear stiffness between rings. In this study, they concluded that the ring joints depend on shear behaviour of contact surfaces (load-deformation behaviour). The shear strength of these joints depends on the axial load in the lining and the friction coefficient between surfaces. Thus, the behaviour of the segment joints and the ring joints depends on the acting loads in the rings. Likewise, it is possible to divide the acting loads on a tunnel in radial, tangential and axial load. The radial and tangential loads are produced by water and soil pressures on the lining while the axial load is given for the constructive process of a tunnel. This axial load is induced in the segmented rings through the thrust cylinders of the TBM producing an interaction between rings which affects the structural behaviour of the lining.

Finally, the aim of this paper is to investigate into the effects of the interaction between rings produced due to the axial load on the structural behaviour of segmented tunnels by employing a non-linear numerical analysis.

2. METHOD OF ANALYSIS

The performed 3D non-linear numerical modelling for coupled rings of tunnels is done by means of Finite Element Method (FEM). The geometry of a typical railway tunnel was taken as the basis for the analysis. Each ring consists of 7 segments plus a keystone. The internal diameter of rings is 8650 mm, the segment thickness and width are 400 mm and 1500 mm, respectively (Figure 2). Figure 3(a) shows the non-linear numerical model for the performed analysis.

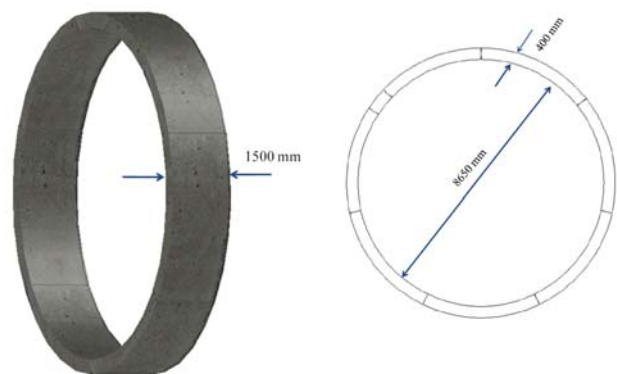

Fig. 2 Geometry of a typical railway tunnel

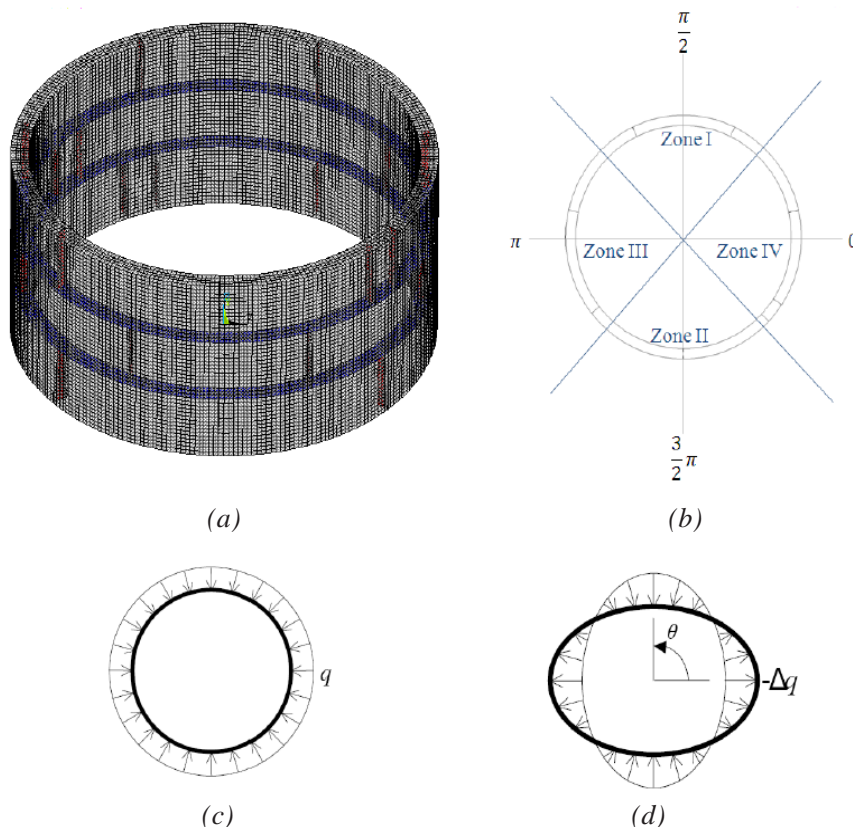

Fig. 3 Model of segmented rings: (a) numerical model; (b) scheme for the delimited zones; (c) diagram of uniform radial load [14]; and (d) diagram of ovalisation load [14]

Furthermore, different values of the axial load were used in the analysis to evaluate the effect of the load on the structural capacity of lining. The maximum axial load used in the analysis corresponds to a half of the average axial load on a tunnel [14]. This is so, since once the TBM is moved, the axial load considered like residual load is equivalent to half the average axial load at the tunnel. This axial load value was additionally varied for the other numerical models including the consideration of the zero axial load for the case of a single ring model. This methodology is a novelty compared with the usual analyses that employ single ring models.

On the one hand, if a high axial load appears in the tunnel, a “strong” interaction between the rings is expected. This type of axial load is equivalent to half the average axial load on the tunnel [14]. On the other hand, if a low axial load appears on the tunnel, a “weak” interaction should develop between the rings. This kind of axial load corresponds to a one sixteenth of the average axial load on the tunnel [14]. Figure 3(b) shows four zones at the lining presenting thus the illustration of the numerical results shown in section 3.

2.1 Description of FE models

The segments were modelled by using 8-node solid elements [15]. These elements are suitable since are able to take into account concrete behaviour and are capable of simulating the cracking of concrete in tension and crushing in compression; moreover the steel reinforcement can be modelled as smeared steel layer (volume ratio).

The joints were modelled by the use of contact elements which are suitable for the creation of discontinuous finite element models. Therefore, these elements can be used to model the following characteristics:

- The closure or opening of joints is allowed, as well as slip;
- When the joint is closed, the transmission of compressive and shear stresses is possible, but not of tensile stresses;
- When the joint is opened, there is no transmission of stresses;
- The transmission of shear stresses is carried out according to Coulomb's law;
- Changes in the geometry are detectable thanks to the relative movement of the elements forming the joint.

The contact between the surfaces was considered as perfectly rough, a case corresponding to an infinite friction coefficient where the rotation of segment joints is considered exclusively. Furthermore, the slip between the surfaces in the ring joints was taken into consideration according to Coulomb's law.

The non-linear properties of concrete were defined by means of: the uniaxial tensile cracking stress (f_{ct}), the shear transfer coefficients of an opened and closed crack (β_T and β_C). Besides concrete, the reinforcing steel was included by using a volume ratio (ρ_l and ρ_t), defining a stress-strain curve including the strain hardening of steel. The Drucker-Prager yield surface was used to include the plastic deformations of concrete. For this reason, the following parameters were also defined: cohesion (c), angle of internal friction (ϕ) and dilatancy angle (ψ). The values of these parameters are shown in Table 1 [14]. It should be noted that the uniaxial crushing stress (f'_c) was considered as elastic since the failure is a consequence of tensile cracking and not of compressive crushing.

2.2 Load protocol

As the first step, the effects of thrust cylinders of the TBM were included into the numerical model by means of an axial load of 800 kN/thrust cylinder, a value equivalent to a half of the average axial load on the tunnel [14]. Likewise, to simulate the effect of soil pressures on the tunnel, a radial load was applied. This load was divided in two parts: a uniform part and an ovalisation part (Figures 3(c) and 3(d)). The uniform part of the radial load is mainly determined by the depth at which the tunnel is located [14], whereas the ovalisation part of the radial load is determined by the kind of soil in which the tunnel is situated. The ovalisation load is obtained by equation:

$$p = q - \Delta_q \cos(2\theta) \tag{1}$$

where p is the final radial load (uniform and ovalisation load); q is the uniform radial load; Δ_q is the ovalisation radial load; and θ is the circumferential angle.

In the numerical models, the ovalisation load was applied until the segmented rings reached their failure point (damage in segments and/or excessive rotations of segment joints).

Different values of axial load were taken into account in the evaluation of the load effect on the behaviour of these structures, including a model without the axial load (model of a single ring).

Table 1 Non-linear properties used in numerical models

Material	f_{ct} (N/mm ²)	ν	E (N/mm ²)	β_C	β_T	f_y (N/mm ²)	f'_c (N/mm ²)	c N/mm ²	ϕ (rad)	ψ (rad)
Concrete	4.0	0.2	36000	1	0.01	---	elastic	26	0.17	0.1
Steel	---	0.2	205939.65	---	---	411.88	---	---	---	---

3. NUMERICAL RESULTS

A comparison between the numerical model with a “strong” interaction between rings (axial load = 800 kN/thrust cylinder) and the numerical model with a “weak” interaction between rings (axial load = 100 kN/thrust cylinder) [14]; and the models that take “no interaction” between rings into account (single rings without axial load) was performed.

Figures 4(a) and 4(b) show the deformed configuration of segmented rings after the application of the axial load. The maximum displacement calculated according to the numerical model with the weak interaction is of 0.015 mm while the model with the strong interaction shows a maximum displacement of 0.123 mm. This value is approximately 8 times the

obtained value for the weak interaction. The displacement is increased at the same rate as the axial load rate since the materials are in their elastic phase. Later, the models were subjected to a uniform radial load and an ovalisation radial load. After the radial load (ovalisation part) had been applied, the results showed that in both models the maximum displacements were located on $0, \pi/2, \pi, 3\pi/2$ rad (see Figure 2(d)), especially where the location of segment joints coincides with the zones pointed out in Figure 4(c). It is important to note that in the model with weak interaction the displacements exhibit less uniformity between the rings than in the model with strong interaction. The phenomenon is more pronounced in the central ring of the models and occurs because the axial load applied in the models produces coupling between the rings.

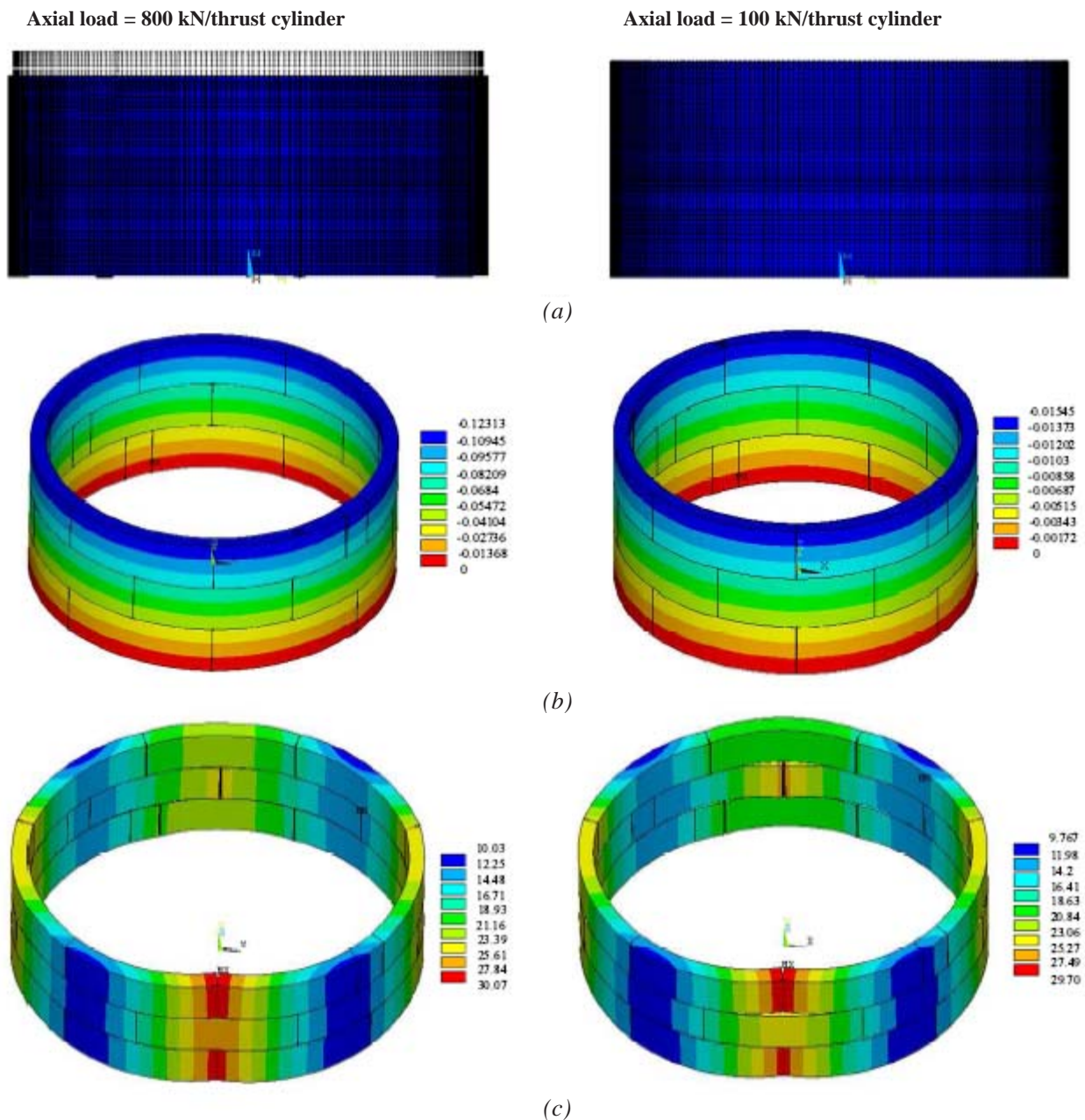

Fig. 4 Numerical results of segmented rings: (a) deformed configuration after the axial load (scale factor 4000); (b) displacements “Z” after the axial load; and (c) total displacements after the ovalisation load (scale factor 25)

Figures 5(a) and 5(b) show the stress maps for both numerical models (strong and weak interaction models) including the stress maps of the numerical model that takes into account single rings. In this figure, the zones (outlined in Figure 2(d)) where the maximum tensile stresses are located appear at inside the lining of

zones I and II; and outside the lining of zones III and IV. Cracking develops in the same zones where the maximum tensile stresses appear. However, if a segment joint is located in these zones it will prevent the cracking due to its mechanical behaviour (Figures 5(c) and 6).

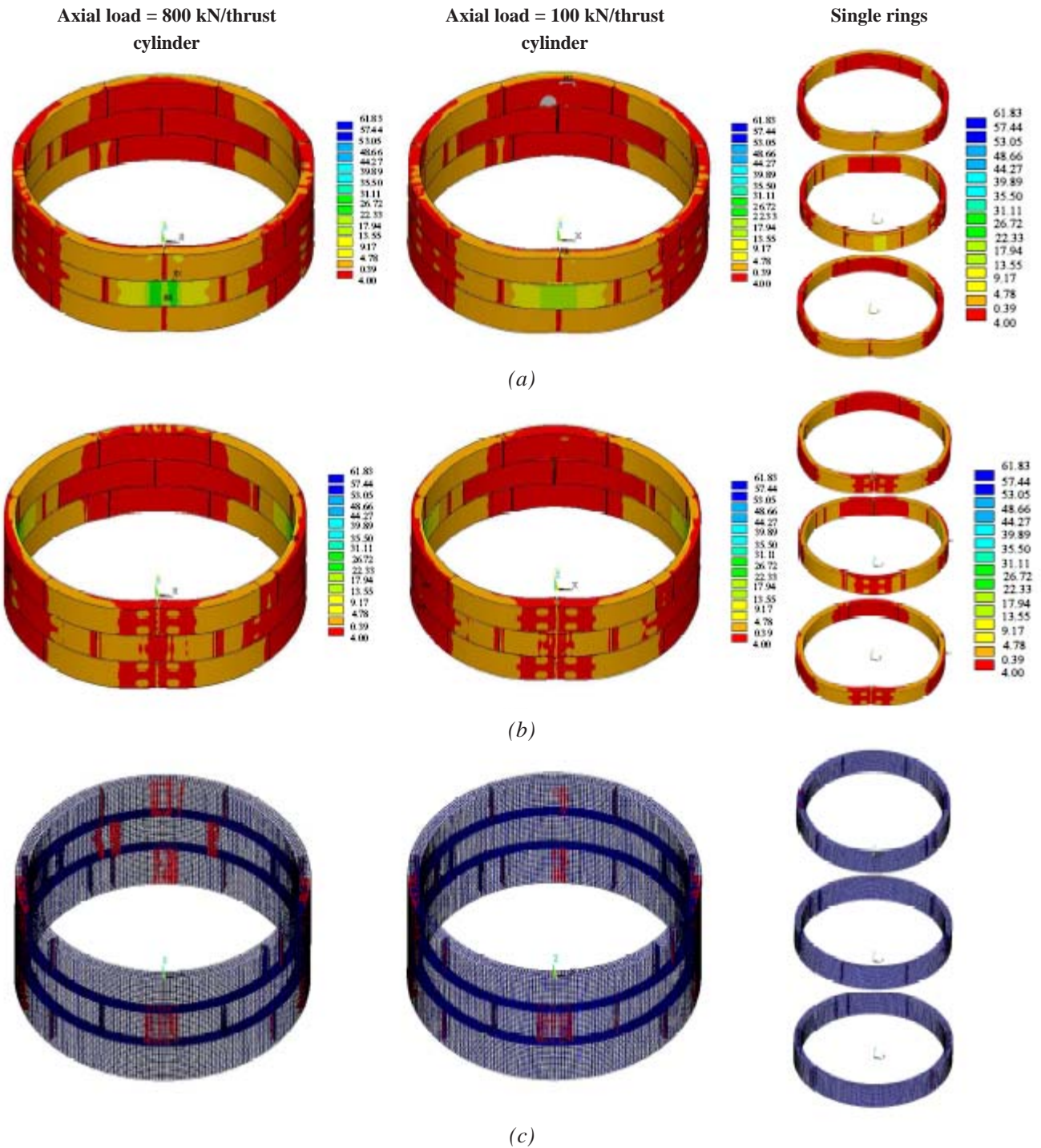

Fig. 5 Stress maps and cracking in the segmented rings: (a) stress maps “X” (scale factor 25); (b) stress maps “Y” (scale factor 25); and (c) cracking

According to Figure 6, the cracking obtained in single rings practically does not exist. The deformation of longitudinal reinforcement is shown in Figure 7.

In the numerical model with strong interaction between the rings, the maximum strains in the reinforcement (value of 0.002) were located in the zones I, III and IV of the three rings, including zone II of the central ring.

In the numerical model with weak interaction between rings, the maximum strains in the

reinforcement were located in the zones III and IV of the three rings, including zone II of the central ring.

On the other hand, in single rings the strains of longitudinal reinforcement were smaller than in the others models. The outlined results indicate that the structural behaviour of lining depends more on the longitudinal reinforcement of segments, because this model displayed a higher load resistance, which ultimately depends on a strong interaction between rings of a tunnel lining.

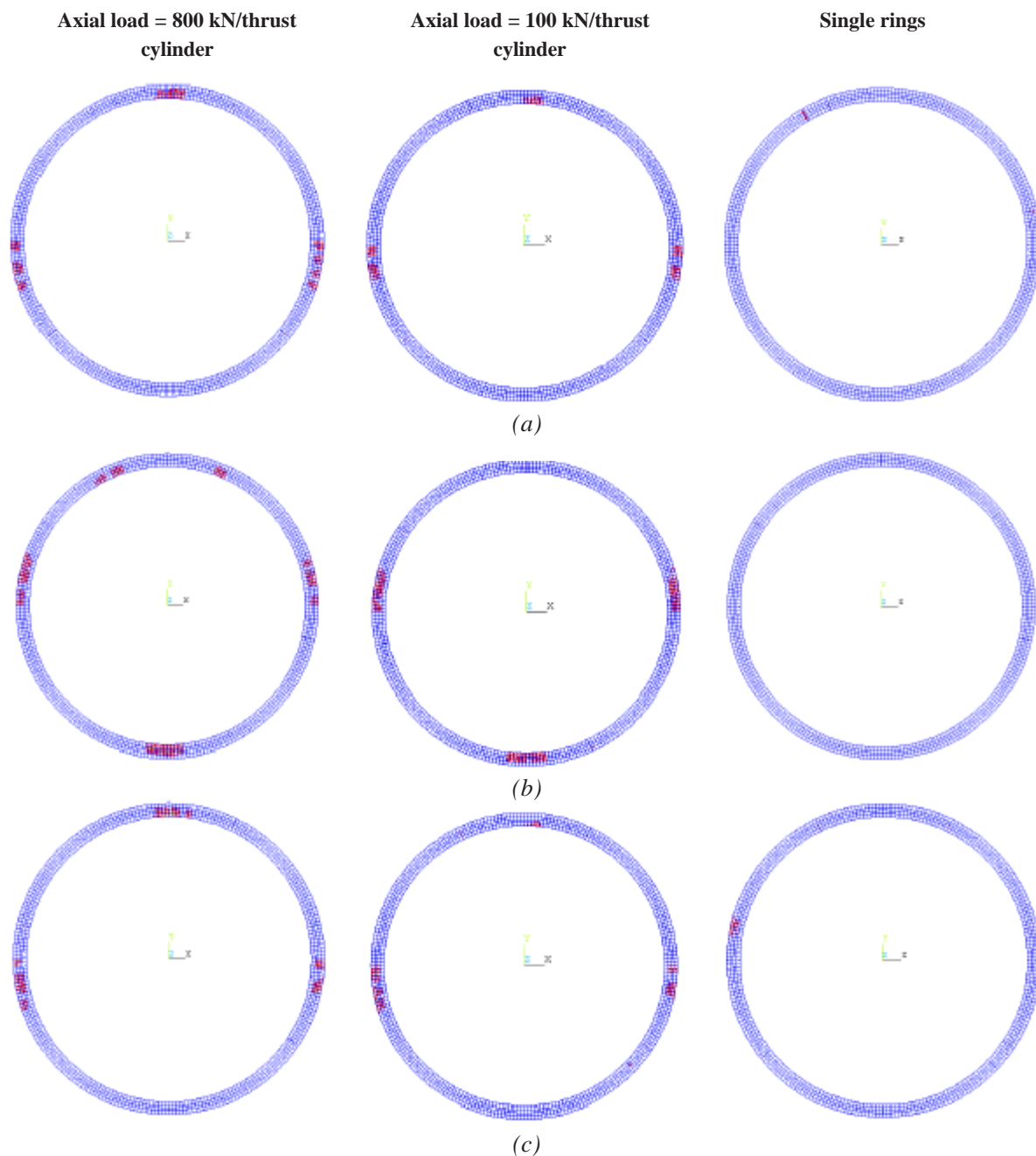

Fig. 6 Cracking development of segmented rings: (a) lower ring; (b) central ring; and (c) upper ring

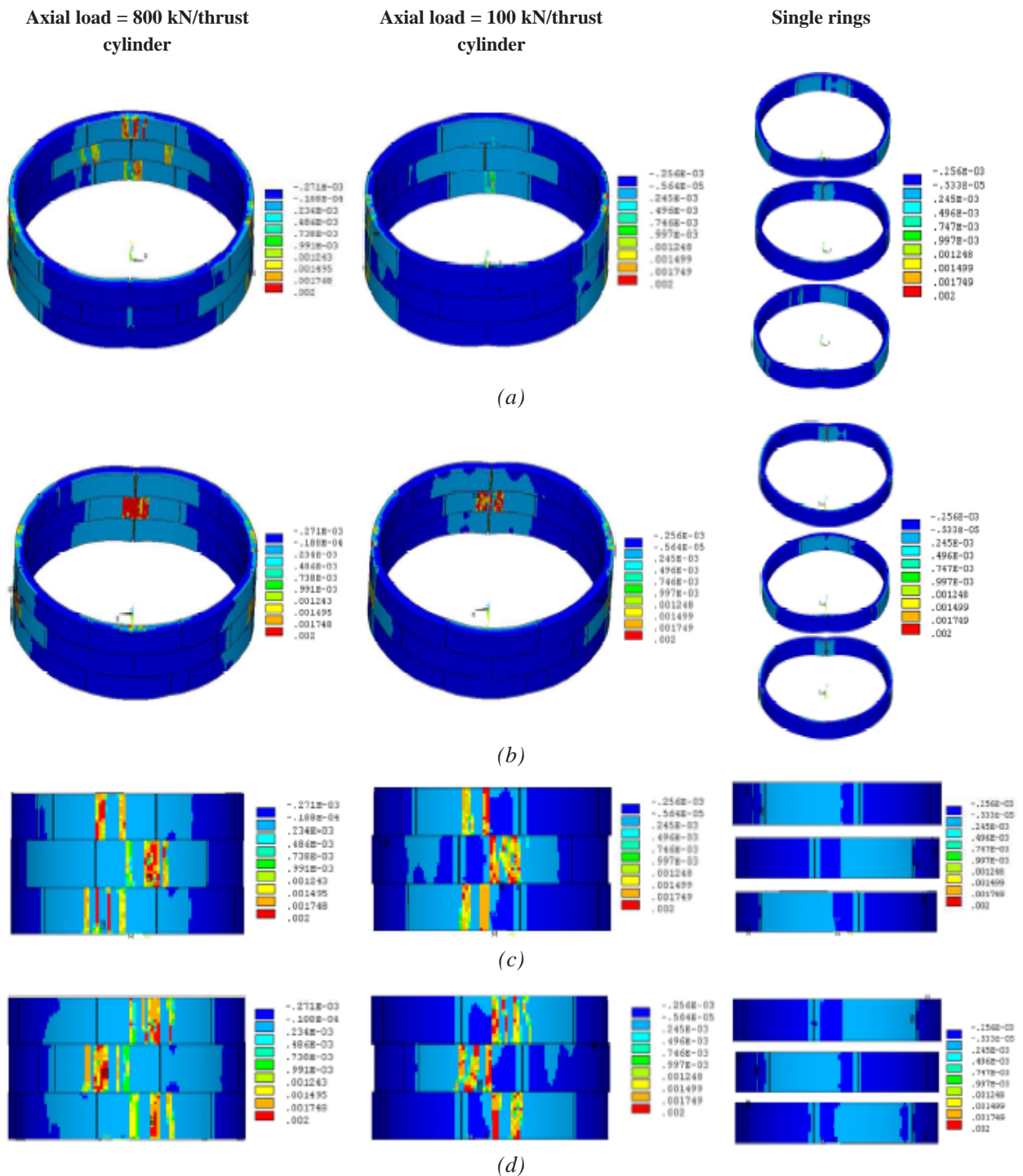

Fig. 7 Longitudinal reinforcement strain (scale factor 25): (a) isometric view 1; (b) isometric view 2; (c) right lateral view; and (d) left lateral view

For each ring of the lining, the load-deformation curves are displayed in Figure 8. It can be seen from this figure that the structural capacity of the lining for the model with strong interaction between the rings was 0.087 MPa , while the capacity of the weak interaction model was lower, 0.078 MPa . The structural capacity of the model using single rings was 0.055 MPa . Expressed in percentages, the use of single rings diminished the structural capacity of lining by 29.5% with respect to the capacity obtained by the model with weak interaction between the rings.

However, compared to the model with strong interaction between the rings, the value of structural capacity obtained by the model with single rings is lower by 36.8%. These figures indicate that the structural capacity of the lining increases with the increase of the axial load. The rationale behind this conclusion is that a high axial load is inextricably related to a strong interaction between rings, which in turn augments the structural capacity of a lining. Arguably, the structural capacity depends more on the damage in the segments (mechanical properties of concrete and

reinforcement steel of segments) than on the mechanical behaviour of segment joints (moment-rotation behaviour). Precisely for this reason single rings practically do not manifest cracking phenomenon but the failure will occur due to excessive rotations of segment joints. Therefore, when a high axial load is expected, a higher structural capacity of a segmented tunnel should be expected as well owing to the axial load effect.

Furthermore, additional analyses were performed by considering other axial loads (Figure 8) displaying the same correlation between the axial load and the structural capacity of lining.

4. CONCLUSIONS

The following conclusions were reached on the basis of the discussed analysis:

- The increase of the axial load given for the constructive process (TBM machine) increases the structural capacity of the lining of a segmented tunnel;
- The failure mode of a segmented tunnel depends

on the interaction between rings and, consequently, on the axial load. With the decrease of the axial load the structural capacity is more dependent on the rotations of segment joints than on the damage in the segments;

- The numerical models of single rings showed that the damage in the segments practically did not develop but that the failure mode occurred for excessive rotations of segment joints;
- If a very low axial load is expected in a tunnel, it would be possible to define its behaviour using single rings;
- In the evaluation of the structural behaviour of a segmented tunnel, it is essential to take the axial load effect into account so that a more precise evaluation and better understanding of the behaviour might be gained.

5. ACKNOWLEDGMENTS

The first author acknowledges the doctoral research grant of “Consejo Nacional de Ciencia y Tecnología - CONACYT” of the Mexican government.

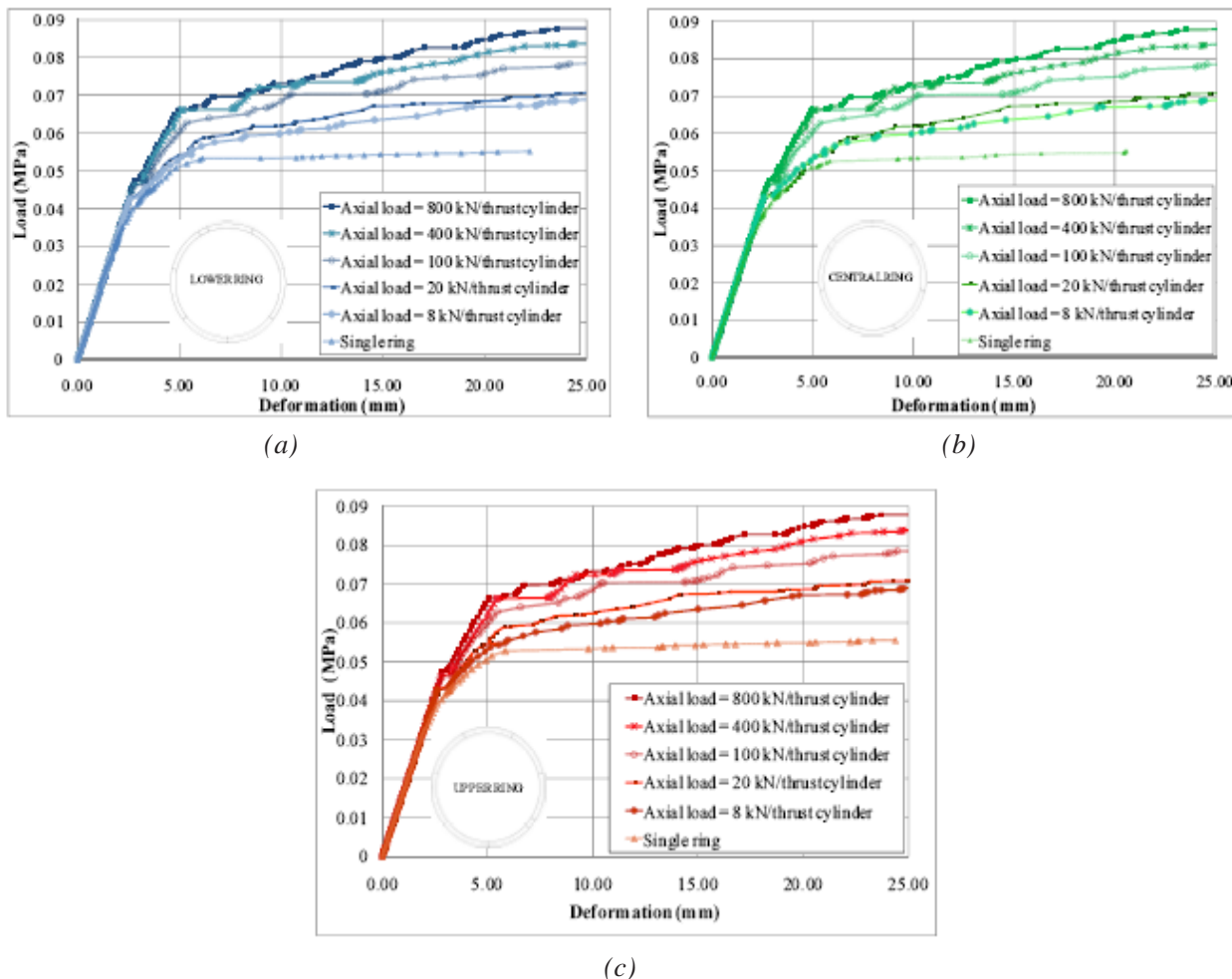

Fig. 8 Load-deformation curves of segmented rings considering different axial loads: (a) lower ring; (b) central ring; and (c) upper ring

6. REFERENCES

- [1] C.B.M. Blom, Design philosophy of concrete linings for tunnels in soft soils, Ph.D. Thesis, Delft University of Technology, Delft, 2002. (Available at: <http://repository.tudelft.nl/view/ir/uuid:dee23627-1fb0-4308-a536-6120ae1e8db5/>)
- [2] BTS, *Tunnel Lining Design Guide*, The British Tunnelling Society and The Institution of Civil Engineers, Thomas Telford Ltd, London, 2004.
- [3] C.B.M. Blom, The structural (un)safety of tunnels explained by analytical approach, *Heron*, Vol. 48, No. 1, pp. 17-32, 2003. (Available at: <http://repository.tudelft.nl/view/ir/uuid:9a3a214d-78c2-4379-a239-cfc5e5f65146/>)
- [4] A.M. Hefny, F.C. Tan and N.F. Macalevey, Numerical study on the behaviour of jointed tunnel lining, *Journal of the Institution of Engineers*, Vol. 44, No. 1, pp. 108-118, 2004.
- [5] K.M. Lee and X.W. Ge, The equivalence of a jointed shield-driven tunnel lining to a continuous ring structure, *Canadian Geotechnical Journal*, Vol. 38, No. 3, pp. 461-483, 2001.
- [6] K.M. Lee, X.Y. Hou, X.W. Ge and Y. Tang, An analytical solution for a jointed shield-driven tunnel lining, *Int. J. for Numerical and Analytical Methods in Geomechanics*, Vol. 25, No. 4, pp. 365-390, 2001.
- [7] Z. Xiaochun, Z. Wei, H. Zhengrong and H. Yuewang, Effect of joint structure on joint stiffness for shield tunnel lining, *Tunnelling and Underground Space Technology*, Vol. 21, No. 3-4, pp. 407-408, 2006.
- [8] M. Rodríguez and R. Salmón, Comportamiento estructural de dovelas para revestimiento de túneles, Segunda parte: Ensayos en Laboratorio, Report for General Directorate of Construction and Hydraulic Operation of the Department of Federal District, Institute of Engineering, Universidad Nacional Autónoma de México, 1987. (in Spanish)
- [9] D.A. Hordijk and F.B.J. Gijssbers, Laboratoriumproeven tunnelsegmenten, Internal report K100-W-026, TNO-Bouw, Delft, 1996. (in Dutch)
- [10] J. Schreyer and D. Winselmann, Suitability tests for the segmental lining for the 4th Elbe tunnel tube, Hambrug, *Tunnel*, Vol. 2/1998, pp. 30-37, 1998. (in German)
- [11] J. Schreyer and D. Winselmann, Suitability tests for the lining for the 4th Elbe tunnel tube – Results of large-scale tests, *Tunnel*, Vol. 1/2000, pp. 34-44, 2000. (in German)
- [12] S. Teachavorasinskun and T. Chub-Uppakarn, Experimental verification of joint effects on segmental tunnel lining, *Electronic Journal of Geotechnical Engineering*, Vol. 14, Bund K., 2009. (Available at: <http://www.ejge.com/2009/Ppr0992/Ppr0992.pdf>)
- [13] F.B.J. Gijssbers and D.A. Hordijk, Experimenteel onderzoek naar het afschuifgedrag van ringvoegen, CUR/COB K11-W-001, 1997. (in Dutch)
- [14] A. Lutikholt, Ultimate limit state analysis of a segmented tunnel lining – Results of full-scale tests compared to finite element analyses, M.Sc. Thesis, Delft University of Technology, Delft, pp. 29-54, 2007.
- [15] ANSYS, Documentation for ANSYS, ANSYS Workbench Release 11.0. ANSYS Inc., 2006.

PROCJENA UTJECAJA UZDUŽNOG OPTEREĆENJA NA PONAŠANJE KONSTRUKCIJE SEGMENTNOG TUNELA

SAŽETAK

Cilj ovoga rada je istražiti utjecaj međudjelovanja između prstenova nastale uzdužnim opterećenjem (nastale procesom građenja) na ponašanje konstrukcije segmentnih tunela. U radu je korištena nelinearna analiza primjenom metode konačnih elemenata (MKE). Segmenti tunela modelirani su uz pomoć 3D-solid elemenata uzimajući u obzir nelinearno ponašanje materijala. Spojevi segmenata, a isto tako i spojevi prstenova, modelirani su korištenjem kontaktnih elemenata. Rezultati ukazuju na to da uzdužno opterećenje koje proizlazi iz međudjelovanja prstenova utječe na ponašanje nosivosti primarne obloge tunela na način da joj se povećava nosivost.

Ključne riječi: segmentni tunel, spoj segmenata, spoj prstena, uzdužno opterećenje, nosivost konstrukcije.