

ROBUST CONTROL OF SHUNT ACTIVE POWER FILTER USING INTERVAL TYPE-2 FUZZY LOGIC CONTROLLER FOR POWER QUALITY IMPROVEMENT

Hakan Acikgoz, O. Fatih Kececioglu, Ahmet Gani, Mustafa Tekin, Mustafa Sekkeli

Original scientific paper

It is well-known that shunt active power filter (SAPF) is widely used to reduce harmonic distortion and to compensate reactive power in electrical power systems. DC bus voltage control of SAPF is very important for excellent power quality. In the control of SAPF, DC bus voltage is controlled by conventional control methods such as PI and PID controllers. However, these controllers cannot give good results under transient and steady state conditions. Robust and intelligent controllers are required in order to improve performance of SAPF. In this paper, interval type-2 fuzzy logic system (T2FLS) that does not require mathematical model to be controlled system is preferred for control of DC bus voltage of SAPF and compared with type-1 fuzzy logic system (T1FLS). SAPF structures with both controllers are designed and simulated using MATLAB /Simulink environment. Simulation results have shown that SAPF structure with proposed controller has superior features than T1FLS in terms of fixed DC bus voltage, total harmonic distortion and power quality.

Keywords: Interval Type-2 Fuzzy Logic Controller (T2FLS); power quality; reactive power compensation; Shunt Active Power Filter (SAPF)

Robusno reguliranje usporedno aktivnog filtra snage pomoću regulatora neizržite logike intervala tipa-2 za poboljšanje kvalitete energije

Izvorni znanstveni članak

Dobro je poznato da se usporedno aktivni filter snage (SAPF - Shunt Active Power Filter) uvelike koristi za smanjenje harmonijske distorzije i kompenzaciju reaktivne snage u elektroenergetskim sustavima. Regulator napona sabirnice istosmjerne struje SAPF-a vrlo je važan za odličnu kvalitetu snage. U reguliranju SAPF-a, napon sabirnice istosmjerne struje regulira se konvencionalnim metodama kao što su PI i PID regulatori. Međutim, ti regulatori ne mogu dati dobre rezultate u prijelaznim i stacionarnim uvjetima. Robusni i inteligentni regulatori potrebni su za poboljšanje performansi SAPF-a. U ovom radu, sustav neizržite logike intervala tipa-2 (T2FLS) koji ne zahtijeva matematički model kao kontrolni sustav preferira se za reguliranje napona sabirnice istosmjerne struje SAPF-a i uspoređuje sa sustavom neizržite logike tipa-1 (T1FLS). Konstruirane su i simulirane strukture SAPF-a s oba regulatora primjenom MATLAB /Simulink okruženja. Rezultati simulacije su pokazali da SAPF struktura s predloženim regulatorom ima bolje karakteristike od T1FLS-a u odnosu na fiksni napon sabirnice istosmjerne struje, ukupno harmoničko izobličenje i kvalitetu snage.

Ključne riječi: kompenzacija reaktivne snage; kvaliteta snage; regulator neizržite logike intervala tipa-2; usporedno aktivni filter snage

1 Introduction

In recent years, electricity market has shown a great change in the world. Limited natural resources and increasing energy demand are some of the most important reasons for this change. The new investment is required to meet the growing energy demand. However, new power plants and transmission lines will result in significant costs and environmental problems. Because of these reasons, it has become imperative for the existing generation and transmission systems to use the most efficient way. Nowadays, increase in the use of power electronics based devices and non-linear loads cause many serious problems such as the harmonic distortion and power quality [1, 2]. Passive and active power filters (APFs) are often used to solve these problems. APF consisting inverter, DC bus and an output filter are preferred because of their superior characteristics such as harmonic and reactive power compensation [1÷3]. The main feature of APF is to eliminate the harmonic currents drawn from the nonlinear loads using power electronics technologies. Also, many studies have been carried out in order to enhance dynamic performance of APF. In literature, intelligent control systems are developed to control DC bus voltage of APF and many controller techniques are proposed such as PI controller, PID controller, sliding mode controller, H_∞ controller, adaptive controller and etc. [4÷14].

The fuzzy logic concept was firstly introduced by L. Zadeh in 1965 [15]. After this date, Fuzzy logic systems have been designed and used for many industrial applications. Moreover, since most of the systems and

processes are characterized by uncertainties and nonlinearities, many fuzzy control methods have been successfully implemented in many engineering problems. However, type-1 fuzzy logic system (T1FLS) has some limitations such as expressing the uncertainties and nonlinearities. The membership grade for each input value in T1FLS that has a crisp value causes limitations. The concept of type-2 fuzzy logic system (T2FLS) is a generalization of ordinary fuzzy sets and was firstly introduced by L. Zadeh. The main feature of T2FLSs is the Footprint of Uncertainty (FOU) describing the uncertainties and nonlinearities. Many studies have shown that T2FLS are much more robust to cope with uncertainties and nonlinearities compared to T1FLS [15-20]. In this paper, T2FLS is applied to a SAPF to control DC bus voltage and to reduce harmonic distortion. The use of T2FLS does not only provide better performance of DC bus voltage, but also enhances power quality. In the paper, mathematical model of SAPF is derived in section 2. Then, the design of proposed controller is presented in section 3. For the performance of the controllers, simulation results obtained from both controllers are given in section 4. The effectiveness of T2FLS is given in section 5.

2 Mathematical Model of Shunt Active Power Filter

The shunt compensation systems consist of three-phase voltage sources, nonlinear load and a shunt connected power system as shown in Fig. 1. Many control methods are used in the control of three-phase SAPF.

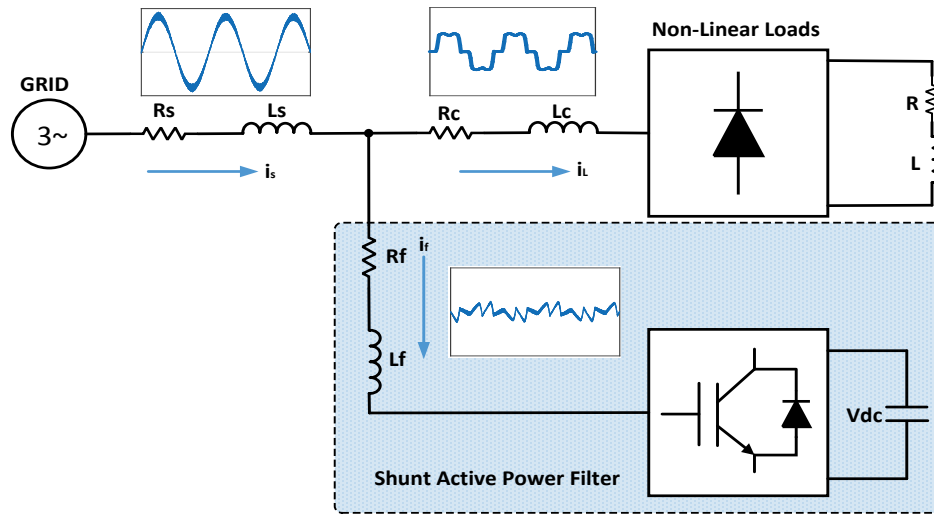

Figure 1 Configuration of SAPF

Instantaneous reactive power theory was proposed by H. Akagi in 1983 [4]. This method is known as *p-q* theory.

The *p-q* theory consists of an algebraic transformation of the three-phase voltages and currents in the *abc* coordinates to the *αβ0* coordinates. Instantaneous power components are calculated from *αβ* components. The object of *αβ0* transformation is to remove the zero-sequence components from the balanced system and reduce the number of variables. The three-phase instantaneous components are calculated by this theory based on instantaneous reactive power theory. Three-phase voltage and current transformations are calculated according to the Clark transformation and its inverse transformation. The following equations can be obtained:

$$\begin{bmatrix} v_a \\ v_b \\ v_c \end{bmatrix} = \sqrt{\frac{2}{3}} \begin{bmatrix} 1/\sqrt{2} & 1 & 0 \\ 1/\sqrt{2} & -1/2 & \sqrt{3}/2 \\ 1/\sqrt{2} & -1/2 & -\sqrt{3}/2 \end{bmatrix} \begin{bmatrix} v_0 \\ v_\alpha \\ v_\beta \end{bmatrix} \tag{1}$$

$$\begin{bmatrix} V_0 \\ V_\alpha \\ V_\beta \end{bmatrix} = \sqrt{\frac{2}{3}} \begin{bmatrix} 1/\sqrt{2} & 1/\sqrt{2} & 1/\sqrt{2} \\ 1 & -1/2 & -1/2 \\ 0 & \sqrt{3}/2 & -\sqrt{3}/2 \end{bmatrix} \begin{bmatrix} V_a \\ V_b \\ V_c \end{bmatrix} \tag{2}$$

$$\begin{bmatrix} i_a \\ i_b \\ i_c \end{bmatrix} = \sqrt{\frac{2}{3}} \begin{bmatrix} 1/\sqrt{2} & 1 & 0 \\ 1/\sqrt{2} & -1/2 & \sqrt{3}/2 \\ 1/\sqrt{2} & -1/2 & -\sqrt{3}/2 \end{bmatrix} \begin{bmatrix} i_0 \\ i_\alpha \\ i_\beta \end{bmatrix} \tag{3}$$

$$\begin{bmatrix} i_0 \\ i_\alpha \\ i_\beta \end{bmatrix} = \sqrt{\frac{2}{3}} \begin{bmatrix} 1/\sqrt{2} & 1/\sqrt{2} & 1/\sqrt{2} \\ 1/\sqrt{2} & -1/2 & -1/2 \\ 0 & \sqrt{3}/2 & -\sqrt{3}/2 \end{bmatrix} \begin{bmatrix} i_a \\ i_b \\ i_c \end{bmatrix} \tag{4}$$

The instantaneous real (*p*) and reactive (*q*) powers can be explained as follows:

$$p = V_\alpha i_\alpha + V_\beta i_\beta \tag{5}$$

$$q = -V_\beta i_\alpha + V_\alpha i_\beta \tag{6}$$

The instantaneous real power and reactive power related to *αβ*-axis currents and voltages can be written as:

$$\begin{bmatrix} p \\ q \end{bmatrix} = \begin{bmatrix} v_\alpha & v_\beta \\ -v_\beta & v_\alpha \end{bmatrix} \begin{bmatrix} i_\alpha \\ i_\beta \end{bmatrix} \tag{7}$$

In *p-q* control theory, the real and reactive powers can be selected independently and expressed as:

$$p = \bar{p} + \tilde{p} \tag{8}$$

$$q = \bar{q} + \tilde{q} \tag{9}$$

where, \bar{p} and \bar{q} are the mean value of the instantaneous real power and the instantaneous reactive power. \tilde{p} and \tilde{q} are the alternated values of the instantaneous real power and the instantaneous reactive power [3÷6].

$$\begin{bmatrix} i_\alpha \\ i_\beta \end{bmatrix} = \begin{bmatrix} v_\alpha & v_\beta \\ -v_\beta & v_\alpha \end{bmatrix}^{-1} \begin{bmatrix} p \\ q \end{bmatrix} \tag{10}$$

In order to compensate harmonics and reactive power, the instantaneous compensating current is expressed as follows:

$$\begin{bmatrix} i_{f\alpha} \\ i_{f\beta} \end{bmatrix} = \begin{bmatrix} v_\alpha & v_\beta \\ -v_\beta & v_\alpha \end{bmatrix}^{-1} \begin{bmatrix} -\tilde{p} \\ -q \end{bmatrix} \tag{11}$$

To obtain the reference compensating currents in the *abc* coordinates, Eq. (9) can be obtained as follows:

$$\begin{bmatrix} i_{fa}}^* \\ i_{fb}^* \\ i_{fc}^* \end{bmatrix} = \sqrt{\frac{2}{3}} \begin{bmatrix} 1 & 0 \\ -1/2 & \sqrt{3}/2 \\ -1/2 & -\sqrt{3}/2 \end{bmatrix} \begin{bmatrix} i_{f\alpha}^* \\ i_{f\beta}^* \end{bmatrix} \tag{12}$$

3 Design of Interval Type-2 Fuzzy Logic Controller

T2FLSs are considered as generalized form of T1FLS and T1FLSs are called ordinary fuzzy sets. T2FLS cannot be simply defined mathematically as T1FLS because of

its additional dimension [16, 17]. The membership degree of a T2FLS membership function is a type-1 fuzzy set but all non-zero membership degrees always equal one. The input variable (x) of T1FLS is called primary variable for T2FLS. The membership function of the primary variable can be called primary membership function $\mu(x)$ for T2FLS. T1FLS (A) has a primary variable, a primary membership function and a membership grade while a T2FLS (\tilde{A}) includes uncountable number of primary membership function and membership degree. The secondary variable (u) is an element of a primary membership [17÷20]. The secondary grade is the weight of each secondary variable. A type-2 fuzzy set denoted by \tilde{A} , is characterized as:

$$\tilde{A} = ((x, u), \mu_{\tilde{A}}(x, u)) \mid \forall x \in X \tag{13}$$

where, X is the domain of the input variable, x is the value of the input variable, u is the primary grade of a type-2 fuzzy set and J_x is the primary membership of a type-2 fuzzy set, $\mu_{\tilde{A}}(x, u)$ is the secondary membership function [17÷20]. A T2FLS can be expressed for a continuous universe of discourse as follows:

$$\tilde{A} = \int_{x \in X} \int_{u \in J_x} \mu_{\tilde{A}}(x, u) / (x, u) \tag{14}$$

where, $J_x \subseteq [0, 1]$ and \int denotes the union over all admissible x and u . \tilde{A} can be re-expressed as:

$$\tilde{A} = (x, \mu_{\tilde{A}}(x)) \mid \forall x \in X \tag{15}$$

$$\tilde{A} = \int_{x \in X} \left[\int_{u \in J_x} f_x(u) / u \right] / x \quad J_x \subseteq [0, 1] \tag{16}$$

$$\tilde{A} = \sum_{i=1}^N \left[\sum_{u \in J_{x_i}} f_{x_i}(u) / u \right] / x_i \tag{17}$$

The union of all primary memberships is called Footprint of Uncertainty (FOU). In addition, the FOU is the superiority of a T2FLS and is expressed as [16÷20]:

$$FOU(\tilde{A}) = \bigcup_{x \in X} J_x \tag{18}$$

As shown in Fig. 2, T1FLS has a crisp membership degree whereas T2FLS has uncountable number of membership degrees in an interval. T2FLS can be described in terms of Lower Membership Function (LMF) and Upper Membership function (UMF) where lower and upper bounds for footprint of the uncertainty can be named LMF of type-2 fuzzy set and UMF of type-2 fuzzy set. Moreover, a T2FLS can be considered by the collection of a LMF and UMF. T2FLS consists of five main parts such as fuzzifier, fuzzy rule base, inference engine, type-reducer and defuzzifier as shown in Fig. 2.

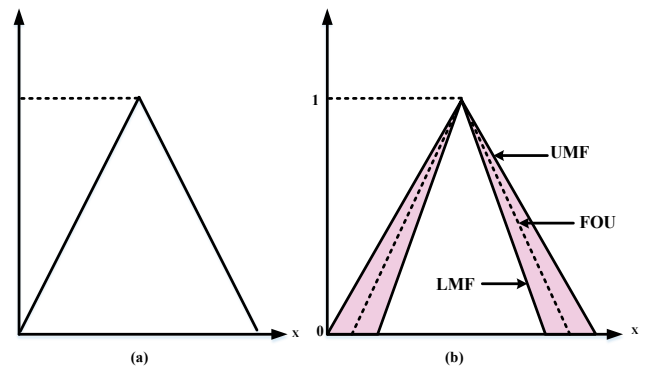

Figure 2 Triangular fuzzy sets a) Type-1 b) Type-2

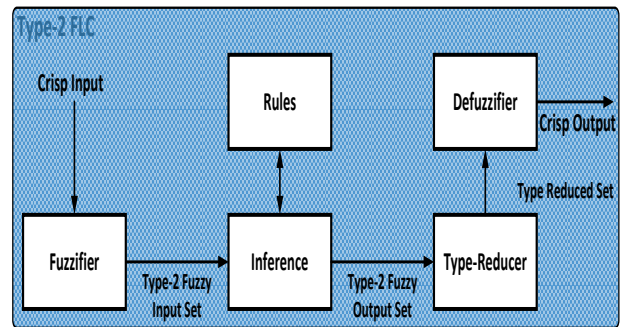

Figure 3 Block diagram of interval type-2 fuzzy logic system

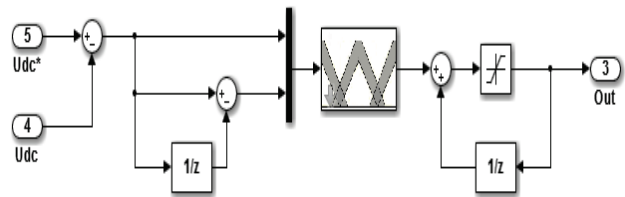

Figure 4 Simulink model of T2FLS

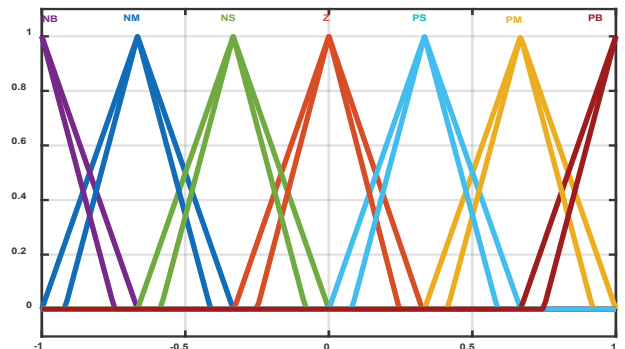

Figure 5 Membership functions for inputs and output

T2FLS has an additional part that is called type-reducer, while T1FLS does not have a type-reducer. Type-reducer is necessary for the T2FLS because defuzzifier block can operate by using the type-1 information, so type-2 information has to be converted to type-1 information before the defuzzifier block [18÷20]. The output of the type-reducer block is called type-reduced set and then defuzzifier uses the type-reduced set for defuzzification process. A simple block diagram of an IT2-FLS which is special case of T2FLSs can be seen in Fig. 3.

PI and PID controllers are usually used to control the DC bus voltage of SAPF. However, these controllers are sufficient because of their many disadvantages. As shown

in Fig. 4, the designed T2FLS has two inputs and a single output. Also, An anti wind-up integrator is used to enhance tracking ability of T2FLS in transient and steady states.

Table 1 Fuzzy rule table

$\begin{matrix} de \\ e \end{matrix}$	NB	NM	NS	Z	PS	PM	PB
NB	NB	NB	NB	NB	NM	NS	Z
NM	NB	NB	NM	NM	NS	Z	PS
NS	NB	NM	NS	NS	Z	PS	PM
Z	NB	NM	NS	Z	PS	PM	PB
PS	NM	NS	Z	PS	PS	PM	PB
PM	NS	Z	PS	PM	PM	PB	PB
PB	Z	PS	PM	PB	PB	PB	PB

T2FLS is proposed to control the DC bus voltage of SAPF in order to obtain good power quality. The proposed controller is designed and applied to the SAPF simulink model. The error of DC bus voltage (e) and change in DC bus voltage (Δe) are chosen as the inputs and control signal (c) is considered to be an output of T2FLS as shown in Fig. 4. These inputs are normalized to obtain error $e(k)$ and its change $\Delta e(k)$ in the range of -1 to $+1$. Triangular membership functions are chosen for the inputs and the output of T2FLS. The fuzzy membership functions consist of seven fuzzy sets: Negative Big (NB), Negative Medium (NM), Negative Small (NS), Zero (Z), Positive Small (PS), Positive Medium (PM) and Positive Big (PB). The rule base of T2FLS is given in Tab. 1.

4 Simulation results

To verify the effectiveness of SAPF with the proposed controller, simulation studies are realized at MATLAB/Simulink environment. Electrical parameters of SAPF used in simulation studies are given Tab. 2. Two scenarios for steady state and transient state conditions are considered in simulation studies and Matlab/Simulink Model of SAPF is given in Fig. 6.

In these scenarios, the same conditions are provided for T1FLS and T2FLS. The first scenario is carried out under fixed load in order to test the performance of SAPF structure with two controllers. Waveform obtained from

both controllers is given in Fig. 7. When the switch is on at $t = 0.3$ s, the grid current has a sinusoidal form and is in phase with grid voltage. As can be seen, the grid current has a significant amount of harmonics before compensation and THD value 24.94 %. After compensation, THD values of grid current are 1.40 % and 1.48 % for T2FLS and T1FLS, respectively. Also, Fig. 7 shows DC bus voltages of both controllers. As shown in Fig. 7, DC bus voltage responses have no oscillation and are regulated to the reference DC voltage. According to this scenario, T2FLS has better dynamic performance than T1FLS with regard to THD, fixed DC bus voltage and power quality.

Table 2 Electrical parameters of SAPF

Parameters	Values
Grid Voltage (V_s)	100 V_{rms}
DC bus Capacitor (C)	3.3 mF
Source and Filter impedances (R_s, L_s, R_f, L_f)	0.1 m Ω , 0.1 mH
Diode rectifier load (R, L)	15 mH, 20 Ω
DC bus voltage	220 V
Sampling Time	50e-6

The second scenario is carried out under the nonlinear load change in order to indicate the performance of SAPF with two controllers. For this scenario, the loads of diode rectifier are changed. Fig. 8(a) shows the waveforms of SAPF based on T2FLS during load change. When the load is applied at $t = 0.5$ s, DC bus voltage obtained from proposed controller drops from 220 V to 216.5 V and it reaches reference DC bus value after 0.0329 s. Besides, Fig. 8(a) shows that the grid current is sinusoidal and in phase with grid voltage. Fig. 8(b) shows the waveforms of SAPF based on T1FLS during load change. The waveforms of SAPF based on T1FLS are given in Fig. 8(b) during load change. When the load is applied at $t = 0.5$ s, DC bus voltage obtained from T1FLS drops from 220 V to 213 V and it reaches reference DC bus value after 0.0425 s. Besides, Fig. 8(b) shows that the grid current is sinusoidal and in phase with grid voltage. According to this scenario, proposed controller designed for SAPF has superior features in term of the control of DC bus voltage and power quality.

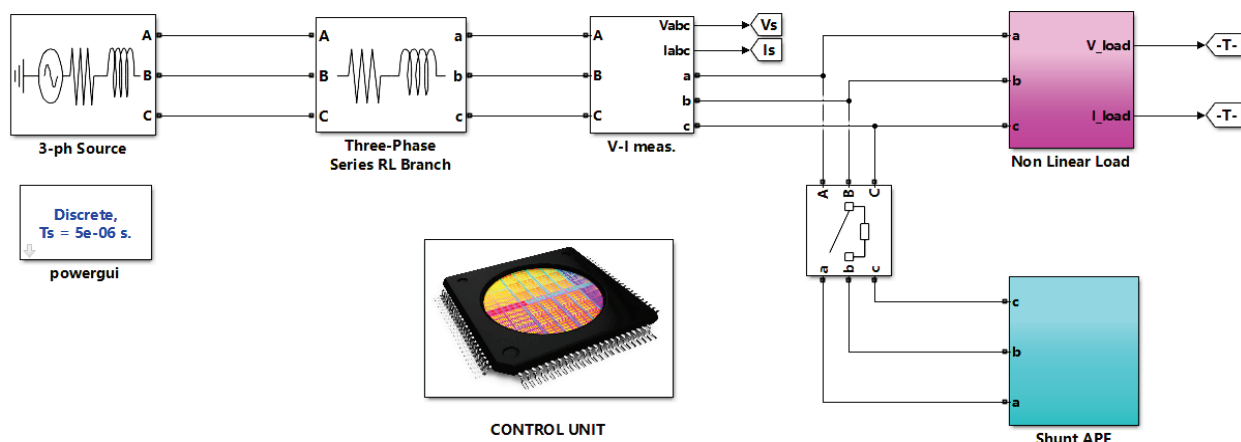
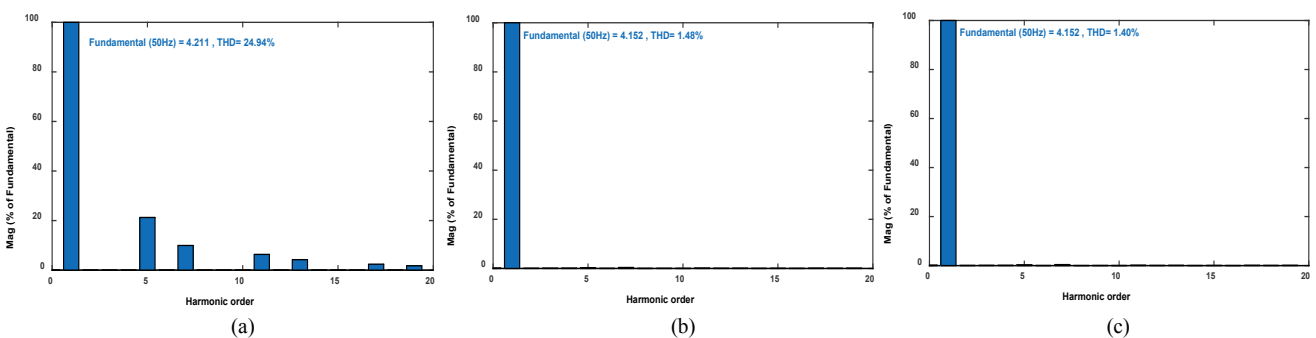
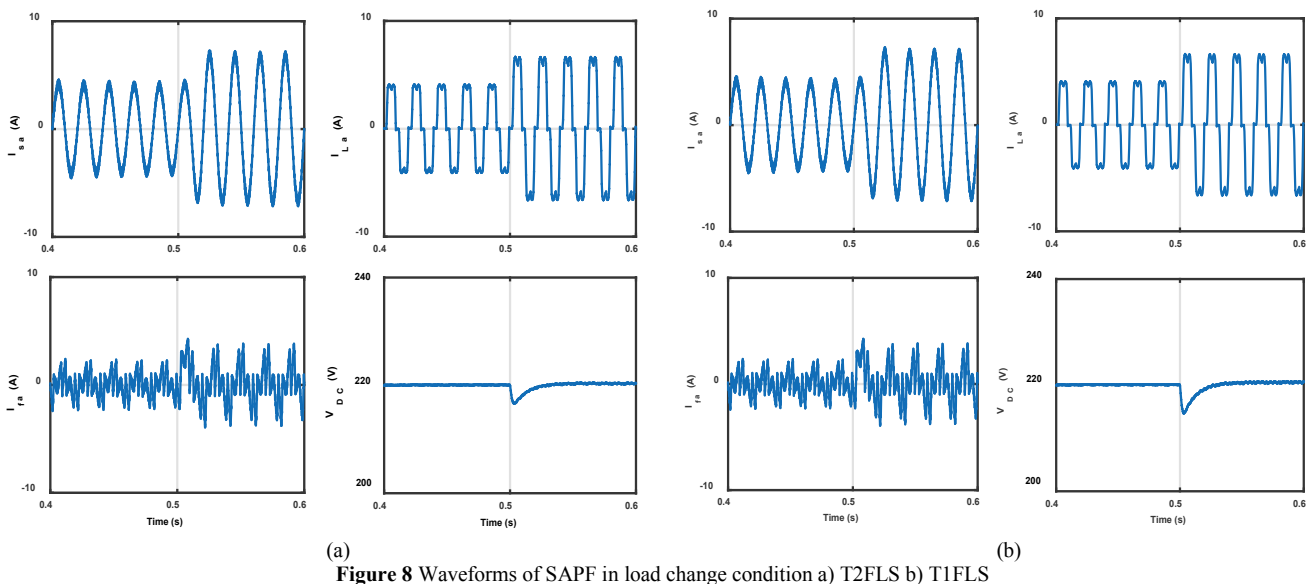
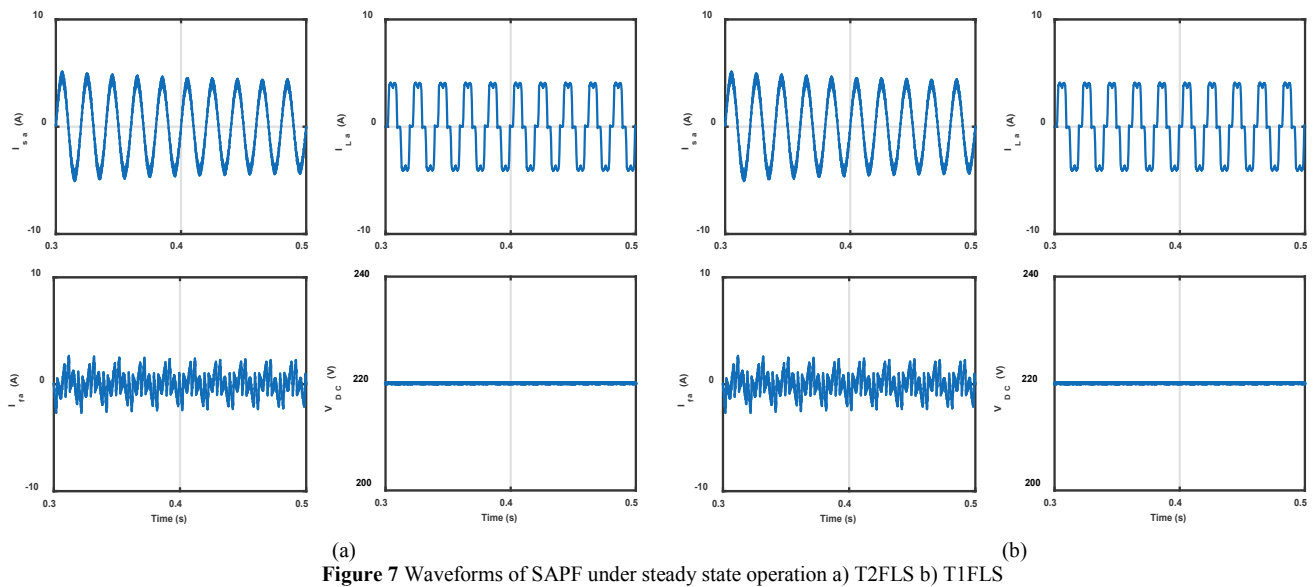

Figure 6 Matlab/Simulink Model of SAPF



Also, THD values of SAPF obtained from both controllers are given in Fig. 9. These values show that SAPF with T2FLS has good power quality.

5 Conclusions

It is well-known that SAPFs are commonly used in power distribution systems for improving power quality. In this paper, T1FLS and T2FLS are designed to control the DC bus voltage of shunt active power filter in Matlab/Simulink environment. These controllers have

been compared in many ways such as THD, power quality, the controllability of DC bus voltage. Several scenarios have been carried out in order to examine the performance of the controllers under transient and steady state conditions. Simulation results show that THD values of the grid current obtained from both controllers under compensation condition are below 5 % and these values are suitable limit specified by the IEEE 519 standards. According to simulation results, it is also observed that the T2FLS has superior dynamic performance when compared to the T1FLS in terms of

DC bus voltage regulation, harmonics reduction and reactive power compensation.

6 References

- [1] Bhim, S.; Kamal, A. H.; Ambrish, C. A review of active filter for power quality improvements. // IEEE Transactions on Industrial Electronics. 46, 5(1999), pp. 960-970. <https://doi.org/10.1109/41.793345>
- [2] Murat, K.; Engin, O. Harmonic and reactive power compensation with shunt active power filter under non-ideal mains voltage. // Electric Power Systems Research. 74, (2005), pp. 363-370. <https://doi.org/10.1016/j.epr.2004.10.014>
- [3] Jain, S. K.; Agarwal, P.; Gupta, H. O. Design simulation and experimental investigations on a shunt active power filter for harmonics and reactive power compensation. // Electric Power Components and Systems. 31, 7(2003), pp. 671-692. <https://doi.org/10.1080/15325000390203674>
- [4] Akagi, H.; Kanazawa, Y.; Nabae, A. Generalized Theory of the Instantaneous Reactive Power in Three-phase Circuits. // Proceedings of IEEJ International Power Electronics Conference, IPEC-Tokyo, 1983, pp. 1375-1386.
- [5] Hirofumi, A.; Edson, H. W.; Mauricio, A. Instantaneous power theory and applications to power conditioning. // IEEE-press, 2007.
- [6] Czarnecki, L. S. Instantaneous reactive power p-q theory and power properties of three-phase systems. // IEEE Transactions on Power. 21, 1(2006), pp. 362-367. <https://doi.org/10.1109/TPWRD.2005.852348>
- [7] Deng, L.; Fei, J.; Cai, C. Global Fast Terminal Sliding Mode Control For An Active Power Filter Based On A Backstepping Design. // Revue Roumaine des Sciences Techniques, Série Électrotechnique et Énergétique. // 61, 3(2016), pp. 293-298.
- [8] Jain, S. K.; Agrawal, P.; Gupta, H. O. Fuzzy logic controlled shunt active power filter for power quality improvement. // IEEE Proceedings-Electrical Power Applications. 149, 5(2002), pp. 317-328.
- [9] Masjedi, S.; Ahmadi, M.; Pashajavid, E. Improved shunt APF based on using adaptive RBF neural network and modified hysteresis current control. // International Symposium on Power Electronics, Electrical Drives, Automation and Motion, 2010, pp. 216-220. <https://doi.org/10.1109/SPEEDAM.2010.5545054>
- [10] Saetio, S.; Torrey, D. A.; Devaraj, R. The Design and Implementation of a Three-Phase Active Power Filter Based on Sliding Mode Control. // IEEE Transactions on Industry Applications. 31, 5 (1995), pp. 993-1000. <https://doi.org/10.1109/28.464511>
- [11] Hamoudi, F.; Chaghi, A.; Adli, M.; Amimeur, H. A sliding mode control for four-wire shunt active filter. // Journal of Electrical Engineering. 62, 5 (2011), pp. 267-273. <https://doi.org/10.2478/v10187-011-0042-y>
- [12] Mikkili, S.; Panda, A. K. Real-time implementation of PI and fuzzy logic controllers based shunt active filter control strategies for power quality improvement. // International Journal of Electrical Power and Energy Systems. 43, 1(2012), pp. 1114-1126. <https://doi.org/10.1016/j.ijepes.2012.06.045>
- [13] Trinh, Q. N.; Lee, H. H. An advanced current control strategy for three-phase shunt active power filters. // IEEE Transactions on Industrial Electronics. 60, 12(2013), pp. 5400-5410. <https://doi.org/10.1109/TIE.2012.2229677>
- [14] Jiang, S.; Cui, G.; Li, C. Design of H_∞ robust control for single-phase shunt active power filter. // 7th World Congress on Intelligent Control and Automation, 2008.
- [15] Zadeh, L. A. Fuzzy sets. // Information and Control. 8, 3(1965), pp. 338-353. [https://doi.org/10.1016/S0019-9958\(65\)90241-X](https://doi.org/10.1016/S0019-9958(65)90241-X)
- [16] Liang, Q.; Mendel, J. M. Interval type-2 fuzzy logic systems: theory and design. // IEEE Transactions on Fuzzy Systems. 8, 5(2000), pp. 535-550. <https://doi.org/10.1109/91.873577>
- [17] Kumbasar, T. A Simple Design Method for Interval Type-2 Fuzzy PID Controllers. // Soft Computing. 18, 7(2014), pp. 1293-1304. <https://doi.org/10.1007/s00500-013-1144-1>
- [18] Suresh, D.; Singh, S. P. Type-2 Fuzzy Logic Controlled Three-level Shunt Active Power Filter for Power Quality Improvement. // Electric Power Components and Systems. 44, 8(2016), pp. 873-882. <https://doi.org/10.1080/15325008.2016.1138158>
- [19] Karnik, N. N.; Mendel, J. M.; Liang, Q. Type-2 fuzzy logic systems. // IEEE Transactions on Fuzzy Systems. 7, 6(1999), pp. 643-658. <https://doi.org/10.1109/91.811231>
- [20] Mikkili, S.; Panda, A. K. Types-1 and -2 fuzzy logic controllers-based shunt active filter Id-Iq control strategy with different fuzzy membership functions for power quality improvement using RTDS hardware. // IET Power Electronics. 6, 4(2013), pp. 818-833. <https://doi.org/10.1049/iet-pel.2012.0613>

Authors' addresses

Hakan Acikgoz

Electrical Science,
Kilis 7 Aralik University
Kilis, 79000, Turkey
E-mail: hakanacikgoz@kilis.edu.tr

O. Fatih Kececioglu

Dept. of Electrical and Electronics Engineering
Kahramanmaraş Sutcu Imam University
Kahramanmaraş, 46050, Turkey
E-mail: fkececioglu@ksu.edu.tr

Ahmet Gani

Dept. of Electrical and Electronics Engineering
Kahramanmaraş Sutcu Imam University
Kahramanmaraş, 46050, Turkey
E-mail: agani@ksu.edu.tr

Mustafa Tekin

Dept. of Electrical and Electronics Engineering
Kahramanmaraş Sutcu Imam University
Kahramanmaraş, 46050, Turkey
E-mail: mustafatekin@ksu.edu.tr

Mustafa Sekkeli

Dept. of Electrical and Electronics Engineering
Kahramanmaraş Sutcu Imam University
Kahramanmaraş, 46050, Turkey
E-mail: msekkeli@ksu.edu.tr