

# DIJAGNOSTIČKI PREGLED RASPADA ELEKTROENERGETSKOG SUSTAVA NA OTOKU RODOSU DIAGNOSTIC REVIEW OF A BLACKOUT IN RHODES

Prof Papazoglou, Th. M., PhD, Prof Papazoglou, M. T., PhD,  
The Technological Education Institute of Crete,  
P.P. Box 1939, Iraklio, Crete, Greece

Prof Thalassinakis, E. J., PhD, Prof Tsihlikis, Ch., PhD, Prof  
Hatziargyriou, N. D., PhD, The Greek Power Public Corporation,  
The testing Research and Standard Center – DEH S.A.,  
32 Halkokondili Street, 10432 Athens, Grece

U radu se daje tehnička analiza jednog incidenta koji se dogodio 21. ožujka 2007. godine u 00:50 sati u noći i doveo do dvosatnog potpunog raspada elektroenergetskog sustava na otoku Rodosu. Analiza događanja temelji se na registriranim operativnim podacima kao i nalazima na terenu. Izvršena je tehnička analiza smetnji kako bi se utvrdili vjerojatni uzroci i čimbenici koji su pridonijeli pojavi smetnji. S obzirom da se radi o izoliranom sustavu koji je osobito je osjetljiv na poremećaje, ispitane su uloge zaštite sustava kao i kolebanja proizvodnje vjetroelektrana tijekom incidenta. Izvučeni su zaključci od praktičnog značenja i dane su preporuke korektivnih mjera koje valja provesti kako bi se u budućnosti spriječile takve smetnje.

A technical review of an incident on March 21, 2007 that began at 00:50 a.m. and led to a two-hour blackout of the island of Rhodes electric power system is presented with the complete sequence, including all the relevant registered operational data as well as the on-site field findings. A technical analysis of the disturbance was performed to determine the probable causes and factors that contributed to the duration of the disturbance. Since the system is an isolated one, it is particularly vulnerable to perturbations. The roles of system protection and wind power generation during the incident are examined. Conclusions of practical importance are drawn, including recommendations for corrective measures to be implemented for preventing disturbances of this kind from reoccurring in the future.

**Ključne riječi:** izolirani elektroenergetski sustav, nestanak struje  
**Key words:** blackout, isolated electric power system



## 1 UVOD

Izolirani otočni elektroenergetski sustavi zanimljivi su s tehničkog stajališta jer pokazuju neke izrazite značajke. Ako je u takvim sustavima prisutan i visok stupanj proizvodnje vjetroelektrana, javlja se u određenim okolnostima veća osjetljivost na pogonske poremećaje.

Elektroenergetski sustav grčkog otoka Rodosa izolirani je sustav s ukupno 234 MW instaliranog kapaciteta termoelektrana (5 dizelskih, 2 parne i 4 plinske turbine) te 15 MW instalirane snage u vjetroelektranama. Međutim, zbog nekih tehničkih problema i karakteristika termoelektrana, stvarna snaga termoelektrana iznosi tek približno 192 MW. Godine 2006. proizvodnja u satu vršnog opterećenja iznosila je 192,6 MWh. To znači da sustav nije uvijek imao na raspolaganju rezervnu snagu.

U ovom se članku istražuje incident poremećaja sustava 21. ožujka 2007. godine koji je započeo u 00:50 sati u noći i doveo do dvosatnog raspada elektroenergetskog sustava na otoku Rodosu.

U vrijeme neposredno prije incidenta u pogonu su bili dva parna bloka (ATM 1 i ATM 2), svaki opterećen s 10 MW (rotirajuća rezerva svakog agregata 2 MW), dva dizelska bloka (D1 i D3): s opterećenjem 6 MW (rotirajuća rezerva 5 MW), ostala proizvodnja s 12 MW (rotirajuća rezerva 5 MW) te 12 MW vjetroelektrana. Vremenski uvjeti bili su loši i jamačno su odigrali određenu ulogu na početku incidenta. Na slici 1 dana je jednopolna shema sustava.

Smetnje u sustavu započele su asimetričnim trofaznim kratkim spojem bez zemljospoja. Taj je kvar uspješno uklonjen. Međutim, zbog nestabilnosti uzrokovane zaštitnim mehanizmima sustav se nije oporavio već je postupno gubio proizvodnju i izazivao značajnu redukciju opterećenja što je, nakon 2 minute i 45 sekundi od uklanjanja prvog kvara, konačno dovelo do potpunog raspada elektroenergetskog sustava.

## 1 INTRODUCTION

Isolated island power systems are of interest from the technical point of view because they exhibit notable characteristics. For example, when there is a high penetration of wind generation, there is greater vulnerability to operation perturbations under certain conditions.

The electric power system of the Greek island of Rhodes is an isolated system with 234 MW installed capacity of thermal plants (5 diesel, 2 steam and 4 gas turbines) plus 15 MW wind generation. However, due to some technical problems and the characteristics of the thermal generating plant, the actual thermal generation capacity is only about 192 MW. In the year 2006, the mean average hourly generation peaked at 192,6 MWh. This means that the system did not have appreciable reserve power at all times.

This article examines the system disturbance incident of March 21, 2007 that began at 00:50 a.m. and led to a two-hour blackout of the Rhodes Island Electrical Power System.

At the time just before the incident, the system was operating with 2 steam units (ATM 1, and ATM 2) with 10 MW production each (a spinning reserve of 2 MW each) and 2 diesel units (D1, and D3): one producing 6 MW (with a 5 MW spinning reserve) and the other generating 12 MW (with a 5 MW spinning reserve). At the same time, wind generation was 12 MW. A one-line diagram of the system is shown in Figure 1. The weather conditions were severe and played a definite role at the start of the incident.

The system disturbance began with an asymmetrical three-phase fault, not involving ground. This fault was successfully cleared. However, due to instabilities triggered by the protective mechanisms, the system never really recovered, gradually losing generation and causing significant load shedding, which finally led to a complete blackout lasting 2 minutes and 45 seconds after the initial fault had been cleared.

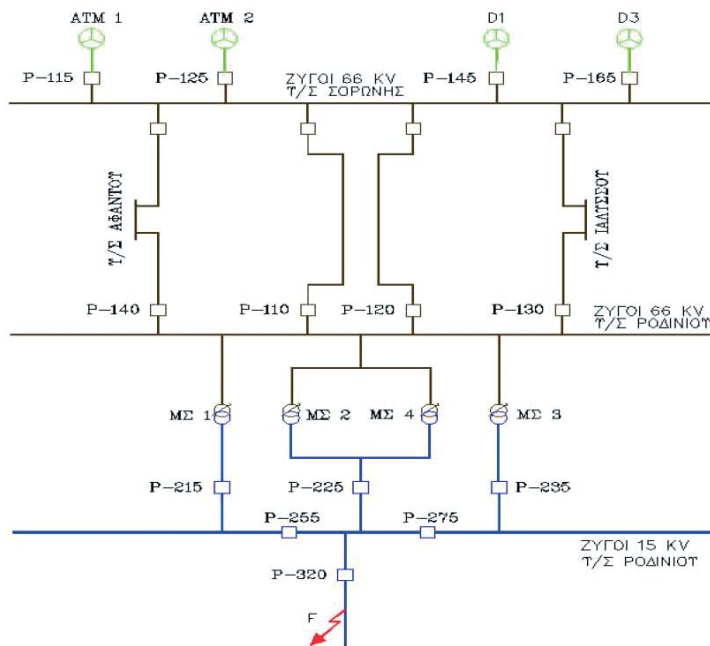

**Slika 1**  
 Jednopolna shema sustava na početku smetnje  
 Figure 1  
 One-line diagram of the system at the start of the fault

Kvar se dogodio na trafostanici Rhodini na distribucijskom vodu napajanom putem prekidača P-320 od 15 kV sabirnice, kako je prikazano na slici 1. Nakon gubljenja struje iz voda aktivirana je zaštita i otpušteni su prekidači P-320, P-255 i P-225. Zbog kvara je izgorio drveni stup distribucijskog voda te se kasnije morao zamijeniti. Vrijeme je bilo vrlo loše u trenutku kvara, pri čemu je jak vjetar raspršivao kapljice morske vode po izolatorima vodova, što je intenziviralo površinsko pražnjenje. Naknadnom analizom pronađen je srednji fazni vodič (u vodoravnom rasporedu od 3 faza) prekinut na jednom drvenom stupu. Isto se dogodilo s drugim stupom istog voda gdje su, osim prekinutog srednjeg vodiča, također bili razbijeni porculanski izolatori, najvjerojatnije kao posljedica struje zemljospoja. Taj je početni kvar konačno uklonjen oko 13 sekundi nakon što se dogodio. Međutim, 19 sekundi nakon uklanjanja kvara ispao je parni blok #1 a potom, 2 minute i 45 sekundi nakon uklanjanja kvara, i parni blok #2, što je rezultiralo raspadom elektroenergetskog sustava.

The fault occurred at the Rhodini substation on the distribution line fed through the breaker P-320 from the 15 kV bus, as shown in Figure 1. Following the fault, protection was activated and tripped the breakers P-320, P-255 and P-225. As a result of the fault, a wooden pole of the distribution line burned and had to be replaced later. The weather was severe at the time of the fault, with strong wind spraying sea water droplets over the line insulators, thereby increasing the likelihood of a flashover. Post-mortem examination found the jumper wire for the middle phase conductor (in a horizontal arrangement of the 3 phases) cut at another wooden pole of the same distribution line. The same thing also happened to another pole of the same line where, in addition to a broken middle jumper wire, its porcelain insulators were also broken. This would most likely imply that these were the results of the fault current. This initial fault was finally cleared at about 13 sec after it happened. However, 19 sec after the fault clearance, Steam Unit #1 was lost, and 2 min and 45 sec after the fault clearance Steam Unit #2 was lost, resulting in the blackout.



## 2 ANALIZA INCIDENTA

Kako sustavu SCADA u kontrolnom centru nedostaju neke važne funkcije bilo je moguće tek samo bilježenje pogonskih podataka u realnom vremenu, dok se u mnogim slučajevima događaju značajna zakašnjenja u bilježenju podataka. Iz ispitivanja zabilježenih događaja i podataka moguće je zaključiti kako je smetnja započela asimetričnim trofaznim kratkim spojem bez zemljospoja. Ovaj zaključak temelji se na vremenskim krivuljama izmjenične struje zabilježenih digitalnim relejima prekidača P-225 i P-255 (slika 2), koji su pokazivali nepostojanje struje zemljospoja. Moglo se također zamijetiti da impedancije kvara variraju s vremenom, upućujući na električno iskrenje kao uzrok. Oscilogrami 1 i 2 (slike 3 i 4) prikazuju napone na sabirnicama 66 kV na trafostanici Rhodini, odnosno struje na prekidaču 66 kV P-110 onako kako su se i razvijali. Naknadni vremenski oscilogrami 3 i 4 (slike 5 i 6) tu oscilaciju (frekvencije 100 Hz) jasnije prikazuju. Oscilacija se održava do kraja (kao što je razvidno iz oscilograma 5 (slika 7)). To može značiti i da je automatskim regulatorima napona (AVR) potrebno podešavanje.

Iz oscilograma napona moguće je izračunati veličinu napona kao funkciju vremena, i to od nastanka kvara do potpunog pada napona, kako je prikazano na slici 8.

Tijekom smetnje zabilježene su promjene frekvencije širokog raspona. Relevantni podaci prikazani su na slici 9 na kojoj je vidljiva minimalna frekvencija od 47,7 Hz (2 s nakon početka smetnje) i maksimalna frekvencija od 54 Hz (16 s nakon početka smetnje).

## 2 INCIDENT ANALYSIS

At the outset, one should note that the SCADA at the Control Center leaves important functionalities to be desired. As a result, real-time registration of operation is only partially possible, while in many cases significant time delays occur in data registration. From examination of the registered events and data, one is able to see the following. The fault began as an asymmetrical three-phase fault, not involving the ground. This was evident from the time alternating current curves registered by the digital relays of the P-225 and

P-255 (Figure 2) breakers, which showed zero earth current. It could also be observed that the fault impedances varied randomly with time, suggesting that the electric-arcing of varying spans was the cause. Oscillograms 1 and 2 (Figures 3 and 4) show the voltages at the 66 kV buses at Rhodini and the currents at the 66 kV breaker P-110, respectively. These oscillograms show oscillation developing as time progresses. Subsequent time Oscillograms 3 and 4 (Figures 5 and 6) show this (100 Hz frequency) oscillation more clearly. This oscillation is sustained to the end (as seen in Oscillogram 5 (Figure 7)). This could indicate that the automatic voltage regulators (AVR) need adjustments.

From the voltage oscillogram, one can calculate the voltage magnitude as a function of time, from the occurrence of the fault up to the voltage collapse, as shown in Figure 8.

In the course of the disturbance, wide frequency swings were registered. The respective data are shown in Figure 9. In this figure, one can see the minimum frequency of 47,7 Hz (2 s after the start of the disturbance), and the maximum frequency of 54 Hz (16 s after the start of the disturbance).

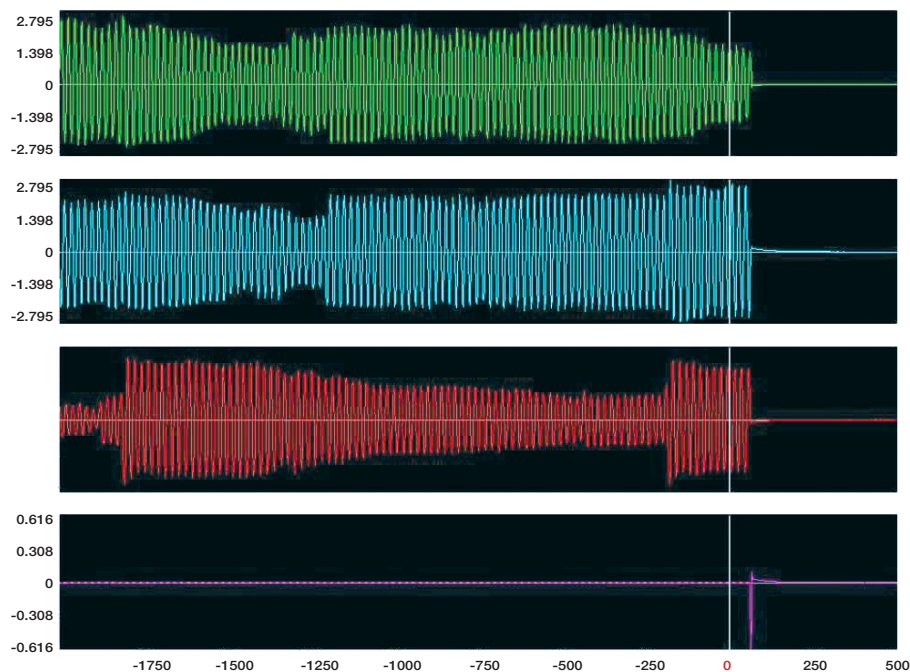

**Slika 2**  
Vremenske krivulje izmjeničnih struja faza a, b, c i uzemljenja na prekidaču P-255  
**Figure 2**  
Time curves of the alternating currents of Phases a, b, c and ground at breaker P-255

Tijekom smetnje tri su se dodatna čimbenika pokazala ključnima. Podešenja podnaponske zaštite za park vjetroelektrana kao i za pojedinačne vjetrogeneratore imala su za posljedicu ispada generatora i gubitak proizvodnje iz vjetroelektrana (24 % ukupne proizvodnje). Podešenja zaštite poduzbudnih limitera dizelskih elektrana imala su za posljedicu njihov ispad. Ispadanje 40 MW opterećenja, zbog rada automatske podfrekvencijske zaštite, rezultiralo je u preostaloj snazi od 10 MW napajanoj iz parnog bloka #2 u zadnjim trenucima neposredno prije potpunog ispada.

In the course of events, three additional factors were shown to be crucial. The under-voltage protection settings for the wind park and for the individual wind generators resulted in the loss of wind generation (24 % of the total generation). The under-excitation limiters protection settings of the diesel units resulted in the loss of those units. The shedding of 40 MW of load, due to the operation of the automatic under-frequency protection, resulted in a remaining load of 10 MW which was fed from Steam Unit #2 in the final moments just before the collapse.

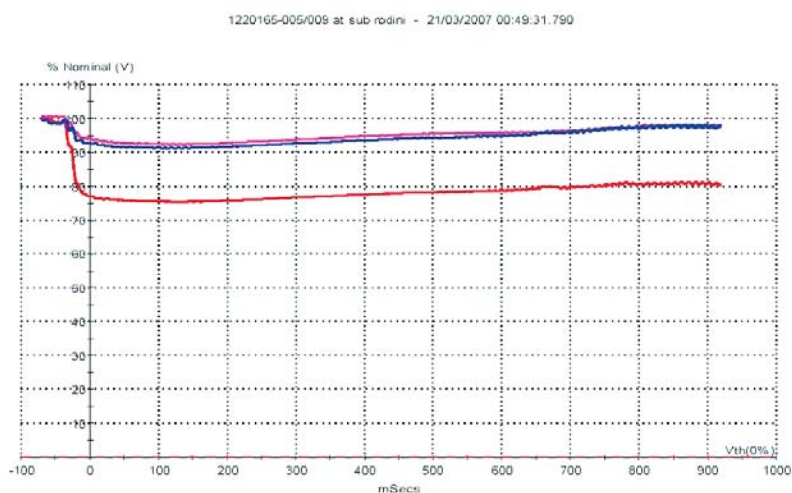

**Slika 3**  
Oscilogram 1 – Naponi na sabirnici 66 kV na trafostanici Rhodini (početak gubljenja struje iz voda)  
**Figure 3**  
Oscilogram 1 – Voltages at the 66 kV bus at Rhodini (the fault begins)

**Slika 4**  
 Oscilogram 2 –  
 Struje zabilježene  
 na prekidaču 66 kV  
 P-110 na trafostanici  
 Rhodini  
 Figure 4  
 Oscillogram 2 –  
 Currents registered at  
 66 kV Breaker P-110  
 at Rhodini

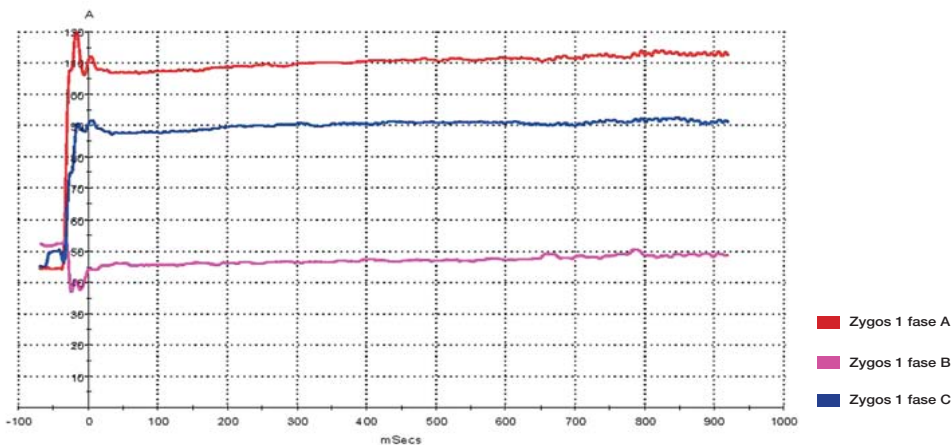

**Slika 5**  
 Oscilogram 3 – Naponi  
 na sabirnici 66 kV na  
 trafostanici Rhodini  
 Figure 5  
 Oscillogram 3 –  
 Voltages at 66 kV bus  
 at Rhodini

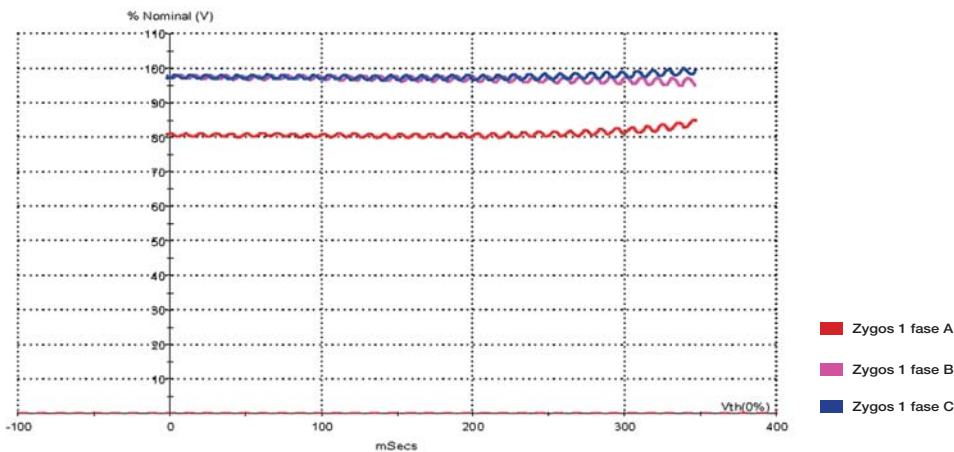

**Slika 6**  
 Oscilogram 4 – Naponi  
 na sabirnici 66 kV na  
 trafostanici Rhodini  
 Figure 6  
 Oscillogram 4 –  
 Voltages at 66 kV bus  
 at Rhodini

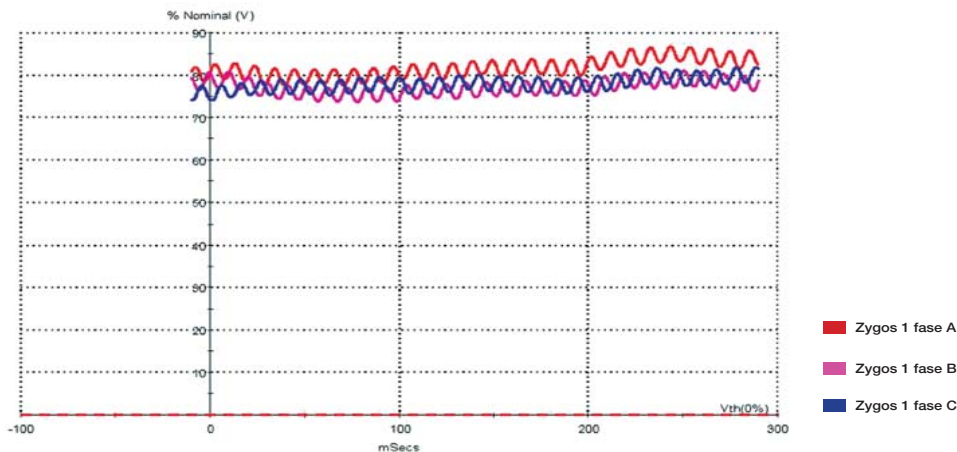

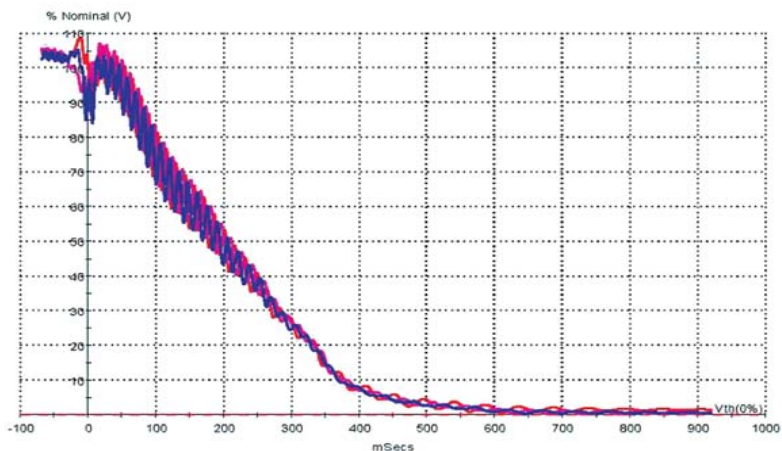

Zygos 1 fase A  
 Zygos 1 fase B  
 Zygos 1 fase C

**Slika 7**  
 Oscilogram 5 – Napon na sabirnici 66 kV na trafostanici Rhodini (nestanak struje vidljiv na kraju)

**Figure 7**  
 Oscillogram 5 – Voltage at 66 kV bus at Rhodini (blackout seen at the end)

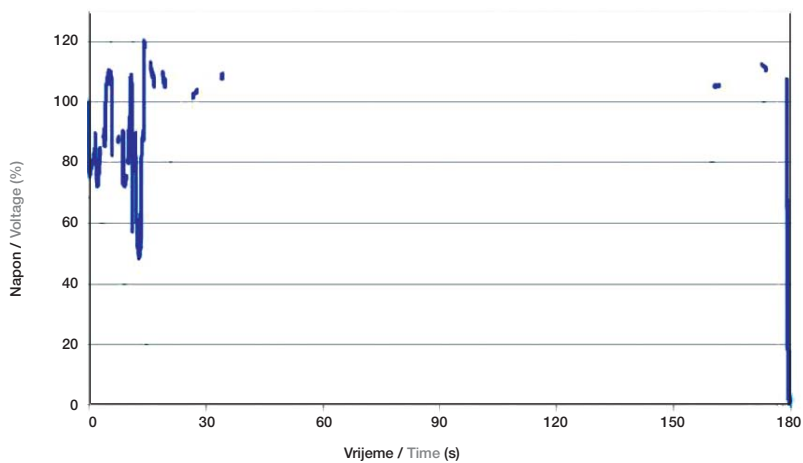

**Slika 8**  
 Varijacija napona na sabirnici 66 kV (u %) tijekom smetnje

**Figure 8**  
 66 kV bus voltage variation (in %) during the disturbance

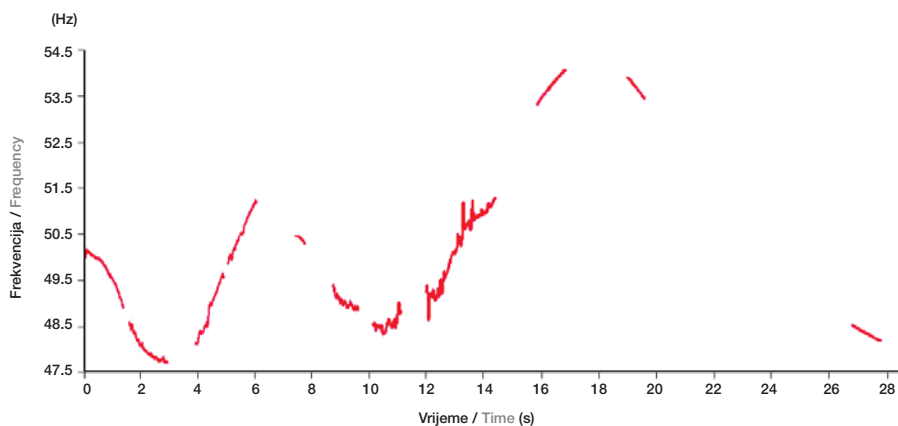

**Slika 9**  
 Trend varijacije frekvencije zabilježen tijekom smetnje

**Figure 9**  
 Frequency variation trend registered during the disturbance



### 3 ZAKLJUČCI

Elektroenergetski sustav otoka Rodosa, kao jedan izoliran sustav, osjetljiv je na smetnje. Distribucijski sustav srednjenaponskih nadzemnih vodova u blizini obale također je osjetljiv na učinke morske soli koja negativno utječe na pouzdanost izolacije.

Osjetljivost proizvodnje vjetroelektrana na kolebanja u naponu mreže kao i ukupna zaštita sustava odigrale su ključnu ulogu u razvijanju poremećaja koji je doveo do raspada elektroenergetskog sustava.

Trenutačno se razmatra nadogradnja prijenosnog sustava na otoku Rodosu sa sadašnjih 66 kV na 150 kV što bi se trebalo realizirati u naredne dvije do tri godine. Osim izgradnje prijenosne mreže, potrebno je nadograditi i sustav SCADA te sustave zaštite.

### 3 CONCLUSIONS

As an isolated system, the Rhodes Island system is vulnerable to disturbances. The MV overhead line distribution system in the vicinity of the coast is also vulnerable to the effects of sea salts that adversely affect the reliability of insulation.

The sensitivity of wind generation to voltage swings as well as the overall system protection played a critical role in the development of the perturbation which led to the blackout.

In view of the fact that the transmission system on Rhodes Island is currently being considered for an upgrade from the present 66 kV to 150 kV, scheduled for the next two-to-three years, it is important that the SCADA system is upgraded as well. The protection scheme should also be upgraded.

---

## LITERATURA / REFERENCES

- [1] Internal Incident-Report DEH, Blackout of the Rhodes EPS on 21.03.2007 (Interno izvješće o incidentu, Kolaps elektroenergetskog sustava Rodosa 21.03.2007)
  - [2] Marconato, R., Electric Power Systems, Volume 2 (Second Edition), CEI – Italian Electrotechnical Committee, Milano, 2004
- 

Uredništvo primilo rukopis:  
2007-07-25

Manuscript received on:  
2007-07-25

Prihvaćeno:  
2007-09-27

Accepted on:  
2007-09-27