

IGOR IVANKOVIĆ
HOPS
CROATIA

VLADIMIR TERZIJA
UNIVERSITY OF MANCHESTER
UNITED KINGDOM

SRDJAN SKOK
UNIVERSITY OF RIJEKAY
CROATIA

Transmission network angle stability protection based on synchrophasor data in control centre

SUMMARY

Angle stability appears in many forms in transmission network. There are small active power oscillations which do not endanger the normal operations whereas medium and large oscillations have implications on normal operations. These latter kinds of oscillations in some cases develop in out of step condition, which is dangerous disturbance with serious impact on transmission network and generating units.

Transmission network operator's challenges and obligations are to treat in the right manner angle stability issues in their network. Controlling and protecting network needs to be done in efficient way in order to disconnect disturbance quickly and prevent abnormal network operation without exporting disturbance in surrounding networks.

Synchrophasor measurements in control centre offer a platform, which responds in a new way on angle stability in transmission network. Those measurements which are collected in phasor data concentrators, which is a part of Wide Area Monitoring will be used for creating out of step protection. This is the first step to extended system to Wide Area Monitoring Protecting And Control (WAMPAC).

Paper gives progress of such project in Croatian Transmission Network Operator (HOPS). Firstly, there will be stated motives for development of new out of step protection based on synchrophasor measurements. Some feasibility aspect elaborated with emphasis on communications latency. Furthermore, designed Matlab model for transmission network and protection with small portions of simulations results and analyses presented in paper reveal potential of proposed solutions. This new protection is based on using voltage angles values from phasor data stream in phasor data concentrator.

KEYWORDS

Angle stability protection – WAMPAC system – Active power oscillations – Out of step protection – Transmission lines protection – Synchrophasor data – Control centre applications – Matlab model.

INTRODUCTION

Transmission system operator is obliged to constantly maintain angle stability. Deterioration of angle stability caused by disturbances manifests in oscillation of active power and if left unchecked out of step condition could develop [1]. Angle instability appears in time frames varying from very short (few seconds) to medium ones (few minutes). Synchrophasor based applications which run in control centres give TSOs new way of effectively handling and treating those disturbances [2]. Angle stability protection based on synchrophasor data can have alarming and protection functionality. Base for that functionality will be voltage and current synchrophasors data stream collected in control centres.

Methods for active power oscillations monitoring and protection

Both standard well known and new methods are available as a response to active power oscillations and some of them are already in use while others are only in research phase. A list of basic features of different technical solutions for advanced protection systems is presented in Table 1. Each method has mentioned main issues for usage like a real time protection application.

Table 1. Basic features of out of step protection methods.

Method	Line End Measurement	Wide Area Measurement	Independent from setting process ¹	Real time application	Remarks
Impedance based	✓	✗	✗	✓	Source impedances dependent, Study work phase
Resistance based	✓	✗	✗	✓	Study work phase
Voltage based	✓	✗	✗	✓	Source impedances dependent, Study work phase
Swing voltage/Speed acceleration criterion based	✓	✗	✗	✓	Voltage on source dependent, study work phase, system reduction (2 machines) approximation
Generator angle based	✓	✗	✓	✓	Availability of generator measurements, communication requirements
WAMPAC system	✓	✓	✓	✓	Communication requirements
Equal area based	✓	✗	✗	✗	Inertia values (H) for generators and parts of the system needed, system reduction, study work phase
Energy function based	✓	✗	✗	✗	Study work phase
Neural network based	✓	✗	✗	✗	Study work phase
Fuzzy logic/ clustering based	✓	✗	✗	✗	Study work phase

¹ Protection setting process is sensitive to network configurations.

WAMPAC systems are critically dependent on the communication equipment and potential delays. Preliminary evaluation focused on execution time for such algorithms shows that communications infrastructure time has an acceptable time delay in range of 50 ms and the delay time on server machines in control centres (<10 ms) is not a limitation for protection reactions. This means that the transfer of developed applications in a simulations environment to the real technical world is possible and will be the focus of future work.

Angle stability monitored with voltage angle data

Advanced transmission operation control in real time can be realized by angle voltage monitoring and by that manner the angle stability in 400 kV transmission grid in real time is monitored. Two machine model with phasor representation on both ends (sending and receiving) in transmission grid has been developed, Figure 1. Line loading P is defined with equation (1) where L_{line} is line reactance, sending end voltage is U_S and receiving end voltage is U_R . Angle between two phasor is φ .

$$P = \frac{U_S \cdot U_R}{X_{line}} \cdot \sin \varphi \quad (1)$$

Loading in this two machine model depends on angle φ and voltage ends U_S and U_R . Theoretically maximum line load will be at angle $\varphi=90^\circ$.

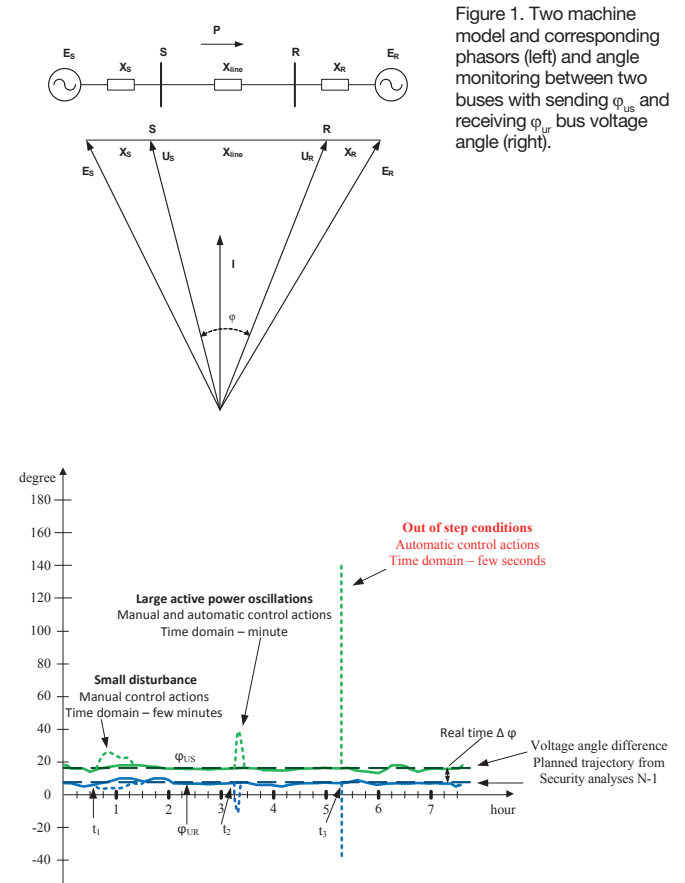

Angle difference values can be used to trace the behaviour of the transmission network. Any values deviation is noticed and appropriate control action (manual or automatic) or protection action can be launched. Figure 1 presents possible trajectory for angle difference obtained from calculations and in real time for a time span of a few hours. The Figure 1 illustratively shows different events that start at a different moment (t_1 , t_2 and t_3), have different duration and are of different severance. Angle difference deviations are presented with dashed lines. It is presumed that during disturbances appropriate control or protection action has been activated thus angle values return to levels before disturbances.

FEASIBILITY ASPECT FOR USING SYNCHROPHASOR MEASUREMENT

Croatian transmission system operator (HOPS) has operating WAM system [3] in control centre (CC) where PMUs completely cover the vital part of transmission network, Figure 2, [4].

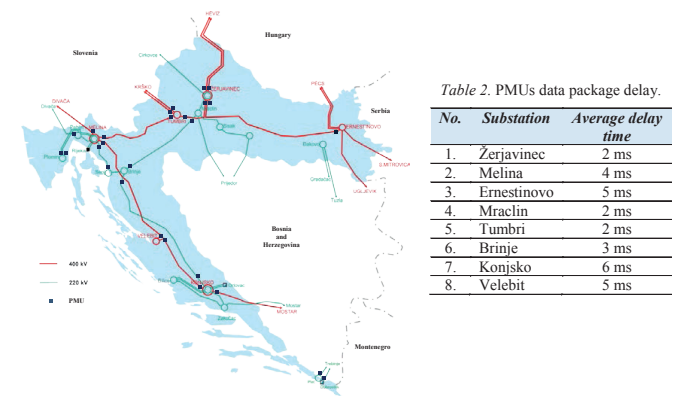

Figure 2. PMUs installation in 400 and 220 kV Croatian transmission network (left) and table with time delay values through communication infrastructure for PMUs data package (right).

Currently whole of internal 400 kV and most of 200 kV network has PMUs. PMU data collected from those devices is sufficient to get a good insight to neighboring states transmission networks and also in lower voltage transmission network (110 kV), [5].

Delay times [6] for particular connections are presented in Table 2. Those delays are fitted very well within project calculated values and are acceptable for use in wide area protection function based on synchrophasor data.

Statistical values for package delay t_{DEL} (4) were established for each PMU locations in WAM system. Table 3 has values of PMU package delays along with information about PMU type and type of communication link.

Table 3. Time delays recorded by PDC application.

No.	Substation	t_{DEL} average (ms)	PMU type	Link type
1.	Žerjavinec line Tumbri	6,0	A	SDH (64k/bit/s - 2Mbit/s)
2.	Melina line Velebit	10,0	A	SDH (64k/bit/s - 2Mbit/s)
3.	Ernestinovo line Žerjavinec	9,6	A	SDH (64k/bit/s - 2Mbit/s)
4.	Konjsko line Velebit	10,6	A	SDH (64k/bit/s - 2Mbit/s)
5.	Žerjavinec line Ernestinovo	8,5	A	SDH (64k/bit/s - 2Mbit/s)
6.	Tumbri line Melina	7,0	A	SDH (64k/bit/s - 2Mbit/s)
7.	Konjsko line Brinje	10,6	A	SDH (64k/bit/s - 2Mbit/s)
8.	Melina line Tumbri	9,9	A	SDH (64k/bit/s - 2Mbit/s)
9.	Brinje line Konjsko	9,4	A	SDH (64k/bit/s - 2Mbit/s)
10.	Brinje line Mraclin	9,3	A	SDH (64k/bit/s - 2Mbit/s)
11.	Mraclin line Brinje	5,3	A	SDH (64k/bit/s - 2Mbit/s)
12.	Velebit line Melina	7,8	A	SDH (64k/bit/s - 2Mbit/s)
13.	Velebit line Konjsko	7,7	A	SDH (64k/bit/s - 2Mbit/s)
14.	Pehlin line Divača	20,8	B	WAN (10Mbit/s - Ethernet)
15.	Melina line Divača	21,6	B	SDH (64k/bit/s - 2Mbit/s)
16.	Peruća Generator 2	23,6	B	SDH (64k/bit/s - 2Mbit/s)
17.	Peruća Generator 1	24,1	B	SDH (64k/bit/s - 2Mbit/s)
18.	Tumbri line Krško 1	22,3	B	WAN (10Mbit/s - Ethernet)
19.	Control Centre PMU 1	19,3	B	LAN
20.	Control Centre PMU 2	19,3	B	LAN

PMU packages were received by PDC algorithm with average delay within 18 to 21 ms. Additional time needed to execute triggering algorithm can be neglected.

In a system where reaction time needs to be measured in milliseconds and consequences can be severe the analyses of whole communication chain from substation to WAMPAC system and back is very important. As a prerequisite for successful functioning of the proposed advanced protection algorithm testing of time delay issues in communications infrastructure was conducted. The principal flow chart for possible WAMPAC protection function operations is presented on Figure 3. It can be seen that it is a rather complex flow chart with dedicated equipment and communications paths and devices covering the whole path from the transmission line to the WAMPAC system.

On the flow chart the upper expected time delay in all three segments of the communication chain is presented. The real time measurements conducted on a real transmission system (Croatian transmission power system) show much smaller time delays (Tables 2 and 3). Time delays measured were done separately for different communication infrastructure on a TSOs Synchronous Digital Hierarchy (SDH) optical network with LAN and WAN configurations. The measured values presented in table (Table 2) include both main and reserve paths with distance from substation to control center of up to 300 km. Results for those measurements are presented in Table 2, for substations in 400 and 220 kV high voltage network.

This means that in practice with current infrastructure it is feasible to have advanced functions because of acceptable time delays. Consequently, the advanced angle instability protection is possible to implement in real transmission networks since the communications infrastructure offers reliable path with affordable time delays.

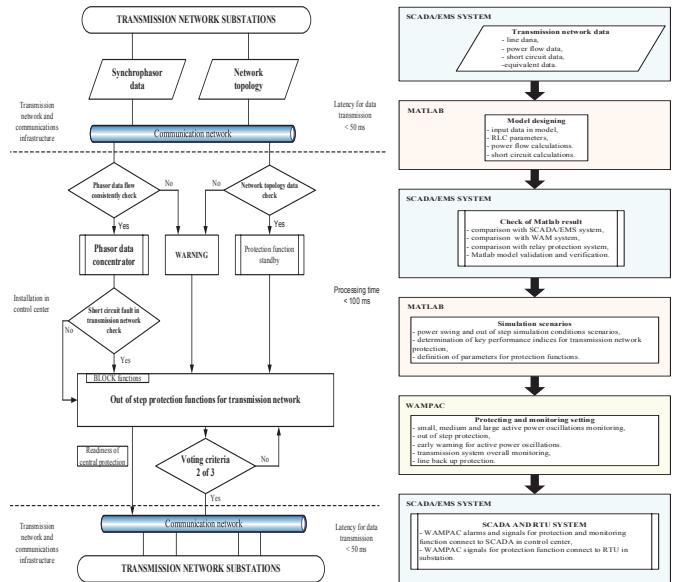

Figure 3. Principal flow chart for out-of-step protection in WAMPAC system in transmission network substations (left) and basic flow chart for designing and tuning Matlab model with protection function setting in WAMPAC system (right).

The whole process for implementing the new out of step protection function is presented in phases on the right side of Figure 3. Matlab model and its simulations possibilities were used for study work and analyses to gain parameters for settings of protection functions in WAMPAC [7], [8].

MODEL FOR TRANSMISSION NETWORK AND PROTECTION

In order to accomplish the steps required for transitioning from the currently operational WAM system installed in the control centre towards a full capability WAMPAC system, a simulation environment of detailed model of Croatian 400 kV network with PMU devices installed on all lines, Figure 4, was developed in Matlab. At this stage, only positive sequence values were used. The model fulfils the following requirements:

- Three phase transmission network model,
- Implementation of power flow functionality with basic and intermediate characteristics,
- Adaptation of a simulations time domain in milliseconds,
- Simulation of line single and three phase short circuit faults,
- Capability for creation of different system disturbances, power swing and out of step,
- Designing the system protection function for out of step and monitoring capability for power swing in transmission network,
- Designing the scope of line back up protection functions, line differential, distance, overcurrent, voltage and others.

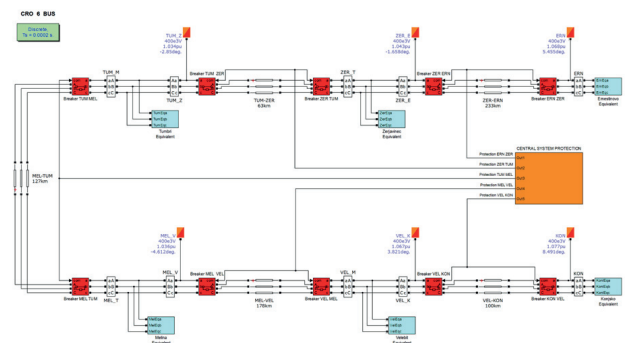

Figure 4. Matlab simulation environment with Croatian 400 kV transmission network model and central system protection in WAMPAC system in Control center.

Each 400 kV line in the model has its own three-phase voltage and current measurement module, which is a source for other monitoring and protection functions as shown in the block diagram, Figure 5. These protection functions are designed to be sensitive and capable of alarming and issuing triggering commands in a case of a complex disturbance in transmission network. Aforementioned disturbances are active power oscillations and out-of-step conditions. In addition, some of these functionalities will be used as an additional criterion in a decision process inside the protection model.

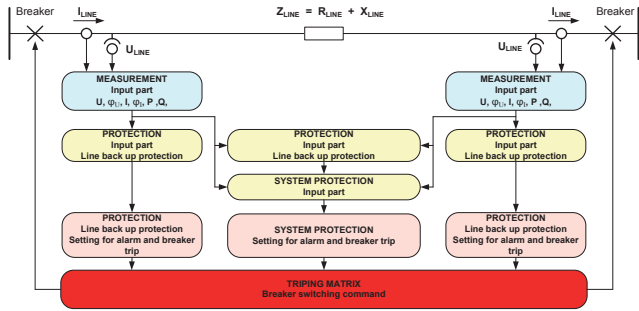

Figure 5. Developed Matlab model block diagram for line protection and monitoring functions.

Line back up functions will be used as remedial criteria for system protection function for out of step disturbance or some power swing disturbance [6].

SIMULATIONS RESULTS FROM MATLAB PLATFORM

Local oscillations in hydro power plant – real case

The oscillations originated from the hydro power plant Zakucac connected to 110 kV voltage level and propagated to 400 kV transmission network. WAM system recorded the oscillations generated by the generation units on the 400 kV transmission lines as shown on Figure 6. Highest oscillations were detected on the lines, which are closest to the source of the oscillations; in this case, the 400 kV lines Konjsko-Velebit (yellow line) and Melina-Velebit (blue line). Oscillations from 50 to 70 MW were detected on the 400 kV transmission line with oscillation frequency around 1 Hz (result from Prony analyses reveals frequency $f_0 = 0.96$ Hz and damping factor $\zeta = 0.057$). The damping factor has a positive value, which indicates existence of an undamped oscillation.

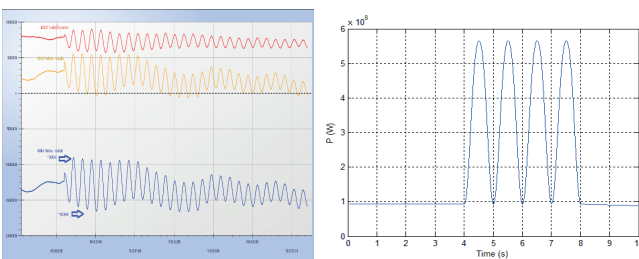

Figure 6. Active power oscillations recorded with WAM system in control center for three 400 kV lines (left). Simulated results in Matlab model (right).

The model was tuned to be able to simulate this particular disturbance which started in the mentioned power plant. The goal was to check if the impedance trajectory during this disturbance enters into any of the relay protection distance zones and power swing polygon. The results of these analyses in the R/X plane are presented on Figure 7. The impedance characteristic with the highest impedance setting is used for the power swing function. This particular polygon is the first one which is expected to be reached by the impedance trajectory.

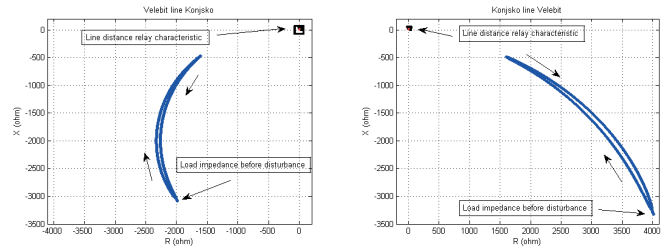

Figure 7. Line 400 kV Velebit-Konjsko, with line relay protection characteristic and impedance trajectory in R/X plane. Situation in Velebit station for line to Konjsko (left). Situation in Konjsko station for line to Velebit (right). Stations have different types of line distance relay.

Large active power oscillations in R/X plane - simulations

In this chapter two hypothetical characteristic cases will be presented which cannot be compared with real situation because such disturbances do not exist in archives thus simulations scenarios were run on verified model.

On the same lines were induced large active power oscillations in one case and in another out of step conditions. Results of those simulations were presented for station Velebit, Figure 8. In the first case impedance trajectory will not enter in relay characteristic and there will be no protection activation. Whereas for second case trajectory passed through characteristic and activate some protection functions.

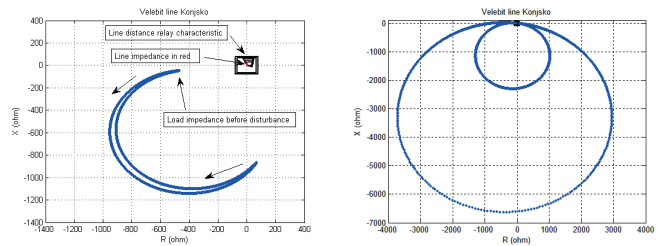

Figure 8. Line 400 kV Velebit-Konjsko, with line relay protection characteristic and impedance trajectory in R/X plane. Situation in Velebit station for line to Konjsko with large active power oscillations (left) and for an out of step conditions (right).

Study work mainly focused on all large active power oscillations. Special part of this work was analysing values for conditions when out of step develops from large oscillations. Those simulations gave a lot of insightful data because in real transmission network such events rarely happen.

Out of step conditions with angle protection operations - simulations

Every internal 400 kV line is observed with two PMUs allowing us to study and trace angle $\Delta\varphi$ values from which we derive some key performance indexes, Figure 9.

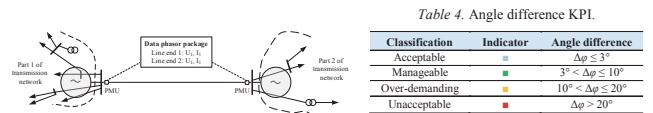

Figure 9. Simplified two machine equivalent on a transmission network line equipped with PMU devices which send phasor data packages to WAMPAC system (left) and proposal for angle difference key performance index on transmission line (right).

Table 4 shows four KPI categories for angle $\Delta\varphi$ values which can be used for monitoring the situation on each of transmission lines. Values above $\Delta\varphi = 20^\circ$ are used as a setting parameter in synchrocheck functions on transmission lines. Values for inducing the out of step conditions in model are in Table 5.

Table 4. Angle difference KPI.

Classification	Indicator	Angle difference
Acceptable	■	$\Delta\varphi \leq 3^\circ$
Manageable	■	$3^\circ < \Delta\varphi \leq 10^\circ$
Over-demanding	■	$10^\circ < \Delta\varphi \leq 20^\circ$
Unacceptable	■	$\Delta\varphi > 20^\circ$

Table 5. Simulation scenarios for out-of-step condition in Matlab model.

Disturbance origin	Disturbance characteristic	Network characteristic near disturbance origin
Konjsko	$\Delta f = 0.5 \text{ Hz}$, $f = 0.2 \text{ Hz}$	Weak and radial type network, Oscillations on one transmission tie-line
Melina	$\Delta f = 0.5 \text{ Hz}$, $f = 0.2 \text{ Hz}$	Weak and radial type network, Oscillations on one transmission tie-line
Ernestinovo	$\Delta f = 0.6 \text{ Hz}$, $f = 0.2 \text{ Hz}$	Well connected network, Oscillations on four transmission tie-lines
Zerjavinec	$\Delta f = 0.6 \text{ Hz}$, $f = 0.2 \text{ Hz}$	Well connected network, Oscillations on two transmission tie-lines, One internal transmission line disconnected

As seen values for Δf (amplitude of modulation) are slightly different in some parts of transmission network based on different characteristics of network part. Proposed protection technique which used $\Delta\phi$ is demonstrated for two lines in model. In addition, differential line protection is used as remedial criteria. Right graph from Matlab presents a situation when protection actions are inhibited while left when protection functions operated and circuit breakers were tripped by out of step condition, Figure 10.

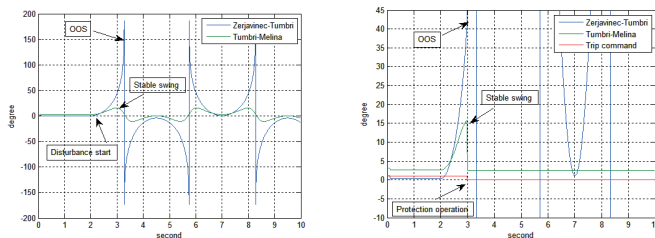

Figure 10. Active power oscillations on two 400 kV lines with voltage angle difference $\Delta\phi$ and protection operations. On line Zerjavinec-Tumbri there is an out-of-step (OOS) condition and on line Tumbri-Melina there is a power swing condition (left). Detail presenting protection activations when protection setting is reached and tripped the Zerjavinec-Tumbri line while Tumbri-Melina remained in operation (right).

Line Zerjavinec-Tumbri is disconnected but oscillations on Zerjavinec side induced by simulation still exist because measuring module in model is placed between bus and breaker. Line affected only with stable swing, Tumbri-Melina (green line) after removing the disturbance returns in stable operation. Confirmations that breaker opened on line Zerjavinec-Tumbri is graph for current on those lines, Figure 11.

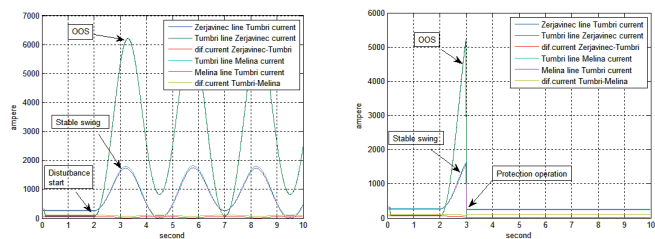

Figure 11. Remedial line protection criteria. Zerjavinec-Tumbri and Tumbri-Melina currents from both line ends with differential current protection (Δ). Out-of-step has developed on Zerjavinec-Tumbri line and on Tumbri-Melina line only stable power swing was present (left). Zerjavinec-Tumbri and Tumbri-Melina transmission line current with protection operations (right).

BIBLIOGRAPHY

- M. Larsson, P. Korba, W. Sattinger, P. Owen, "Monitoring and Control of Power System Oscillations using FACTS/HVDC and Wide-area Phasor Measurements", CIGRE Session 44, August 26-31, 2012, Paris, France, paper B5-119.
- N. Baranović, P. Andersson, I. Ivanković, K. Žubrinić-Kostović, D. Peharda, J.E. Larsson, "Experiences from Intelligent Alarm Processing and Decision Support Tools in Smart Grid Transmission Control Centers", CIGRE Session 46, August 21-26, 2016, Paris, France, paper D2-112.
- M. Stojisavljević, D. Nemeć, I. Ivanković, "WAMS in Croatian Power System", 2nd International Conference, Monitoring of Power System Dynamics Performance, Saint Petersburg, April, 2008.
- S. Han, et. al. "PMU Applications in the Korean Power System: Wide-Area Monitoring And Control (WAMAC) System", CIGRE Session 45, August 24-29, 2014, Paris, France, paper C2-124.
- S. Skok, I. Ivanković, K. Frlan, Z. Zbunjak, "Monitoring and Control of Smart Transmission Grid Based on Synchronized Measurements", APAP2011, International Conference on Advanced Power System Automation and Protection, 16-20 October 2011, Beijing, China, paper No. 1447.
- CIGRE JWG 34/35.11, "Protection Using Telecommunications", August 2001.
- S. Skok, I. Ivanković, R. Matica, I. Šturić, "Multipurpose architecture model of phasor concentrator", CIGRE Session 43, August 22-27, 2010, Paris, France, paper D2_B5_101_2010.
- V. Terzija, D. Cai, A. Vaccaro, J. Fitch, "Architecture of wide area monitoring systems and their communication requirements", CIGRE Session 43, August 22-27, 2010, Paris, France, paper D2_B5_110_2010.
- B. Kasztenny, N. Fischer, K. Fodero, A. Zvorych, "Communications and Data Synchronization for Line Current Differential Schemes", Schweitzer Engineering Laboratories, Inc. 20110906, TP 6492-01, 2011.

Both graph present currents from each side with associated line differential currents [9]. After opening breakers Tumbri-Melina side of transmission network remains in stable operations with normal operating currents. With this proposed remedial criteria we can clearly and undoubtedly say that there are no short circuit fault on lines therefore reason for high current and power flow are oscillations somewhere in transmission network. This criterion can be considered as signal for out of step protection in WAMPAC system to be fully on standby and prepared for operation.

CONCLUSIONS

Proposed technique for detection and protection will be centralized in control centres and have different approach from traditional line relay protection system for transmission lines.

Centralized protection applications use appropriated algorithm for fast and selective actions ensuring protection of transmission network from any kind of active power oscillations.

Algorithm uses voltage angle values from both transmission line ends. Algorithm effortlessly and smoothly covers whole range of possible active power oscillations in transmission network. With such applications in control centres, scarce information about wider transmission networks can be gathered too, not only lines with PMU devices. Besides monitoring any oscillations in transmission network, circuit breaker operations and short circuit faults can also be perfectly traced.

Current phasors are also available and are used for realisation of additional functionality such as a set of line protection and monitoring functions. Protection function based on phasor data are almost the same like traditional ones. Using them, some processes of supervising for traditional line protections can be developed. Alarms and events from those phasor data based protection will be forwarded to SCADA system. In the next phase of project real line back up protection is to be realized.

Crucial groundwork for having this particular protection solution is communication infrastructure across whole high voltage transmission network. This infrastructure must be reliable enough and redundant if we want to run protection functionality through them, which our TSO Company has.