

Primljen / Received: 14.2.2018.
 Ispravljen / Corrected: 29.6.2018.
 Prihvaćen / Accepted: 20.7.2018.
 Dostupno online / Available online: 10.1.2020

Influence of foundation contact pressure on response spectrum-based design

Authors:



Assist.Prof. **Ivan Kraus**, PhD. CE
 Josip Juraj Strossmayer University of Osijek
 Faculty of Civil Engineering and Arch. Osijek
ikraus@gfos.hr
Corresponding author



Damir Džakić, MCE
 BROD KONZALTING d.o.o., Zagreb
damirdzagic@hotmail.com



Assist.Prof. **Jovan Br. Papić**, PhD. CE
 Ss. Cyril and Methodius University in Skopje
 Faculty of Civil Engineering
papic@gf.ukim.edu.mk



Adriana Cerovečki, MCE
 Josip Juraj Strossmayer University of Osijek
 Faculty of Civil Engineering and Arch. Osijek
acerovecki@gfos.hr

Preliminary note

Ivan Kraus, Damir Džakić, Jovan Br. Papić, Adriana Cerovečki

Influence of foundation contact pressure on response spectrum-based design

The supports and seismic actions for structural design are usually mathematical derivatives of the data collected from soil profiles with free-field conditions. This study is based on the premise that the pressure exerted by the structure onto the soil can change resonant properties of soil and thus redirect structural design. The research was conducted on a set of 10 real soil profiles, and involves 21 case studies and the use of two methods for correction of shear wave velocity profiles in order to include contact pressure. Analytically obtained results are compared with the corresponding results obtained by means of a centrifuge experiment.

Key words:

Eurocode 8, response spectrum, experiment, centrifuge, soil profile, shallow foundations

Prethodno priopćenje

Ivan Kraus, Damir Džakić, Jovan Br. Papić, Adriana Cerovečki

Utjecaj kontaktnog pritiska od temelja na projektiranje pomoću spektra odziva

Oslonci i potresno opterećenje za projektiranje konstrukcija obično su matematički izvodi podataka dobivenih iz profila tala sa slobodnom površinom. Ovo istraživanje je vođeno pretpostavkom da pritisak od konstrukcije na tlo može promijeniti rezonantna svojstva tla i tako preusmjeriti projektiranje konstrukcija. Istraživanje je provedeno na setu od 10 stvarnih profila tla; na 21 studiji slučaja i koristeći dvije metode za korekciju profila brzina posmičnih valova s ciljem uključivanja kontaktnog pritiska. Analitički dobiveni rezultati su uspoređeni s podacima dobivenim iz eksperimenta provedenog u centrifugi.

Ključne riječi:

Eurokod 8, spektar odziva, eksperiment, centrifuga, profil tla, plitki temelji

Vorherige Mitteilung

Ivan Kraus, Damir Džakić, Jovan Br. Papić, Adriana Cerovečki

Einfluss des Anpressdrucks der Grundmauern auf die Projektierung mithilfe des Antwortspektrums

Unterstützung und Erbebenbelastung für die Projektierung von Konstruktionen sind in der Regel mathematische Ableitungen von Daten, die aus den Bodenprofilen mit freien Oberflächen erhalten werden. Diese Untersuchung basiert auf der Annahme, dass der Druck der Konstruktion auf den Boden die Resonanzeigenschaften des Bodens verändern und somit die Projektierung der Konstruktionen umlenken kann. Die Untersuchung wurde an einem Set von 10 realen Bodenprofilen durchgeführt; anhand von 21 Fallstudien und zwei Methoden werden Scherwellengeschwindigkeitsprofile mit dem Ziel korrigiert, den Anpressdruck zu berücksichtigen. Die analytisch erhaltenen Ergebnisse wurden mit den aus dem Zentrifugenexperiment erhaltenen Gegenständen verglichen.

Schlüsselwörter:

Eurocode 8, Antwortspektrum, Experiment, Zentrifuge, Bodenprofil, flache Fundamente

1. Introduction

The design of structures for earthquake resistance is practically based on both soil properties and signals passed through the soil. In other words, the seismic design of structures is based on the infinite medium that provides support for structures but also hazards encoded in strong ground motions. Due to the complexity in numerical modeling and high computational cost, if modeled as a support for the structure, the soil is usually represented using discrete springs [1, 2]. Regarding the seismic action, coded methods for seismic design of structures usually employed by engineering practice use response spectrum plots [3-8]. However, these plots are derived using fixed-base single-degree-of-freedom systems, i.e. foundation-less systems or systems firmly attached to a non-deformable medium. When set side by side, both the springs and response spectra are practically functions of shear-related properties of the soil. More specifically, they are functions of the average value of shear wave velocity in the upper 30 m of the soil profile [2, 9, 10]. Codes for seismic design usually classify the soil via the average shear wave velocity in the upper 30 m of the profile [2, 3, 11-13]. Such profiles practically have free-field conditions [14-18]. The depth of 30 m is in many cases by chance similar to the ground plan dimensions of a typical building [1]. However, this depth was selected for the classification of soils as it represents a typical drilling depth for the purposes of sampling and determination of the soil characteristics [17, 19, 20]. Further, it is known that vertical stress in the soil, due to the weight of the structure, for instance, has the greatest influence on the distribution of the shear wave velocity at depths that corresponds to foundation width [2, 21, 22]. Although the springs and response spectra, in combination or separately, can govern the design of important and potentially heavy structures [2, 4, 7, 10, 22] they do not recognize the effect of pressure induced by the foundation-structure system into the soil. Moreover, structural analyses are mainly conducted using earthquake records obtained in a free-field conditions, although even intuitively it would be reasonable to use records obtained under the structural foundation, which is de facto impracticable. Insight into a shear wave velocity profile can provide valuable information with the respect of selecting seismic demand for design of structures. However, structural engineers rarely deal with such profiles in practice. Moreover, they often assume that foundation soils within the same coded soil type respond similarly to a particular earthquake. In contrary, it is well known that even soils with the same value of shear wave velocity within the upper 30 m do not always have the same fundamental period of oscillation, since it is a function of deeper soil layers [20, 23]. This is important to bear in mind since the fundamental period of oscillation of soil may be a strong indicator of the predominant earthquake period, and thus a strong indicator of the frequency content of an earthquake [24-26]. This study was driven on the presumption that the pressure produced by the foundation-structure system onto the soil can change resonant properties of the soil and thus redirect structural design. Namely, due to the compaction, the soil can change its filtering properties and consequently the frequency content of seismic waves passing through it. This study was conducted: on a set of 10 different real soil profiles collected by the authors; 21 different

case studies of structures with different natural period of oscillation; using structures producing two different magnitudes of pressure on the soil and by using two different methods for correction of shear wave velocity profiles in order to include the pressure induced by the gravity structural loading. Results obtained analytically were in the penultimate chapter of this Paper compared with results obtained from an experiment conducted in a centrifuge at the University of Cambridge.

1.1. Average shear wave velocity of the soil profile

Average shear wave velocity within the upper 30 m of a soil profile may be determined using the following expression:

$$v_{s,30} = \frac{30}{\sum_{i=1,N} \frac{h_i}{v_{s,i}}} \quad (1)$$

where h_i is the thickness of the i -th layer of a deposit, $v_{s,i}$ shear wave velocity at a shear strain level of 10^{-5} or less of the i -th layer of a deposit, in a total of N layers within the upper 30 m of a deposit. Expression (1) is provided in Eurocode [3] and American standard [13] but also used by others in recent studies for verification and classification of sites and seismic action [9, 17]. In literature [16, 17], the following expression for estimation of the average shear wave velocity in seismically active regions may be found as:

$$v_{s,30} = \frac{\sum_{i=1,N} h_i}{\sum_{i=1,N} \frac{h_i}{v_{s,i}}} \quad (2)$$

It is clear that parameter $v_{s,30}$ significantly lacks information when compared to the entire shear wave velocity profile. This is also stressed by other authors [14, 27-29]. Recent studies [17, 27] have shown that the shear wave velocities can considerably differ within the depth of a profile, even for similar values of $v_{s,30}$. Moreover, these studies suggest that the velocity profiles cannot be sufficiently described if only upper 30 m of the foundation soil are observed, but also that the parameter $v_{s,30}$ is insufficient to describe the soil response. Recent studies [9, 27] also suggest that the foundation soil would be better described if profiles were known up to depths where the shear wave velocity reaches 800 m/s. However, such profiles would reach great depths. Obviously, it is always preferable to use the entire shear wave velocity profile in analyses, yet this is often impossible due to economic reasons.

1.2. Effect of vertical pressure from the structure on shear wave velocity distribution in soil

American guidelines for the design of earthquake resistant structures [30] stress that the classification of soil types with regard to the shear wave velocity distribution within the upper 30 m of deposit is justified for analysis of shallow founded structures. Additionally, the National

Institute of Standards and Technology (NIST) [2] recommends that the shear wave velocity should be calculated for conditions when the soil is loaded by a structure, using the following expression:

$$v_{s,F} \approx v_s(z) \cdot \left(\frac{\sigma'_v(z) + \Delta\sigma'_v(z)}{\sigma'_v(z)} \right)^{n/2} \quad (3)$$

where $v_s(z)$ is a shear wave velocity in the free-field at the depth z , $\sigma'_v(z)$ effective stress from the soil self-weight at the depth z , $\Delta\sigma'_v(z)$ increment of vertical stress due to weight of the structure at the depth z , n coefficient that varies from approximately 0.5 for granular soils to 1.0 for cohesive soils. Additional vertical stress in the soil, due to the weight of the structure, has the greatest influence on the distribution of the shear wave velocity at depths that correspond to 50 to 100 % of the foundation width (Figure 1). This is also noted by other authors [2, 21]. Furthermore, NIST suggests that the average shear wave velocity for the soil profile under a structure should be calculated using the following expression:

$$v_s = \frac{h_{s,eff}}{\sum_{i=1,N} \frac{h_i}{v_{s,F,i}}} \quad (4)$$

where $h_{s,eff}$ is the effective depth of the soil profile affected by the weight of the structure, $h_{i,eff}$ thickness of the i -th layer within the effective depth of the soil, $v_{s,F,i}$ effective value of a shear wave velocity for the i -th layer of the soil under the structure. This approach is assumed valid for structures with rigid foundations [2].

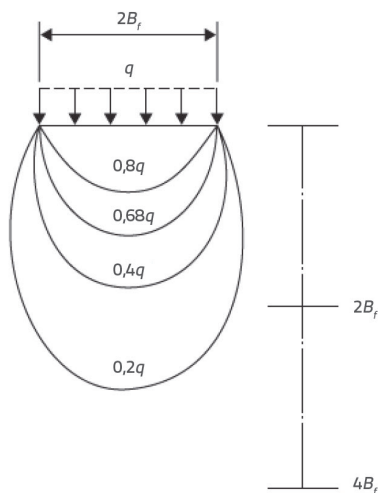

Figure 1. Stress bulb in soil under the foundation [22] (edited by the authors)

The effective vertical stress in the soil due to self-weight can be estimated using the following expression [22]:

$$\sigma'_v(z) = (\rho - \rho_w) \cdot g \cdot z \quad (5)$$

where ρ is soil mass density, ρ_w water mass density, g gravitational acceleration, z observed depth in the soil profile.

Water density in expression (5) should be ignored in a case of dry soils. When the foundation soil is loaded with rectangular or square foundation, additional vertical stress in the soil profile under the middle of the foundation may be estimated using the Boussinesq solution for distribution of stresses, using the following expression [10]:

$$\Delta\sigma'_v(z) = \frac{2q}{\pi} (a + \sin^{-1}(b)) \quad (6)$$

where a is equal to:

$$a = \frac{m \cdot n}{\sqrt{1+m^2+n^2}} \cdot \frac{1+m^2+2n^2}{(1+n^2) \cdot (m^2+n^2)} \quad (7)$$

and b :

$$b = \frac{m}{\sqrt{m^2+n^2} \cdot \sqrt{1+n^2}} \quad (8)$$

where q is uniform vertical load per unit area, and m and n are parameters that take into account the foundation geometry and observed depth in the foundation soil. The two parameters can be calculated by following expressions:

$$m = \frac{L_f}{B_f} \quad (9)$$

$$n = \frac{z}{B_f} \quad (10)$$

where L_f and B_f are half-length and half-width of the foundation respectively, z observed depth in the foundation soil, measured from the ground surface. For practical reasons, the calculation of additional stresses within the soil, using the expression (6) will be referred to as the m - n method further in this Paper. Besides the previously described Boussinesq method, the so-called 2:1 method is also widespread in engineering practice [2, 10, 31]. The subsurface distribution of the stress is illustrated as shown in Figure 2.

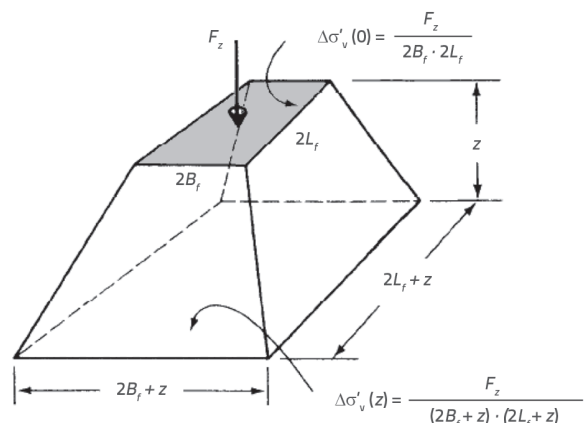

Figure 2. Approximate distribution of a vertical stress under the square foundation, according to the 2:1 method [31] (edited by the authors)

Table 1. Soil profiles used in this study

ID	Town	Country	Source
1	Bar	Montenegro	[32]
2	Bucharest	Romania	[33]
3	Lefkada	Greece	[33]
4	Osijek	Croatia	[1]
5	Osijek	Croatia	[1]
6	Ploče	Croatia	[1]
7	Sirova Katalena	Croatia	[1]
8	Sisak	Croatia	[1]
9	Thessaloniki	Greece	[33]
10	Ulcinj	Montenegro	[32]

According to the 2:1 method, the stress at a certain depth below the foundation may be determined using the following expression [31]:

$$\Delta\sigma'_v(z) = \frac{F_z}{(2B_f + z) \cdot (2L_f + z)} \quad (11)$$

where F_z is the vertical load affecting the foundation. The application of the 2:1 method is also suggested in [2].

2. Study environment: selected soil profiles and structures

To demonstrate the influence of the vertical loading from a structure on the shear wave velocity distribution in the soil the methods m-n and 2:1 were both applied on a set comprising of 10 real, randomly selected and well-explored soil profiles from Romania, Montenegro, Greece and Croatia. Reference list of soil profiles used in this study is given in Table 1.

Every soil profile in Table 1 is later in this Paper associated with a corresponding soil class as defined in Eurocode [3]. It is assumed for the soil profiles observed here that the water table is very deep. Following the definition provided in Eurocode [3], soil class A includes profiles whose average shear wave velocity exceeds 800 m/s, while the soil class B is characterized by the average shear wave velocities that range from 360 to 800 m/s. Soil class C includes profiles with average shear velocities between 180 and 360 m/s, while the upper limit of average shear wave velocity for soil class D corresponds to 180 m/s. Soil class E includes profiles listed under soil classes C and D but with the bedrock located at a depth of 20 m below the ground surface. Apart from the soil classes mentioned in this Paper two special soil classes exist in [3], although they are not observed here. This study assumes that the soil density and the Poisson's ratio for the soil are constant over the whole depth of the soil profile and equal to 2000 kg/m³ and 0,30 respectively [1]. The

study was conducted based on the assumption that a light ($q = 100$ kPa) and heavy ($q = 300$ kPa) structure will be founded above the soil profiles addressed in Table 1. Recent studies [34, 35] demonstrated that soil properties highly depend on the applied load. The selection of structures used in this study was conducted following the same principles and concepts described in [36-39]. Structures are assumed regular and shallow founded on a square foundation with side lengths of 20 m. The foundation length of 20 m corresponds to the maximum depth considered for the soil class E as defined in the Eurocode [3]. Damping of 5 % was assumed for all the cases observed within this study. Such value of damping can encompass energy dissipation in structure and foundation soil [2].

3. Results and discussion

3.1. On the change of soil class

The study conducted using m-n and 2:1 methods showed that the vertical loading caused by the foundation-structure system could have a large impact on the alteration of shear wave velocity in the soil. The average shear wave velocity distributions for the soil profiles with free-field conditions are obtained directly from the literature or from measurements. The average shear wave velocity distributions of the soil profiles under structures were calculated using the expression (4). A leap from lower to higher soil class was detected in 50 % of the observed cases (Table 2). For the soil that supports light and heavy structures, an increase in average shear wave velocity of 12,5 % and 26,5 % was observed, respectively (Table 2 and Figure 3).

The study showed that both the m-n and 2:1 method provide similar redistributions of vertical stress and shear wave velocities in the soil profile below the structure (Figure 4). The study confirms that the effect of vertical loading from a structure on the soil is almost negligible at depths greater than the half-length of the foundation (Figure 4).

Table 2. Soil profiles observed in the study described by the average shear wave velocity within the first 30 m of the deposit in free-field and when loaded by a structure. Shaded cells mark leaps in soil classification.

ID	Soil class according to [3] ($v_{s,30}$ u m/s)				
	Free-field	m-n method		2:1 method	
		100 kPa	300 kPa	100 kPa	300 kPa
1	B (459)	B (508)	B (568)	B (498)	B (545)
2	D (165)	C (181)	C (203)	D (178)	C (195)
3	C (325)	B (365)	B (414)	C (357)	B (397)
4	C (230)	C (266)	C (304)	C (258)	C (290)
5	D (172)	C (200)	C (231)	C (194)	C (219)
6	D (154)	C (182)	C (210)	D (177)	C (200)
7	C (349)	B (410)	B (475)	B (401)	B (455)
8	C (235)	C (280)	C (326)	C (271)	C (309)
9	C (288)	C (319)	C (355)	C (313)	C (342)
10	B (400)	B (438)	B (483)	B (431)	B (467)

Osjenčane ćelije označavaju skok u kategorizaciji tla

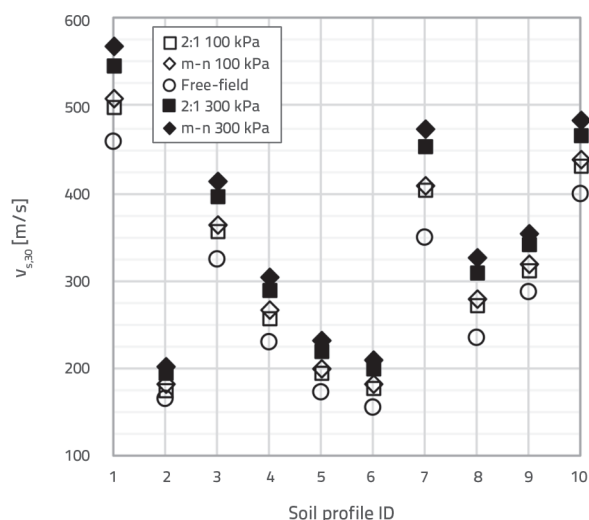

Figure 3. Average shear wave velocities of soil profiles for free-field conditions and when loaded by structures.

Inter alia, Figure 4 shows the soil profile of Sirova Katalena for which the shear wave velocity distribution is not provided up to the depth of 30 m. Namely, the shear wave velocity distribution for this profile was defined based on the data obtained by on-site measurements, while authors were not provided with any additional data for this profile. This allows the presumption that the shear wave velocity distribution at greater depths is similar to the deepest measured velocity value in the profile. Additionally, one may also presume

existence of very stiff soil in deeper layers, e.g. soils with average shear wave velocity equal to or greater than 800 m/s. These presumptions can result in assigning a wrong soil class to that profile. Although the Sirova Katalena profile could be classified as an E soil type, in this study it was classified as a C soil type.

Finally, it was noticed that soil classes C and D are much more sensitive to structural loading, compared to the class B soil. This mostly results from the fact that the soil class B covers a significantly broader area of average shear wave velocities, when compared to the soil classes C and D. Figures 5 and 6 show the change of spectral acceleration due to the leap from a softer to a stiffer type of soil induced by additional pressure acting over the soil profile. Figure 5 shows that including of the contact pressure effects into response spectrum method can result in higher spectral acceleration for short-period structures founded on a C type soil profile. On the other hand, Figure 6 shows that including the contact pressure effects into response spectrum method can result in lower spectral acceleration for short-period structures founded on a D type soil profiles. However, for the case of long period structures the same trend was observed when including the contact pressure effects into response spectrum method, regardless of foundation soil class. In that case, spectral accelerations are lower, regardless whether the structure is founded on a C or D class soil profile. Furthermore, by comparing Figures 5 and 6 it was observed that the response spectra plateau tapers and shifts to lower periods due to the foundation contact pressure effects.

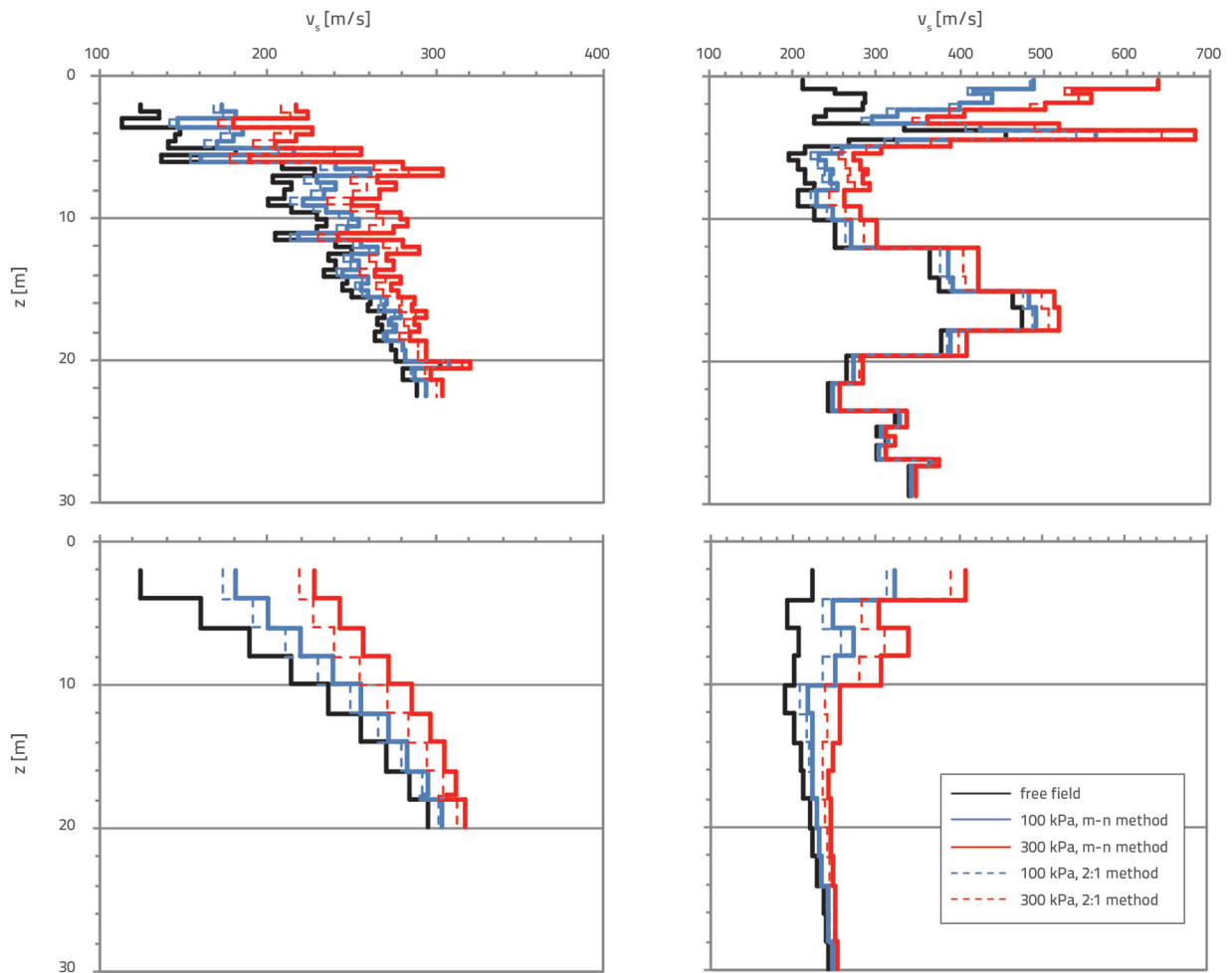

Figure 4. Shear wave velocity distribution along the depth of the profile in a load-free field and under the structure with a foundation of 20x20 m for the following towns: Lefkada (top left) and Sirova Katalena (bottom left), Thessaloniki (top right) and Osijek (bottom right)

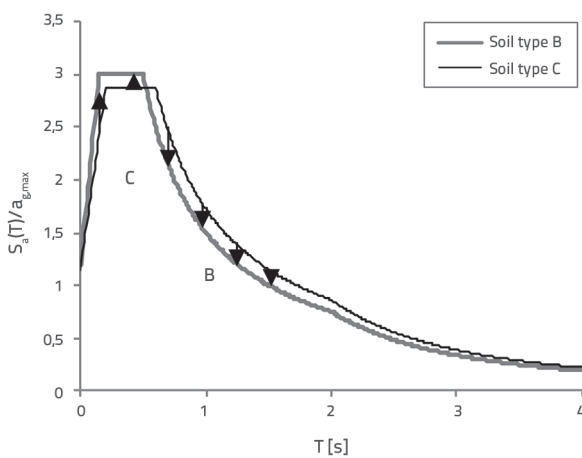

Figure 5. Leap from a C soil type related spectra (thin black line) to a B soil type related spectra (thick grey line) due to the influence of vertical stress in the soil

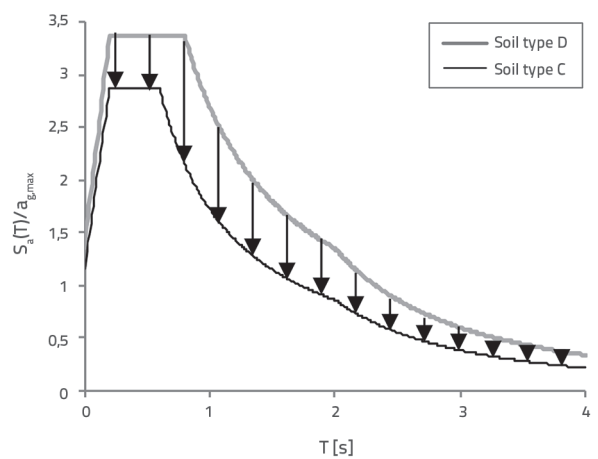

Figure 6. Leap from a D soil type related spectra (thick grey line) to a C soil type related spectra (thin black line) due to the influence of vertical stress in the soil

3.2. On the change of the natural period of oscillation of the soil-foundation-structure system

As already mentioned, natural period of oscillation is one of the main dynamic properties of a structure and soil-structure system. The period of oscillation of the whole soil-structure system can be approximated by following expression [1, 15, 40]:

$$T_{ssi} = T_1 \sqrt{1 + \frac{k}{k_x} + \frac{k \cdot H^2}{k_{yy}}} \tag{12}$$

where T_1 is a first natural period of oscillation of a fixed-base inverted pendulum with stiffness k and the height of the center of mass H , k_x and k_{yy} are real parts of the impedance functions for horizontal translation and rotation in vertical plane, respectively. The inverted pendulum with its natural period represents an equivalent to a regular structure. In this study the first natural period of oscillation of fixed-base structure, i.e. building, was estimated using the following empirical expression [41]:

$$T_1 = 0,1 \cdot N_{storey} \tag{13}$$

where N_{storey} is a number of storeys, accepting the assumption that each storey is about 3 m high. Expression (13) is allowed for both steel and concrete structures not exceeding 12 storeys in height. It is assumed that the center of mass of the building is located at 70 % of the total height [42]. In this chapter, we observed structure-foundation systems producing 100 kPa of pressure onto the soil. It was assumed that the weight of the structure W_s equals three times the weight of the foundation. The stiffness of the inverted pendulum was then calculated using a well-known expression [42]:

$$T_1 = 2\pi \sqrt{\frac{m}{k}} \tag{14}$$

where m is mass of the structure. Previous studies [43-45] showed that expressions (13) and (14) (former one as empirical and the latter one based on mass and stiffness properties),

provide similar results for the same structure observed. The real parts of the impedance functions can be estimated by following expressions [2, 40]:

$$k_x = \frac{8 \cdot G_s \cdot B_f}{2 - \eta_s} \tag{15}$$

$$k_{yy} = \frac{8 \cdot G_s \cdot B_f^3}{3 \cdot (1 - \eta_s)} \tag{16}$$

where G_s is the average value of soil shear modulus, B_f half-width of the foundation in direction of loads acting on structure and η_s is Poisson's ratio for foundation soil. Value of average shear modulus for foundation soil can be estimated by following expression [2]:

$$G_s = \rho_s \cdot v_s^2 \tag{17}$$

where ρ_s is soil density and v_s is average shear wave velocity for the foundation soil profile. Values of v_s used here are provided in Table 2. Further, Table 3 provides values of the percentile modification δ of the spectral acceleration values, which is calculated as follows:

$$\delta = \frac{S_e(T_{ssi}) - S_e(T_1)}{S_e(T_1)} \tag{18}$$

where $S_e(T_1)$ and $S_e(T_{ssi})$ are elastic spectral acceleration for fixed-base structure and the soil-structure system respectively, calculated according to [3]. In this study, the values of $S_e(T_1)$ are calculated following conventional approach using fixed-base structure while the values of $S_e(T_{ssi})$ are calculated for soil-structure systems taking into account the influence of the pressure from foundation-structure system acting onto the soil. Table 3 shows that incorporating soil-structure interaction effects in the response spectrum method may result in up to 50 % higher forces in very stiff and squat structures. This brings to the conclusion that existing shallow founded short-period structures on soft soils, analyzed using conventional design, may be severely underdesigned and unsafe. On the other hand, Table 3 shows that inertial forces in long-period structures

Table 3. The percentile modification of the spectral acceleration values

N_{storey}	δ [%]		
	Bucharest and Ploče	Lefkada and Sirova Katalena	Osijek
1	+22	+49	+22
2	-15	+4	-15
3	-15	+4	-15
4	-15	+4	-15
5	-15	-2	-15
6	-26	-17	-25
7	-36	-17	-35

may be overestimated. However, such type of structures is more susceptible to displacements. Finally, vertical loading from a structure may change the resonant frequency of the soil profile and thus alter its filtering capabilities [17, 27, 40, 46]. Consequently, vertical loading from a structure may alter the frequency content of an earthquake that will attack the structure. Evidence of this is provided in several studies by well-known experts [25, 47-50]. Yet, it is clear that we need more precise inclusion of the structural loading effects on the soil in the coded response spectrum method. Especially since the damping in soil is not considered in this Paper in greater extent. This is being researched in a study that is currently underway.

4. Experimental verification of the study

Results and conclusions stated after the analytical study were verified against results obtained in an experimental environment. Unless otherwise stated, all test results and geometry presented in this chapter are in prototype scale. The experiment comprising two structural models was carried out in centrifuge at the University of Cambridge. Both structures tested were shallowly founded on a sand bed with the relative density of 55 % and thickness of 19,5 m (Figure 7). The large and the small model had bearing pressure q of 100 and 50 kPa respectively. Both models had natural period T_1 of around 1 s. The two models were simultaneously tested at 50- g during the same centrifuge flight CH1: Flight 3, Earthquake 1. This Paper uses only acceleration time history records obtained from accelerometer A1 located below the foundation of the large model and accelerometer A5 placed in the free-field (Figure 7). Namely, the large model has bearing pressure that matches the bearing pressure of 100 kPa used in previous chapters of this Paper, and thus only the large model was additionally observed to verify the analytical results and conclusions. The horizontal distance between the accelerometers below the foundation and in the free-field was around 8,5 m. More information about models is provided in a report by Heron et al. [51]. The obtained experimental data was filtered before its

application, following the procedure as described in [1]. Figure 8 provides a comparison of response spectra obtained from signals recorded using accelerometers A1 and A5.

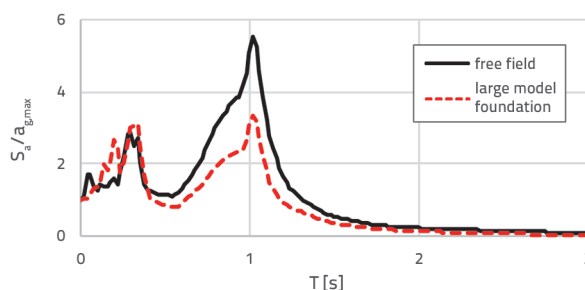

Figure 8. Response spectra obtained from the University of Cambridge centrifuge experiment for a free-field (black continuous line) and under a large model foundation (red dashed line)

After a close inspection of plots provided in Figure 8, it was observed that in range of periods between 0,4 s and 1,5 s acceleration values of the signal recorded below the foundation of the large model are up to 40 % smaller when compared to acceleration values of the signal recorded in the free-field. This supports analytically obtained results provided in Figures 5 and 6. Still, spectral acceleration values significantly fluctuate for periods between 0 and 0,40 s so no unambiguous interpretation for short-period structures could be made here. The shift of the peak part of the response spectrum was not observed for the experimentally obtained signal, as it was in the case of the coded response spectra (Figures 5 and 6).

5. Conclusions

This Paper investigates the influence of structural weight on shear wave velocity distribution within foundation soil profile in the light of the response spectrum method. The study was driven by the hypothesis that the pressure produced by the foundation-structure system onto the soil can change resonant properties of

the soil and thus redirect the structural design. This study was conducted: on a set of 10 different real soil profiles collected by the authors; 21 different case studies with structures having different natural period of oscillation; using structures producing two different magnitudes of pressure on the soil and by using two different methods for correction of shear wave velocity profiles in order to include the pressure induced by the gravity structural loading. Results obtained analytically in this study were verified against the experimental counterparts obtained from centrifuge at the University of Cambridge. Good matching between the results was observed and the following was concluded:

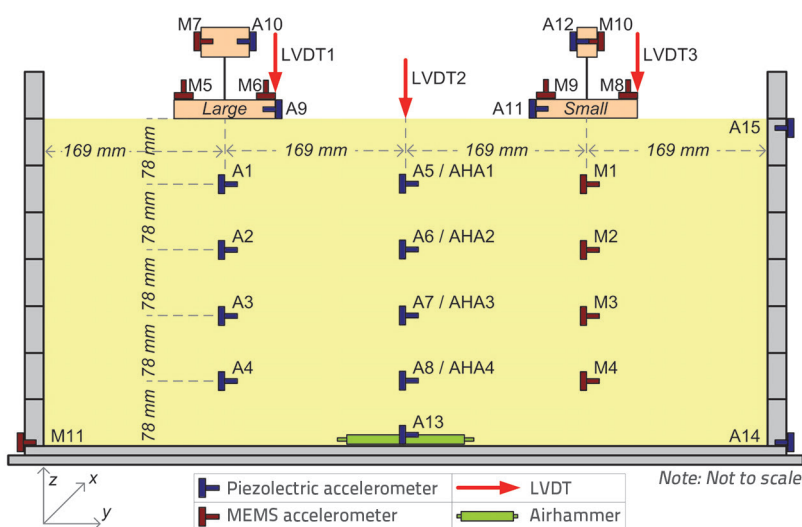

Figure 7. Layout of the model tested at the University of Cambridge (in model scale) [51]

- the m-n and 2:1 methods used for correction of shear wave velocity profiles in order to include the vertical loading from a structure provide similar results;
- the response spectrum method is sensitive to the effects of the soil-structure interaction;
- additional pressure over foundation soil induced by the gravity structural loading alters the average shear wave velocity distribution in the soil;
- European coded soil classes C and D are much more sensitive to the gravity structural loading when compared to the soil class B;
- for structures producing 100 kPa and 300 kPa of pressure onto the soil an increase in average shear wave velocity of 12,5 % and 26,5 % was observed, respectively;
- incorporation of soil-structure interaction effects into the response spectrum method may result in up to 50 % higher forces for stiff and squat structures;
- long-period structures may be overdimensioned if one omits to include soil-structure interaction effects when conducting analysis using the response spectrum method.

All of this suggests that the parameter $v_{s,30}$ is one of the key parameters in code-based design that steers the seismic demand for structures. Nonetheless, issues related to the influence of gravity structural loading on shear wave velocity distribution can be significant in following cases:

- when structures are supported by a combination of different types of foundations;

- when soil properties significantly vary across the footprint of the structure.

These issues can occur under the foundations of industrial buildings, stadiums, shopping malls and bridges, among others. These cases are also open niches for future research. A further research in this field includes the damping in the foundation soil and the soil-structure interaction effects on velocity and displacement response spectra. Rocking and sliding effects of the building on the foundation soil will also be observed.

Acknowledgments

The authors would like to thank: Mr. Goran Mitrović from the Geotechnical Department at the Institut IGH d.d. for providing detailed and well explored soil profiles for this study; NISEE/PEER Library at the University of California, Berkeley and the Technical Chamber of Greece Digital Library for generously providing us with the paper referred here as [32] and also the data providers and the SERIES Project (funded by the European Community's Seventh Framework Programme [FP7/2007-2013] under grant agreement n° 227887) for providing access to the experimental data herein described in chapter 4. This Paper was carried out as part of the internal project PENDULARUM and supported by Grant No. 15-04 by the Faculty of Civil Engineering Osijek. Finally, we would like to thank two anonymous reviewers for their keen critical remarks and helpful suggestions that contributed to the clarity of this Paper.

REFERENCES

- [1] Kraus, I.: Seismic response spectra of shallow founded structures on soft soils. PhD. University of Osijek, 2014.
- [2] NIST (National Institute of Standards and Technology). Soil-Structure Interaction for Building Structures, NIST/GCR 12-917-21. Prepared by the NEHRP Consultants Joint Venture for the National Institute of Standards and Technology, Gaithersburg, Maryland, USA, 2012. Available at: www.nehrp.gov [January 18, 2018]
- [3] CEN (Comité Européen de Normalisation). Eurokod 8: Design of structures for earthquake resistance, Part 1: General rules, seismic actions and rules for buildings, EN 1998-1. Brussels, Belgium, 2004.
- [4] Franetović, M., Mandić Ivanković, A., Radić, J.: Seismic assessment of existing reinforced-concrete arch bridges, GRAĐEVINAR, 66 (2014) 8, pp. 691-703, <https://doi.org/10.14256/JCE.1073.2014>
- [5] Krolo, P., Čaušević, M., Bulić, M.: Nonlinear seismic analysis of steel frame with semi-rigid joints, GRAĐEVINAR, 67 (2015) 6, pp. 573-583, <https://doi.org/10.14256/JCE.1139.2014>
- [6] Radić, I., Markulak, D., Sigmund, V.: Controlled seismic behaviour of masonry-infilled steel frames, GRAĐEVINAR, 68 (2016) 11, pp. 883-893, <https://doi.org/10.14256/JCE.1673.2016>
- [7] Šavor Novak, M., Lazarević, D., Atalić, J.: Influence of spatial variability of ground motion on seismic response of bridges, GRAĐEVINAR, 67 (2015) 10, pp. 943-957, <https://doi.org/10.14256/JCE.1303.2015>
- [8] Đuran, M., Lukačević, I., Dujmović, D.: Linear and non-linear analyses of cable-stayed steel frame subjected to seismic actions, Electronic Journal of the Faculty of Civil Engineering Osijek, e-GFOS, 8 (2017) 14, <https://doi.org/10.13167/2017.14.8>
- [9] Ptilakis, K., Riga, E., Anastasiadis, A.: Design spectra and amplification factors for Eurokod 8. Bulletin of Earthquake Engineering, 10 (2012), pp. 1377-1400.
- [10] Das, B.M.: Shallow Foundations – Bearing Capacity and Settlement. 2nd ed. CRC Press, Taylor & Francis Group, Boca Raton, 2009.
- [11] IAEE (International Association for Earthquake Engineering). Regulations for Seismic Design: A World List, Tokyo, Japan, 2012. Available at: www.iaee.or.jp/worldlist.html [January 18, 2018]
- [12] ASCE (American Society of Civil Engineers). Seismic analysis of safety-related nuclear structures. ASCE/SEI 4-98. American Society of Civil Engineers, Reston, Virginia, USA, 2000.
- [13] ASCE (American Society of Civil Engineers). Minimum design loads for buildings and other structures. ASCE/SEI 7-10. American Society of Civil Engineers, Reston, Virginia, USA, 2010.
- [14] Brown, L.T., Diehl, J.G., Nigbor, R.L.: A simplified procedure to measure average shear-wave velocity to a depth of 30 meters (VS30). Proceedings of the 12th World Conference on Earthquake Engineering, Auckland, New Zealand, 2000.

- [15] Kraus, I., Knappett, J.A., Morić, D.: Seismic behavior of shallow founded inverted pendulum on soft soil In: P. Ivanyi, ed., Abstracts of the 9th International PhD & DLA Symposium, 92-92. Pollack Mihaly Faculty of Engineering and Information Technology, Pecs, 2013.
- [16] Borchardt, R.D.: VS30 - A site-characterization parameter for use in building codes, simplified earthquake resistant design GMPEs, and ShakeMaps. Proceedings of the 15th World Conference on Earthquake Engineering, Lisbon, Portugal, 2012.
- [17] Lee, S.H., Sun, C.G., Yoon, J.K., Kim, D.S.: Development and Verification of a New Site Classification System and Site Coefficients for Regions of Shallow Bedrock in Korea. *Journal of Earthquake Engineering*, 16 (2012), pp. 795-819.
- [18] Trifunac, M.D.: Earthquake response spectra for performance based design - A critical review. *Soil Dynamics and Earthquake Engineering*, 37 (2012), pp. 73-83.
- [19] Tang, H.T., Tang, Y.K., Stepp, J.C.: Lotung large-scale seismic experiment and soil-structure interaction method validation. *Nuclear Engineering and Design*, 123 (1990), pp. 397-412.
- [20] Pitalakis, K., Anastasiadis, A., Riga, E.: New site classification scheme and associated site amplification factors. SHARE Deliverable D4.3. 2012. Available at: www.share-eu.org/node/52 [January 18, 2018]
- [21] Roje-Bonacci, T.: *Mehanika tla*. 2nd Edition. University of Split, Tiskara Poljica d.o.o., Dugi rat, 2003 (in Croatian)
- [22] Knappett, J.A., Craig, R.F.: *Craig's Soil Mechanics*. 8th ed. Spon Press, Oxon, UK, 2012.
- [23] Pitalakis, K., Gazepis, C., Anastasiadis, A.: Design Response Spectra and Soil Classification for Seismic Code Provisions. Proceedings of the 13th World Conference on Earthquake Engineering, Vancouver, B.C., Canada, 2004.
- [24] Newmark, N.M., Hall, W.J.: Seismic design criteria for nuclear reactor facilities. Proceedings of the 4th World Conference on Earthquake Engineering, Santiago, Chile, 37-50, 1969.
- [25] Trifunac, M.D., Ivanović, S.S., Todorovska, M.I.: Apparent periods of a building. I: Fourier Analysis. *Journal of Structural Engineering*, 127 (2001), pp. 517-526.
- [26] Choobasti, A.J., Rezaei, S., Farrokhzad, F.: Evaluation of site response characteristics using microtremors. *Građevinar*, 65 (2013), pp. 731-741.
- [27] Régnier, J. et al.: Revisiting Vs30 as a proxy parameter for site effects: a case study using KiKnet data. Proceedings of 5th International Conference on Earthquake Geotechnical Engineering (SICEGE). Santiago, Chile, 800-804, 2011.
- [28] Cadet, H., Bard, P.Y., Duval, A.M., Bertrand, E.: Site effect assessment using KiK-net data: Part 2. Site amplification prediction equation based on f0 and Vs. *Bulletin of Earthquake Engineering*, 10 (2012), pp. 451-489.
- [29] Lee, V.W., Trifunac, M.D.: Should average shear-wave velocity in the 30 m of soil be used to describe seismic amplification?. *Soil Dynamics and Earthquake Engineering*, 30 (2010), pp. 1250-1258, 2010.
- [30] FEMA (Federal Emergency Management Agency). NEHRP (National Earthquake Hazards Reduction Program) Recommended Seismic Provisions for New Buildings and Other Structures. FEMA P-750. Prepared by the Building Seismic Safety Council for the Federal Emergency Management Agency, Washington, D.C., USA, 2009. Available at: www.fema.gov [January 18, 2018]
- [31] Holtz, R.D., Kovacs, W.D.: *An introduction to geotechnical engineering*. Prentice Hall, Englewood Cliffs, New Jersey, USA, 1981.
- [32] Talaganov, K., Aleksovski, D., Gadza, V.: Analysis of the influence of local soil conditions upon maximum accelerations based on data from 1979 Montenegro earthquake. Proceedings of the 7th European Conference on Earthquake Engineering, Technical Chamber of Greece, Athens, Greece, 2 (1982), pp. 423-430.
- [33] Ambraseys, N. et al.: Dissemination of European Strong-Motion Data, Volume 2. CD ROM collection. Engineering and Physical Sciences Research Council, United Kingdom, 2004.
- [34] Dong, J., Shao, L.: Experimental study on deformation properties of unsaturated compacted soil based on digital image measurement. *Engineering Review*, 34 (2014) 3, pp. 217-222.
- [35] Lukić Kristić, I., Szavits-Nossan, V., Mišević, P.: Direct method for determination of shallow foundation settlements. *Građevinar*, 69 (2017) 6, pp. 467-477, <https://doi.org/10.14256/JCE.1926.2016>
- [36] Zeng, X., Steedman, R.S.: Bearing capacity failure of shallow foundations in earthquake. *Géotechnique*, 48 (1998), pp. 235-256.
- [37] Negro, P., Paolucci, R., Pedretti, S., Faccioli, A.E.: Large scale soil-structure interaction experiments on sands under cyclic loading. Proceedings of the 12th World Conference on Earthquake Engineering, Auckland, New Zealand, 2000.
- [38] Paolucci, R. et al.: Seismic behaviour of shallow foundations: large scale experiments vs. numerical modelling and implications for performance based design. In: Proceedings of the 1st US-Italy seismic bridge workshop, Eucentre, Pavia, Italy, 107-111, 2007.
- [39] Escoffier, S., Chazelas, J.L.: Seismic soil structure interaction: a parametric study on shallow foundations. In: C. Gaudin and D. White, eds. Proceedings of the 8th International Conference on Physical Modelling in Geotechnics 2014 (ICPMG2014), 1045-1051, CRC Press, Perth, Australia, 2014.
- [40] JSCE (Japan Society of Civil Engineers). Earthquake resistant design codes in Japan. Maruzen Co., Ltd. International Division, Tokyo, Japan, 2000.
- [41] FEMA (Federal Emergency Management Agency). NEHRP (National Earthquake Hazards Reduction Program) Recommended Provisions for Seismic Regulations for New Buildings and Other Structures. FEMA 450. Prepared by the Building Seismic Safety Council for the Federal Emergency Management Agency, Washington, D.C., USA, 2003. Available at: www.fema.gov [June 25, 2018]
- [42] Čaušević, M.: *Dinamika konstrukcija - potresno inženjerstvo, aerodinamika, konstrukcijske euronorme*, Zagreb: Golden marketing-Tehnička knjiga, 2010
- [43] Crowley, H., Pinho, R.: Period-height relationship for existing European reinforced concrete buildings, *Journal of Earthquake Engineering*, 8 (2004) S1, pp. 93-119.
- [44] Salameh, C. et al.: Seismic response of Beirut (Lebanon) buildings: instrumental results from ambient vibration, *Bulletin of Earthquake Engineering*, 14 (2016) 10, pp. 2705-2730.
- [45] Draganić, H., Hadzima-Nyarko, M., Morić, D.: Comparison of RC frames periods with the empiric expressions given in Eurokod 8, *Technical Gazette*, 17 (2010) 1, pp. 93-100.
- [46] SNZ (Standards New Zealand). Structural design actions, Part 5: Earthquake actions - New Zealand - Commentary, NZS 1170.5 Supp 1:2004. Wellington, New Zealand, 2004.
- [47] Jennings, P.C., Bielak, J.: Dynamics of building-soil interaction. Report No. EERL 72-01. Earthquake Engineering Research Laboratory, California Institute of Technology, Pasadena, California, USA, 1972.
- [48] Poland, C., Soulages, J., Sun, J., Mejia, L.: Quantifying the effect of soil-structure interaction for use in building design. Data Utilization Report CSMIP/00-02(OSMS 00-04), California Strong Motion Instrumentation Program, California Department of Conservation, California, USA, 2000.
- [49] Finn, W.D.L., Pandey, B.H., Ventura, C.E.: Modeling soil-foundation-structure interaction. *The Structural Design of Tall and Special Buildings*, 20 (2011), pp. 47-62.
- [50] Bech, D. et al.: Common structural deficiencies identified in Canterbury buildings and observed versus predicted performance. *Earthquake Spectra*, 30 (2014), pp. 335-362.
- [51] Heron, C. et al.: Deliverable 14.3 - Report on centrifuge test techniques with soil structure interaction. Workpackage 14, Project No. 227887, 2012.