

Domagoj Tončinić, Mirna Cvetko

Instrumenta inscripta Tiluriensia Instrumenta inscripta Tiluriensia

Domagoj Tončinić
Mirna Cvetko
HR, 10000 Zagreb
Odsjek za arheologiju
Filozofski fakultet Sveučilišta u Zagrebu
Ivana Lučića 3
dtoncinic@ffzg.unizg.hr
mvukov@ffzg.hr

UDK: 902/908(497.583Tilurij)“-0100/+0300”:069 Muzej
Triljskog kraj, Muzej Cetinske krajine, Arheološki
muzej u Splitu,
902/908(497.583Tilurij)“-0100/+0300”]:2
523.6(497.583Sinj)
Prethodno priopćenje
Primljeno: 17. 12. 2020.
Prihvaćeno: 15. 2. 2021.

U ovom je radu predstavljena skupina pokretnih arheoloških nalaza s natpisima s područja rimskog legijskog logora Tilurija (danas selo Gardun kod Trilja). Znanstvenom analizom obuhvaćena je tzv. *instrumenta inscripta*, odnosno keramički, stakleni, koštani i metalni nalazi koji na sebi sadrže natpis i/ili pečat. Riječ je o nalazima iz sustavnih arheoloških istraživanja, kao i o nalazima koji su danas pohranjeni u Muzeju triljskog kraja u Trilju, Muzeju Cetinske krajine u Sinju, Arheološkoj zbirci Franjevačkog samostana u Sinju, Arheološkom muzeju u Splitu ili su zabilježeni u starijoj literaturi. Većina nalaza pripada razdoblju prve polovice i sredine 1. st. po. Kr., dok se pojedini nalazi mogu datirati i na sam kraj 1. st. pr. Kr. Njihova se datacija time uvelike preklapa s datacijom Tilurija kao rimskoga legijskog logora i kasnije logora pomoćnih postrojbi. Mali broj nalaza može se datirati u razdoblje prije nego što je Tilurij početkom 1. st. po. Kr. postao logor VII. legije. Isto tako mali broj nalaza svjedoči i o nastavku života u Tiluriju nakon što je pretao biti rimsko vojno uporište nakon sredine 3. st.

Domagoj Tončinić
Mirna Cvetko
Croatia, 10000 Zagreb
Archaeology Department
Faculty of Humanities and Social Sciences in Zagreb
Ivana Lučića 3
dtoncinic@ffzg.unizg.hr
mvukov@ffzg.hr

UDC: 902/908(497.583Tilurij)“-0100/+0300”:069 Muzej
Triljskog kraj, Muzej Cetinske krajine,
Arheološki muzej u Splitu,
902/908(497.583Tilurij)“-0100/+0300”]:2-
523.6(497.583Sinj)
Advance notice
Received: 17. 12. 2020.
Accepted: 15. 2. 2021.

Movable archaeological finds bearing inscriptions from the area of the Roman legionary fortress at Tilurium (today the village of Gardun near Trilj) are presented in this paper. The scholarly analysis encompassed the so-called *instrumenta inscripta*, i.e., the ceramic, glass, bone and metallic finds which have an inscription and/or stamp on them. These are finds yielded by systematic archaeological excavations, as well as finds today stored in the Trilj Regional Museum in Trilj, the Cetina Territorial Museum in Sinj, the Franciscan Monastery Archaeological Collection in Sinj, the Archaeological Museum in Split or finds recorded in the older scholarly literature. Most of the finds date to the period from the first half of the 1st century AD, while individual finds can be dated to the very end of the 1st century BC. Their dating thereby largely overlaps with the dating of Tilurium as a Roman legionary fortress and then a fort used by auxiliary contingents. A small number of finds can be dated to the period prior to the time when Tilurium became the fortress of Legio VII at the beginning of the 1st century AD. By the same token, a small number of finds testifies to the continuity of life in Tilurium once it ceased being a Roman military base after the mid-3rd century.

Ključne riječi: rimska provincija Dalmacija, Tilurium, instrumenta inscripta, rimska vojska

Key words: Roman province of Dalmatia, Tilurium, instrumenta inscripta, Roman army

UVOD

Odsjek za arheologiju Filozofskog fakulteta Sveučilišta u Zagrebu, u okviru projekta Hrvatske zaklade za znanost IP-2018-01-4934 “Razumijevanje rimskih granica: primjer istočnog Jadrana” (AdriaRom), provodi istraživanja arheoloških ostataka rimske vojničke arhitekture u zaleđu Jadera i Salone kako bi se utvrdilo jesu li ti objekti bili dijelovi obrambene granice ili nisu.¹ U svrhu provedbe navedenog istraživanja izabrana su testna područja – okolica rimskih legijskih logora *Burnum* i *Tilurium*, kao i okolina pretpostavljenih kastela *Promona*, *Magnum* i *Andetrium* – te metodološki pristup temeljen na 7 koraka. Za uspješnu provedbu rekonstrukcije obrambene granice prvo je potrebno utvrditi položaje za koje se može pretpostaviti da su vojna nalazišta i formulirati strukturne pokazatelje (ceste, legijske logore, kastele i promatračnice, jarke, palisade i sl.). U zaleđu Jadera i Salone poznata su dva legijska logora (*Burnum* i *Tilurium*), a pretpostavlja se i postojanje nekoliko kastela između njih. Iako su ti kasteli poznati iz antičkih literarnih izvora, a njihovo postojanje potvrđuju nalazi epigrafskih spomenika, oni nikada nisu arheološki iskopavani te je njihove točne lokacije još uvijek potrebno precizno odrediti. Zbog navedenog stanja istraženosti kao prvi metodološki korak istraživanja planirano je proučavanje antičkih literarnih izvora, rimskih epigrafskih spomenika, ali i, za određivanje rimskih vojnih nalazišta iznimno važna, analiza arheoloških nalaza. Pri tome su uz arheološke nalaze iz tekućih istraživanja od velikog značenja i slučajni nalazi koji su kao poklon ili otkup dospjeli u različite muzeje i zbirke, neobjavljeni slučajni nalazi iz privatnih zbirki te nalazi iz neobjavljenih istraživanja. Za određivanje rimskih vojnih nalazišta ponajprije su naravno značajni epigrafski spomenici koji spominju rimske vojne postrojbe te nalazi rimske vojne opreme i naoružanja. Za dataciju i razumijevanje pojedinih nalazišta od velikog su značenja i *instrumenta inscripta*. Na ovome mjestu donosimo pregled sitnih arheoloških nalaza s natpisima – tegula, amfora, sigilatnih proizvoda, ostalih predmeta od keramike, stakla, gema, kosti, fibula i ostalih predmeta od metala – koji potječu s područja rimskoga legijskog logora Tilurija. Dijelom se radi o nalazima iz sustavnih arheoloških istraživanja koje Odsjek za arheologiju Filozofskog fakulteta Sveučilišta u Zagrebu pod vodstvom red. prof. dr. sc. Mirjane Sanader na tom nalazištu provodi od 1997. god.² Dijelom se pak

INTRODUCTION

The Archaeology Department of the University of Zagreb Faculty of Humanities and Social Sciences, as part of the Croatian Science Foundation’s project IP-2018-01-4934, “Understanding Roman Borders: The Case of the Eastern Adriatic” (AdriaRom), is conducting research into the archaeological remains of Roman military architecture in the hinterland of Iader and Salona in order to ascertain whether or not these structures were components of a defensive border.¹ For the purpose of conducting this research, test areas were chosen (the surroundings of the Roman legionary fortresses of *Burnum* and *Tilurium*, as well as the surroundings of the presumed forts (*castella*) of *Promona*, *Magnum* and *Andetrium*) and a seven-step methodological approach was adopted. The successful reconstruction of the defensive border first requires the establishment of the positions which may be assumed to have been military sites and then the formulation of structural indicators (roads, legionary fortresses, forts and sentry towers, moats, palisades, etc.). Two legionary fortresses (*Burnum* and *Tilurium*) are known in the hinterland of Iader and Salona, and the existence of several forts between them has been presumed. Even though these forts are known from Roman-era literary sources, and their existence is backed by finds of epigraphic monuments, they were never archeologically excavated and their precise locations have yet to be pinpointed. Due to this current state of research, there are plans to study Classical literary sources and Roman epigraphic monuments, but also analyse archaeological finds, which will be extremely vital in order to determine Roman military sites. For the latter task, besides archaeological finds from ongoing excavations, chance finds that found their ways to museums and collections as gifts or purchases, unpublished finds from private collections and finds from unpublished excavations are also quite significant. Epigraphic sources that mention Roman military contingents and finds of Roman military gear and weapons are naturally the most important for ascertaining the location of Roman military sites. Also highly significant to dating and understanding the sites are *instrumenta inscripta*. Here we shall provide an overview of small archaeological finds with inscrip-

-
- 1 Ovaj rad financirala je Hrvatska zaklada za znanost projektom IP-2018-01-4934 “Razumijevanje rimskih granica: primjer istočnog Jadrana” (AdriaRom). Rad je nadopunjeno i prošireno izlaganje koje je D. Tončinić pod naslovom *Instrumenta Tiluriensia* održao na VI *Incontro instrumenta inscripta. Le iscrizioni con funzione didascalico-esplicativa* *Committente, destinatario, contenuto e descrizione dell’oggetto nell’instrumentum inscriptum*, Aquileia, 26. – 28. ožujka 2015. god. Zahvaljujemo uredništvu i recenzentima na primjedbama i sugestijama čije je uvažavanje pridonijelo kvaliteti ovog rada.
 - 2 Sanader 1998, str. 243-255; Sanader 1999, str. 75-85; Sanader 2000,

-
- 1 This paper has been fully supported by the Croatian Science Foundation under project IP-2018-01-4934 “Understanding Roman Borders: the Case of the Eastern Adriatic” (AdriaRom). The paper is a supplemented and expanded version of the paper delivered by Domagoj Tončinić under the title “*Instrumenta Tiluriensia*” at VI *Incontro instrumenta inscripta. Le iscrizioni con funzione didascalico-esplicativa* *Committente, destinatario, contenuto e descrizione dell’oggetto nell’instrumentum inscriptum*, Aquileia, 26-28 March 2015. We would like to thank the editorial board and peer reviewers for their comments and suggestions which greatly contributed to this paper’s quality.

radi o nalazima koji su danas pohranjeni u Muzeju triljskog kraja u Trilju, Muzeju Cetinske krajine u Sinju, Arheološkoj zbirci Franjevačkog samostana u Sinju, Arheološkom muzeju u Splitu ili su zabilježeni u starijoj literaturi.

TILURIUM

U Tiluriju su na nadgrobni spomenicima i drugim natpisima potvrđene različite rimske vojne postrojbe – *legio VII*, odnosno *VII Claudia pia fidelis*, *legio XI*, odnosno *XI Claudia pia fidelis*, *legio III Flavia felix*, *cohors II Cyrrhestarum*, *ala Claudia nova*, *ala (Tungrorum) Frontoniana*, *cohors I Belgarum*, *cohors III Alpinorum* i *cohors VIII voluntariorum civium Romanorum*, a uz Tilurij se veže i *cohors Aquitanorum*, koja je potvrđena u Hrvacama.³ Među navedenim postrojbama s najvećim je brojem natpisa zastupljena *legio VII*, odnosno *legio VII Claudia pia fidelis*, što je već zarana dovelo do zaključka da se upravo u Tiluriju nalazio legijski logor te legije.⁴ Većina autora smatra da je VII. legija u Dalmaciju, pa time i u Tilurij došla u vrijeme ili neposredno nakon ustanka Batona (*Bellum Batonianum*).⁵ Najstariji pouzdan datirani spomenik VII. legije u Dalmaciji su *Tabulae Dolabellae*, koje su temeljem carske titulature datirane u 16./17. odnosno 18./19. god. Na osnovi paleografskih sličnosti tri se nadgrobna spomenika s epigramima iz Tilurija mogu datirati u 1. – 3. desetljeće 1. st. po. Kr.⁶ Zbog lojalnosti koju je VII. legija pokazala u vrijeme urote namjesnika rimske provincije Dalmacije Lucija Aruncija Kamila Skribonijana protiv cara Klaudija, u vrijeme njezina boravka u Tiluriju dodijeljen joj je počasni naslov *Claudia pia fidelis*. Nakon što je *legio VII Claudia pia fidelis* između sredine 40-ih i početka 60-ih godina 1. st. premještena u Viminacij (*Viminatium*) u provinciji Meziji, u Tiluriju su, sudeći po natpisima, bile smještene pomoćne postrojbe i možda veksilacije drugih legija. Posljednja pomoćna vojna postrojba iz Tilurija odlazi nakon 245. god.⁷ Čini se da Tilurij poslije toga nije prerastao u veće antičko naselje.⁸ No život poslije toga zasigurno nije ni stao. Dva beneficijarijska žrtvenika potvrđuju da je i prije odlaska posljednje pomoćne vojne postrojbe u blizini Tilurija postojala beneficijarijska postaja (*statio*).⁹ Budući da

tions (tegulae, amphorae and *terra sigillata* products), other items made of ceramic and glass, gems, bones, fibulae and other metallic items from the area of the Roman legionary fortress of Tilurium. In part, these are finds yielded by systematic archaeological excavations that the Archaeology Department of the University of Zagreb Faculty of Humanities and Social Sciences conducted at this site since 1997 under the leadership of Prof. Mirjana Sanader, Ph.D.² Another part includes finds that are today stored in the Trilj Regional Museum in Trilj, the Cetina Territorial Museum in Sinj, the Franciscan Monastery Collection in Sinj and the Archaeological Museum in Split, or recorded in the older scholarly literature.

TILURIUM

A variety of Roman military units have been confirmed in Tilurium based on gravestones and other inscriptions: *Legio VII*, and *Legio VII Claudia pia fidelis*, *Legio XI* and *Legio XI Claudia pia fidelis*, *Legio III Flavia felix*, *Cohors II Cyrrhestarum*, *Ala Claudia nova*, *Ala (Tungrorum) Frontoniana*, *Cohors I Belgarum*, *Cohors III Alpinorum* and *Cohors VIII voluntariorum civium Romanorum*, while *Cohors Aquitanorum*, which has been confirmed in Hrvace, is also associated with Tilurium.³ Among these units, *Legio VII* and *Legio VII Claudia pia fidelis* appear in the highest number of inscriptions, which led to the rather early conclusion that the legionary fortress of this legion was in fact located in Tilurium.⁴ Most scholars believe that the Seventh Legion came to Dalmatia, and thus to Tilurium, during or immediately after the Great Illyrian Revolt (*Bellum Batonianum*).⁵ The oldest reliably dated monument to *Legio VII* in Dalmatia is the *Tabulae Dolabellae*, which based on the imperial titulary, has been dated to 16/17 or 18/19 AD. Based on palaeographic similarities, three gravestones with epigrams from Tilurium may be dated from the first to third decades of the 1st century AD.⁶ Due to the loyalty that *Legio VII* demonstrated at the time of the revolt against Emperor Claudius by the governor of Dalmatia *Lucius Arruntius Camillus Scribonianus*, during its stay in Tilurium it was awarded with the honorary title

str. 51-62; Sanader 2001, str. 183-194; Sanader 2002a, str. 87-97; Sanader 2003; Sanader, Tončinić 2003, str. 87-94; Sanader et al. 2005, str. 221-245; Sanader et al. 2014; Sanader et al. 2017; Sanader et al. 2019.

3 Za detaljniji pregled rimskih vojnih natpisa u Tiluriju vidi Sanader, Tončinić 2010, str. 34-37; Sanader, Tončinić 2013, str. 412-413.

4 Ritterling 1925, kol. 1616-1617; Betz 1939, str. 8-9; Sanader, Tončinić 2010, str. 38; Tončinić 2011, str. 172; Sanader, Tončinić 2013, str. 414.

5 Za pregled autora i mišljenja vidi Tončinić 2011, str. 11-14.

6 Sanader et al. 2013, str. 489.

7 Zaninović 1996, str. 286; Urbanc 2012, str. 219.

8 Sanader, Tončinić 2013, str. 419; Sanader et al. 2014, str. 16.

9 Schallmayer et al. 1990, br. 489 i 490.

2 Sanader 1998, pp. 243-255; Sanader 1999, pp. 75-85; Sanader 2000, pp. 51-62; Sanader 2001, pp. 183-194; Sanader 2002a, pp. 87-97; Sanader 2003; Sanader, Tončinić 2003, pp. 87-94; Sanader et al. 2005, pp. 221-245; Sanader et al. 2014; Sanader et al. 2017; Sanader et al. 2019.

3 For a detailed overview of Roman military inscriptions in Tilurium, see Sanader, Tončinić 2010, pp. 34-37; Sanader, Tončinić 2013, pp. 412-413.

4 Ritterling 1925, col. 1616-1617; Betz 1939, pp. 8-9; Sanader, Tončinić 2010, p. 38; Tončinić 2011, p. 172; Sanader, Tončinić 2013, p. 414.

5 For an overview of these scholars and their views, see Tončinić 2011, pp. 11-14.

6 Sanader et al. 2013, p. 489.

su žrtvenici nađeni u koritu rijeke Cetine, pretpostavlja se da se postaja nalazila uz rimski most u naselju koje je u izvorima poznato kao *Pons Tiluri* (*Itin. Ant.*, 337,5) ili *Ponteluri* (*Rav.*, IV, 16).¹⁰ Nalaze koji se u Tiluriju mogu datirati u razdoblje nakon odlaska posljednje pomoćne vojne postrojbe svakako treba promatrati u kontekstu ceste na kojoj su se nalazili spomenuta beneficijarijska postaja i naselje.

Na ovome mjestu valja istaknuti i mišljenja da je i prije VII. legije u Tiluriju već boravila rimska vojska. Ta mišljenja proizlaze iz analize povijesnih izvora, ali i pojedinačnih nalaza. Tako postoji mišljenje da je prije VII. legije u Tiluriju mogla boraviti *legio IX Hispana*.¹¹ Ta se pretpostavka zasniva na čitanju natpisa na steli Seksta Kornelija, kojeg pojedini autori smatraju pripadnikom te legije.¹² No osim što je čitanje natpisa sporno, valja naglasiti da ni u Tiluriju, ni u čitavoj provinciji Dalmaciji nije dokumentiran nijedan drugi spomenik IX. legije.¹³ Prema drugom mišljenju, koje se zasniva na novom čitanju stele Seksta Kornelija i Gaja Parpirija, mogućeg pripadnika VII. legije, obojica su bili pripadnici XX. legije, koja je u vrijeme ustanka Batona boravila u Tiluriju, budućem logoru VII. legije.¹⁴ Analize povijesnih izvora i zbivanja boravak rimske vojske u Tiluriju datiraju još ranije. Cijeli niz autora smatra da su legijski logori *Tilurium* i *Burnum*, zajedno s pretpostavljenim kastelima *Promona*, *Magnum*, *Andetrium* i Gračine u Humcu kod Ljubuškog, tvorili neku vrstu rimskog limesa protiv Delmata. Pojedini autori nastanak tog limesa datiraju u vrijeme ustanka Batona 6. – 9. god.¹⁵, drugi u razdoblje nakon Oktavijanova ilirskog rata 35. – 33. god. pr. Kr., odnosno prije Tiberijevog panonskog rata 12. – 10. god. pr. Kr.¹⁶, a treći već u vrijeme Oktavijanova ilirskog rata.¹⁷ Mirjana Sanader nastanak limesa datira na početak 1. st. po. Kr., ali na pozicijama koje je rimska vojska prethodno već koristila.¹⁸ S obzirom na različite prijedloge datacije valja istaknuti da najstariji rimski vojni nalazi iz arheoloških istraživanja u Tiluriju potvrđuju nazočnost rimske vojske već u vrijeme

Claudia pia fidelis. After Legio VII *Claudia pia fidelis* was transferred to Viminacium in the province of Moesia between the mid-40s and early 60s in the 1st century, based on the inscriptions, auxiliary units and possibly the provisional detachments from other legions (*vexillatia*) were stationed in Tilurium. The last auxiliary unit left Tilurium after 245 AD.⁷ It would appear that thereafter Tilurium did not grow into a larger Roman-era settlement.⁸ But life after that did not stop. Two altars of *beneficarii* confirm that even prior to the departure of the auxiliary units there was a beneficiary station (*statio*) in the vicinity of Tilurium.⁹ Since the altars were found in the Cetina River's bed, it is assumed that the station was next to the Roman bridge leading to the settlement known from the sources as *Pons Tiluri* (*Itin. Ant.*, 337,5) or *Ponteluri* (*Rav.*, IV, 16).¹⁰ The finds from Tilurium that can be dated to the period after the departure of auxiliary military units should certainly be viewed within the context of the road on which the aforementioned beneficiary station and settlement were located.

Here it would be worthwhile to emphasize that the Roman army was stationed in Tilurium even prior to the arrival of Legio VII. This view is based on an analysis of historical sources, but also individual finds. Thus, in the opinion of some scholars, prior to Legio VII, Legio IX *Hispania* may have been posted in Tilurium.¹¹ This hypothesis is based on the reading of the inscription on the stele of *Sextus Cornelius*, who was, according to certain scholars, a member of this legion.¹² But overlooking the fact that such a reading of that inscription is disputable, it is worth underscoring that no other monuments mentioning Legio IX have been documented in Tilurium, nor anywhere else in the entire province of Dalmatia.¹³ According to another opinion, which is based on a new reading of the stelae of *Sextus Cornelius* and *Gaius Parpirius* (a potential member of Legio VII), both were members of Legio XX, which was stationed in Tilurium, the future fortress of Legio VII, at the time of the Great Illyrian Revolt.¹⁴ An analysis of historical sources and

10 Zaninović 2007, str. 183; Glavaš 2016, str. 23-24.

11 Zaninović 1996, str. 284.

12 CIL III 13977; Ritterling 1925, kol. 1665 natpis pripisuje IX. legiji i datira u vrijeme cara Augusta, a Betz 1939, str. 52 i 72, kat. br. 233, natpis navodi na popisu mogućih spomenika IX. legije.

13 Tako Bulić 1894, str. 5, br. 4 (1983) natpis ne čita kao vojni; Wilkes 1969, str. 461, ga donosi na popisu spomenika VII. ili XI. legije; Alföldy 1968, kol. 1265 navodi da se navodna oznaka devete legije može čitati i kao nepoznati domus; Zaninović 1996, str. 284, upozorava na oba mišljenja; Fadić 1997, str. 80 natpis donosi na popisu mogućih spomenika VII. legije. Usporedi Sanader, Tončinić 2010, str. 45; Sanader, Tončinić 2013, str. 416.

14 Cesarik 2020; str. 149-154.

15 Wilkes 1969, str. 91-92; Wilkes 1977, str. 245-246.

16 Patsch 1914, str. 157-159; Veith 1914, str. 111-112; Patsch 1915, str. 33-34.

17 Usporedi Šašel 1974; Šašel 1992; Šašel Kos 1997; Šašel Kos 2005.

18 Sanader 2002b; Sanader 2002c.

7 Zaninović 1996, p. 286; Vrbanc 2012, p. 219.

8 Sanader, Tončinić 2013, p. 419; Sanader *et al.* 2014, p. 16.

9 Schallmayer *et al.* 1990, no. 489 and 490.

10 Zaninović 2007, p. 183; Glavaš 2016, pp. 23-24.

11 Zaninović 1996, p. 284.

12 CIL III 13977; Ritterling 1925, col. 1665 attributed the inscription to Legio IX and dated it to the reign of Augustus, while Betz 1939, pp. 52 and 72, cat. no. 233, cited the inscription in the list of possible monuments of Legio IX.

13 Thus Bulić 1894, p. 5, no. 4 (1983) did not read the inscription as military; Wilkes 1969, p. 461, cited it in a list of monuments of Legio VII or XI; Alföldy 1968, col. 1265 stated that the apparent designation of the Ninth Legion may also be read as an unknown *domus*; Zaninović 1996, p. 284, highlighted both opinions; Fadić 1997, p. 80 included the inscription on the list of potential monuments of Legio VII. Cf. Sanader, Tončinić 2010, p. 45; Sanader, Tončinić 2013, p. 416.

14 Cesarik 2020; pp. 149-154.

kasne Republike.¹⁹ Oni su jasan pokazatelj da je rimska vojska taj položaj koristila znatno prije ustanka Batona i vremena u kojem je prema većini autora VII. legija došla u Dalmaciju, odnosno Tilurij.²⁰

PEČATI NA TEGULAMA (TAB. 1; T. 1)

U dosadašnjim istraživanjima rimskoga legijskog logora Tilurija dokumentirano je 13 pečata pet rimskih vojnih postrojba. Pečati pripadaju VII. legiji *Claudia pia fidelis*, XI. legiji *Claudia pia fidelis*, IIII. legiji *Flavia felix*, III. kohorti *Alpinorum* i VIII. kohorti *voluntariorum civium Romanorum* (tab. 1).

VII. legija *Claudia pia fidelis*

Tri pečata pripadaju VII. legiji *Claudia pia fidelis*. Od toga dva potječu iz arheoloških iskopavanja u Tiluriju i danas se čuvaju u Muzeju triljskog kraja (tab. 1. 1-2; T. 1. 1-2), a jedan se čuva u Muzeju Cetinske krajine, kamo je dospio kao otkup od Petra Tadinca iz Garduna (tab. 1. 3; T. 1. 3).²¹ Osim navedena tri, na području rimske provincije Dalmacije poznato je još svega 13 pečata ove postrojbe.²² Dva se također čuvaju u Muzeju Cetinske krajine i oba su slučajno nalaz s područja Čitluka (*Aequum*).²³ Jedanaest pečata čuva se u Arheološkoj zbirci Franjevačkog samostana u Sinju.²⁴ Za samo jedan od njih sačuvan je podatak da potječe iz Hrvaca kod Sinja, ali se uz njega navodi da tri pečata potječu iz tog mjesta, a jedan do dva pečata iz Čitluka.²⁵ Taj podatak navodi na zaključak da barem dio od preostalih 10 pečata također potječe iz Ekva. Za preostale pečate iz Arheološke zbirke Franjevačkog samostana može se opravdano pretpostaviti da također potječu iz Ekva, ali se Tilurij kao moguće nalazište također ne može isključiti.²⁶ Pečati uglavnom imaju oblik *tabulae ansatae* sa zaobljenim ili polukružnim ansama, a na pojedinim primjercima se u ansama javlja stilizirana grančica. Slovo G moguće je interpretirati i kao slova *Cl* u ligaturi što izgleda kao naopako slovo *D*. Između slova *C* i *P* nalazi se točka u funkciji razdjelnice, dok između slova *P* i *F* to nije uvijek slu-

events places the Roman army's stay in Tilurium even earlier. An entire series of scholars believes that the legionary fortresses of Tilurium and Burnum, together with the assumed forts of *Promona*, *Magnum*, *Andetrium* and Gračine in Humac, near Ljubuški, formed some sort of Roman *limes* against the *Delmatae*. Individual scholars date the emergence of this *limes* to the time of the Great Illyrian Revolt in 6-9 AD¹⁵, others to the period after Octavian's Illyrian war of 35-33 BC, i.e., prior to Tiberius' Pannonian war of 12-10 BC¹⁶, and the third to the time of Octavian's Illyrian war¹⁷. Mirjana Sanader dated the emergence of the *limes* to the beginning of the 1st century AD, but at a position already previously used by the Roman army.¹⁸ Given the differing suggestions for its dating, it would be worthwhile to point out that the oldest Roman military finds discovered during archaeological excavations in Tilurium confirm the presence of the Roman army already at the time of the late Republic.¹⁹ They are a clear indicator that the Roman army exploited this position considerably earlier than Bato's revolt and the time in which most scholars contend that Legio VII arrived in Dalmatia, in Tilurium specifically.²⁰

STAMPS ON TEGULAE (TAB. 1; PL. 1)

In previous excavations at the Roman legionary fortress of Tilurium, thirteen stamps from five Roman military units have been documented. The stamps belong to Legio VII *Claudia pia fidelis*, Legio XI *Claudia pia fidelis*, Legio IIII *Flavia felix*, Cohors III *Alpinorum* and Cohors VIII *voluntariorum civium Romanorum* (tab. 1).

Legio VII *Claudia pia fidelis*

Three stamps belong to Legio VII *Claudia pia fidelis*. Out of this, two were yielded by archaeological excavations in Tilurium and are today held in the Trilj Regional Museum (tab. 1. 1-2; Pl. 1. 1-2), while one is held in the Cetina Territorial Museum, whence it came after being purchased from Petar Tadinac from Gardun (tab. 1. 3; Pl. 1. 3).²¹ Besides these three, an additional thirteen stamps of this unit are known throughout the territory of the Roman province of Dalmatia.²² Two are also held

19 Ivčević 2017, str. 46-50.

20 Usporedi Ritterling 1925, kol. 1619; Betz 1939, str. 38; Nesselhauf 1941, str. 42; Wilkes 1969, str. 96; Zaninović 1996, str. 287; Strobel 2000, str. 515-528; Tončinić 2011, str. 14.

21 Usporedi Tončinić 2011, str. 131-133, kat. br. 112, 114 i 115.

22 Pregled nalazišta i objava vidi kod Tončinić 2009, str. 1454; Tončinić 2011, str. 123-133; Tončinić *et al.* 2011, str. 362-363. Usporedi i Wilkes 1979, str. 65-67.

23 Usporedi Tončinić 2011, str. 130-132, kat. br. 111 i 113.

24 Usporedi Tončinić 2011, str. 123-130, kat. br. 100-110.

25 Tončinić *et al.* 2011, str. 366-367, kat. br. 8; Tončinić 2011, str. 128, kat. br. 107.

26 Tončinić 2011, str. 166.

15 Wilkes 1969, pp. 91-92; Wilkes 1977, pp. 245-246.

16 Patsch 1914, pp. 157-159; Veith 1914, pp. 111-112; Patsch 1915, pp. 33-34.

17 Cf. Šašel 1974; Šašel 1992; Šašel Kos 1997; Šašel Kos 2005.

18 Sanader 2002b; Sanader 2002c.

19 Ivčević 2017, pp. 46-50.

20 Cf. Ritterling 1925, col. 1619; Betz 1939, p. 38; Nesselhauf 1941, p. 42; Wilkes 1969, p. 96; Zaninović 1996, p. 287; Strobel 2000, pp. 515-528; Tončinić 2011, p. 14.

21 Cf. Tončinić 2011, pp. 131-133, cat. no. 112, 114 and 115.

22 For an overview of sites and publications, see Tončinić 2009, p.

čaj.²⁷ Za sada ne raspoložemo podacima o fabrikatima. Ukupan broj od 16 pečata VII. legije *Claudia pia fidelis* s područja rimske provincije Dalmacije i samo tri s područja legijskog logora Tilurija samo je naizgled relativno mali broj nalaza s obzirom na činjenicu da je Tilurij bio legijski logor VII. legije za vrijeme njezina boravka u provinciji Dalmaciji. Svi se navedeni pečati mogu datirati u razdoblje između 42. god., kada je VII. legija dobila počasni naslov *Claudia pia fidelis*, i odlaska legije iz provincije Dalmacije. Različiti autori su za odlazak VII. legije iz Dalmacije predložili različite datume i okolnosti. Najranija predložena mogućnost odlaska u Meziju je 45. god., kada je Rimskom Carstvu pripojena Trakija. To se mišljenje među ostalim zasniva i na relativno malom broju spomenika VII. legije *Claudia pia fidelis* u provinciji Dalmaciji. John J. Wilkes je uz to upozorio na činjenicu kako je rani odlazak mogao biti i posljedica Skribonianove urote, odnosno opasnosti koju su za cara Klaudija predstavljale dvije legije u Dalmaciji.²⁸ Sljedeći mogući datum i okolnost su 56./57. god., kada je VII. legija u provinciji Meziji mogla zauzeti mjesto III. legije *Scythicae*, koja je premještena u Armeniju.²⁹ Na kraju, u obzir još dolazi i 61. god., kada je VII. legija u provinciji Meziji mogla zauzeti mjesto V. legije *Macedonica* koja je također premještena na Istok.³⁰ Proizvodnja tegula s pečatima VII. legije *Claudia pia fidelis* dakle nije mogla trajati ni 20 godina, a datirati se može oko sredine 1. st. Osim potreba u vlastitom logoru ona je vjerojatno podmirila i potrebe javnih građevinskih radova u Ekvu.

XI. legija *Claudia pia fidelis*

Četiri pečata iz Tilurija pripadaju XI. legiji *Claudia pia fidelis*. Jedan potječe iz arheoloških iskopavanja u Tiluriju i danas se čuva u Muzeju triljskog kraja (tab. 1. 4; T. 1. 4), a tri se čuvaju u Muzeju Cetinske krajine, gdje su dospjeli kao otkup od Petra Tadinca iz Garduna (tab. 1. 5-7; T. 1. 5-7).³¹ U starijoj literaturi spominje se jedan pečat XI. legije *Claudia pia fidelis* na opeki za hipokaust koja je nađena u Dolcu kod Trilja, a vjerojatno je riječ o istoj opeki koju Patsch i drugi autori kasnije spominju kao nalaz iz Tilurija.³² Na istome mjestu Patsch spominje još jedan pečat legije, koji se ne može sa sigurnošću označiti kao nalaz iz Tilurija.³³ Osim u Tiluriju, odnosno Dolcu pečati XI. legije *Clau-*

in the Cetina Territorial Museum and both are chance finds from the area of Čitluk (Aequum).²³ Eleven stamps are held in the Franciscan Monastery Archaeological Collection in Sinj.²⁴ For only one there are data that it originated in Hrvace, at Sinj, but besides that there is information that three stamps originated in the same place, and that one to two stamps are from Čitluk.²⁵ This information points to the conclusion that at least a part of the remaining ten stamps also originally came from Aequum. One may justifiably presume that the remaining stamps in the Franciscan Monastery Archaeological Collection are also from Aequum, although Tilurium cannot be discounted as a possible point of origin.²⁶ The stamps generally have the shape of *tabulae ansatae* with rounded or semi-circular ansae, and a stylized twig appears in the ansae of individual examples. The letter G may also be interpreted as the letters CI in ligature, which resembles a backward letter D. Between the letters C and P there is a dot that serves as a punctuation mark, while this is not always the case between the letters P and F.²⁷ Thus far there are no data on finished products. The total number of sixteen stamps of Legio VII *Claudia pia fidelis* from the territory of the Roman province of Dalmatia, and the three from the area of the legionary fortress of Tilurium only seems like a relatively small number of finds given the fact that Tilurium was the fortress of Legio VII during its stay in the province of Dalmatia. All of these stamps may be dated to the period between 42 AD, when Legio VII acquired the honorary title *Claudia pia fidelis*, to the legion's departure from the province of Dalmatia. Different scholars have proposed different dates and circumstances for the departure of Legio VII from Dalmatia. The earliest proposed possibility for their departure to Moesia was 45 AD, when Thrace was annexed to the Roman Empire. This opinion is, however, based on a relatively small number of monuments of Legio VII *Claudia pia fidelis* in the province of Dalmatia. John J. Wilkes further stressed the fact that an early departure may have been a consequence of intrigues on the part of Scribonianus, i.e., the threat that two legions in Dalmatia would have been to Emperor Claudius.²⁸ The next potential date and circumstance were 56/57 AD, when Legio VII could have come to Moesia to take the place of Legio III *Scythicae*, which was transferred to

27 Usporedi Tončinić 2011, str. 123-133; Tončinić *et al.* 2011, str. 362-363 i 365-371, kat. br. 1-11, 15-17, 26-27.

28 Nesselhauf 1941, str. 42; Wilkes 1969, str. 96; Zaninović 1996, str. 287; Tončinić 2011, str. 14.

29 Ritterling 1925, kol. 1619; Strobel 2000, str. 515-528; Tončinić 2011, str. 14.

30 Betz 1939, str. 38; Tončinić 2011, str. 14.

31 Tončinić *et al.* 2011, str. 396-371, kat. br. 18-20 i 28.

32 Bulić 1891, str. 117, br. 401 = AMS Fa-401; Patsch 1898, col. 123, sl. 37. Usporedi Patsch 1900, str. 78 i Betz 1939, str. 22 i 26.

33 Patsch 1900, str. 78, br. 7, sl. 50 = Bulić 1895, str. 219, br. 507 = AMS Fa-507 za koju Bulić navodi "di provenienza dalmata, ma di

1454; Tončinić 2011, pp. 123-133; Tončinić *et al.* 2011, pp. 362-363. Cf. also Wilkes 1979, pp. 65-67.

23 Cf. Tončinić 2011, pp. 130-132, cat. no. 111 and 113.

24 Cf. Tončinić 2011, pp. 123-130, cat. no. 100-110.

25 Tončinić *et al.* 2011, pp. 366-367, cat. no. 8; Tončinić 2011, p. 128, cat. no. 107.

26 Tončinić 2011, p. 166.

27 Cf. Tončinić 2011, pp. 123-133; Tončinić *et al.* 2011, pp. 362-363 and 365-371, cat. no. 1-11, 15-17, 26-27.

28 Nesselhauf 1941, p. 42; Wilkes 1969, p. 96; Zaninović 1996, p. 287; Tončinić 2011, p. 14.

dia pia fidelis potvrđeni su i u Burnu, logoru te legije u rimskoj provinciji Dalmaciji, u provincijskom središtu Saloni, na Bribiru (*Varvaria*) i u Dubravicama.³⁴ Tilurijski primjerci pripadaju poznatoj varijanti pečata jednostavnog pravokutnog oblika,³⁵ a s analizama za usporedbu fabrikata za sada ne raspolažemo.³⁶ Stotinjak objavljenih ili u literaturi spomenutih pečata ove legije u provinciji Dalmaciji uvelike nadmašuje one VII. legije *Claudia pia fidelis*, a to se samo djelomično može objasniti njezinim dužim boravkom u Dalmaciji. Pečati XI. legije *Claudia pia fidelis* mogu se također datirati u razdoblje između 42. god., kada je i XI. legija dobila počasni naslov *Claudia pia fidelis*, i njezinog odlaska iz provincije Dalmacije za vrijeme građanskoga rata 69. god.³⁷ Proizvodnja je dakle dobro datirana u razdoblje između 42. i 69. godine i mogla je trajati 27 godina. XI. legija *Claudia pia fidelis* mogla je gotovo 10 godina duže proizvoditi tegule s pečatima u odnosu na VII. legiju *Claudia pia fidelis*. Osim potreba u vlastitom logoru ona je vjerojatno podmirivala i potrebe javnih građevinskih radova u Saloni i Bribiru, dok je pojedinačni nalaz u Dubravicama teško interpretirati. Pečati iz Tilurija i Dolca zanimljivi su za razumijevanje isporuke građevinskog materijala i za razumijevanje razmještaja legijskih veksilacija u provinciji Dalmaciji. Činjenica je da osim navedenih pečata u Tiluriju za sada nije dokumentiran ni jedan pouzdani nalaz XI. legije iz razdoblja poslije 42. godine.³⁸ Za razliku od toga dokumentirana su dva nadgrobna spomenika te jedna olovna plomba iz razdoblja prije 42. godine.³⁹ Patsch je temeljem navedenog zaključio da je jedna veksilacija XI. legije u Tiluriju boravila već prije 42. god. i da je ondje ostala nakon 42. godine ili da su veksilacije u Tiluriju boravile u dva navrata,

Armenia.²⁹ Finally, 61 AD may also be considered, when Legio VII could have replaced Legio V *Macedonica*, which was also transferred to the Orient.³⁰ The production of tegulae bearing the stamps Legio VII *Claudia pia fidelis* thus could not have even lasted 20 years, and it can be dated to roughly the mid-1st century. Besides meeting needs in their own fortress, it probably also supplied the needs of public construction works in Aequum.

Legio XI *Claudia pia fidelis*

Four stamps from Tilurium belong to Legio XI *Claudia pia fidelis*. One was discovered during archaeological excavations in Tilurium and today held in the Trilj Regional Museum (tab. 1. 4; Pl. 1. 4), while three are held in the Cetina Territorial Museum, whence they came after being purchased from Petar Tadinac from Gardun (tab. 1. 5-7; Pl. 1. 5-7).³¹ In the older scholarly literature there is mention of a stamp of Legio XI *Claudia pia fidelis* on a hypocaust brick that was found in Dolac, at Trilj, and was probably the same brick that Patsch and other scholars later mentioned as a find from Tilurium.³² Patsch mentioned another legionary stamp at the same site, but it cannot be designated as a find from Tilurium with any certainty.³³ Besides the Tilurium, or rather Dolac, stamps of Legio XI *Claudia pia fidelis* have also been confirmed in Burnum, this legion's fortress in the Roman province of Dalmatia, in the provincial capital of Salona, in Bribir (*Varvaria*) and Dubravece.³⁴ The Tilurium examples belong to a well-known variant of stamps with simple rectangular shape,³⁵ but thus far there are no analyses that compare their manufacture.³⁶ The roughly one hundred stamps of this legion in the province of Dalmatia either published or mentioned in the scholarly literature far exceed those of Legio

localita incerta" = CIL III 14022. CIL III 2328⁷⁹ izjednačava opeku za hipokaust Bulić 1891, str. 117, br. 401 = AMS Fa-401 = Patsch 1898, col. 123, sl. 37 i tegulu Bulić 1895, str. 219, br. 507 = AMS Fa-507 = Patsch 1900, str. 78, br. 7, sl. 50 = CIL III 14022. To mišljenje preuzeo je i Betz 1939, str. 22 i 26, ali vjerojatno se ipak radi o dva različita nalaza.

- 34 Pregled nalazišta i objava vidi kod Tončinić 2009, str. 1450-1451, i Tončinić *et al.* 2011, str. 363-364. Usporedi i Pedišić, Podrug 2007; Miletić 2011; Juras, Jurković Pešić 2016 i Borzić 2020, str. 170-172, 303, tab. 105.
- 35 Usporedi pečat oblika *a* kod Zabehticky-Scheffenegger, Kandler 1979, str. 40, tab. 21.1 i Borzić 2020, str. 170-172, 303, tab. 105.1.
- 36 Za fabrikate tegula iz Burna usporedi Borzić 2020, str. 170-172, 313, Prilog 8.
- 37 Ritterling 1925, kol. 1692; Betz 1939, str. 18, 22, 67-68, kat. br. 85, 89, 113; Zaninović 1996, str. 289; Fellmann 2000, str. 127-131; Cambi *et al.* 2007; Sinobad 2009, str. 11-12; Tončinić 2009, str. 1449.
- 38 Istina, za jedan nadgrobni spomenik može se na temelju jako oštećenog natpisa pretpostaviti da je podignut za pripadnika XI. legije *Claudia pia fidelis*, no on je u jednakoj mjeri mogao biti i pripadnik VII. legije *Claudia pia fidelis* i III. legije *Flavia felix*. Vidi Tončinić 2007, str. 263.
- 39 Za spomenike XI. legije, odnosno XI. *Claudia pia fidelis* u Tiluriju usporedi Patsch 1898; Betz 1939, str. 18, 22, 26, 67-68, kat. br. 85, 89 i 113.

- 29 Ritterling 1925, col. 1619; Strobel 2000, pp. 515-528; Tončinić 2011, p. 14.
- 30 Betz 1939, p. 38; Tončinić 2011, p. 14.
- 31 Tončinić *et al.* 2011, p. 396-371, cat. no. 18-20 and 28.
- 32 Bulić 1891, 9. 117, no. 401 = AMS Fa-401; Patsch 1898, col. 123, fig. 37. Cf. Patsch 1900, p. 78 and Betz 1939, pp. 22 and 26.
- 33 Patsch 1900, p. 78, no. 7, fig. 50 = Bulić 1895, p. 219, no. 507 = AMS Fa-507 about which Bulić said "di provenienza dalmata, ma di localita incerta" = CIL III 14022. CIL III 2328⁷⁹ equates the hypocaust brick Bulić 1891, p. 117, no. 401 = AMS Fa-401 = Patsch 1898, col. 123, fig. 37, with the tegula Bulić 1895, p. 219, no. 507 = AMS Fa-507 = Patsch 1900, p. 78, no. 7, fig. 50 = CIL III 14022. This view was also assumed by Betz 1939, pp. 22 and 26, but these are nonetheless probably two different finds.
- 34 For an overview of find sites and publications, see Tončinić 2009, pp. 1450-1451, and Tončinić *et al.* 2011, pp. 363-364. Cf. also Pedišić, Podrug 2007; Miletić 2011; Juras, Jurković Pešić 2016 and Borzić 2020, pp. 170-172, 303, tab. 105.
- 35 Cf. the *a*-shaped stamp in Zabehticky-Scheffenegger, Kandler 1979, p. 40, tab. 21.1 and Borzić 2020, pp. 170-172, 303, tab. 105.1.
- 36 On the manufacture of tegulae from Burnum, cf. Borzić 2020, pp. 170-172, 313, Exhibit 8.

prije 42. god. i nakon što je VII. legija napustila logor. Također je zaključio da je navedena veksilacija u Tiluriju proizvodila opeku i izvodila građevinske radove, a i boravak prije 42. godine mogao bi biti povezan s građevinskim radovima koje su zajedno izvodile VII. i XI. legija.⁴⁰ Pečati XI. legije *Claudia pia fidelis* iz Tilurija mogu se povezati s isporukom građevinskoga materijala, ali i s boravkom jedne veksilacije koja je nakon 42. god. u Tiluriju izvodila građevinske radove. Strogo gledano, oboje se u podjednakoj mjeri moglo dogoditi i prije i poslije odlaska VII. legije *Claudia pia fidelis* iz Tilurija. Činjenica da je VII. legija i sama proizvodila tegule, govori u prilog kasnije datacije. Nesrazmjerno veći broj pečata XI. legije u provinciji Dalmaciji možda upućuje na zaključak da je ova legija imala veću, a ne samo dužu proizvodnju i da je u Tiluriju isporukom pokrila potrebe koje VII. legija nije mogla zadovoljiti vlastitom proizvodnjom.

III. legija *Flavia felix*

Dva pečata pripadaju III. legiji *Flavia felix*. Jedan je prilikom arheoloških istraživanja u Tiluriju dokumentiran u sekundarnoj upotrebi, a drugi je zatečen u Muzeju triljskog kraja prilikom osnivanja muzeja (tab. 1. 8-9; T. 1. 8-9). Osim u Tiluriju, pečati III. legije *Flavia felix* potvrđeni su i u Burnu, logoru te legije u rimskoj provinciji Dalmaciji, Aseriji, Smrdeljima, Promoni, Andetriju, Saloni, Vitini i Gračinama kod Ljubuškog.⁴¹ Tilurijski primjerci pripadaju poznatoj varijanti pečata jednostavnoga pravokutnog oblika,⁴² a s analizama za usporedbu fabrikata za sada ne raspoložemo.⁴³ Pedesetak objavljenih ili u literaturi spomenutih pečata ovu legiju stavlja na drugo mjesto po broju nalaza u provinciji Dalmaciji, a zanimljivo je da su pečati ove legije zabilježeni na znatno većem broju nalazišta nego što je to slučaj s pečatima XI. legije *Claudia pia fidelis*. Svi pečati III. legije *Flavia felix* mogu se datirati u razdoblje između 70. god.,

VII *Claudia pia fidelis*, and this may only partially be explained by the former legion's longer stay in Dalmatia. The stamps of Legio XI *Claudia pia fidelis* may also be dated to the period between 42 AD, when Legion XI acquired the honorary title *Claudia pia fidelis*, and its departure from the province of Dalmatia during the civil war in 69 AD.³⁷ Production therefore has thus been soundly dated to the period between 42 and 69 AD and may have endured for 27 years. Legio XI *Claudia pia fidelis* may have produced stamped tegulae almost ten years longer than Legio VII *Claudia pia fidelis*. In addition to the needs of their own fortress, it probably also met the needs of public construction works in Salona and Bribir, while the isolated find in Dubravice is difficult to interpret. The stamps from Tilurium and Dolac are interesting for an understanding of the delivery of construction material and the deployment of legionary provisional detachments in the province of Dalmatia. The fact is that besides these stamps in Tilurium, thus far there is not a single reliably documented find testifying to Legio XI after 42 AD.³⁸ By contrast, two gravestones and a lead seal from the period prior to 42 AD have been documented.³⁹ Patsch thus concluded that a detachment (*vexillatio*) of Legio XI had already been posted in Tilurium prior to 42 AD and even remained there afterward, or that the detachments stayed in Tilurium twice, prior to 42 AD and then after Legio VII had left the fortress. He also concluded that this detachment manufactured bricks and engaged in construction works in Tilurium, and even its stay prior to 42 AD could be linked to construction works that were jointly conducted by Legio VII and XI.⁴⁰ The stamps of Legio XI *Claudia pia fidelis* from Tilurium may

40 Patsch 1898, kol. 124. Njegovo mišljenje prenosi Betz 1939, str. 22, a pretpostavku o boravku veksilacije XI. legije *Claudia pia fidelis* nakon odlaska VII. legije *Claudia pia fidelis* podržao je i Zaninović 1996, str. 289. Poblize neopisani zajednički radovi VII. i XI legije jasno su dokumentirani građevinskim natpisom CIL III 2908, dok *Tabulae Dolabellae* (CIL III 3198a = 10156a + CIL III 3200 = CIL III 10158) jasno navode da je Tiberije *[viam] a colonia Salonitan(a) / [ad f]in[es] provinciae Illyrici // [-----] / cuius viai millia passus sunt / CLXVII munit per vexillarios / leg(ionis) VII et XI*. Za drugu cestu, *a Salonis ad Hedum castel(lum) / Daesitiatum* (CIL III 3201 = 10159 + 3198b = 10156b.) nije navedeno tko ju je gradio. Međutim, s obzirom da je vodila preko Tilurija, vjerojatna je pretpostavka da je i nju gradila VII. legija, a veličina građevinskog zahvata možda je objašnjenje za boravak veksilacije XI. legije u Tiluriju. Usporedi Tončinić 2020, str. 193.

41 Pregled nalazišta i objava vidi kod Tončinić 2009, str. 1454; Tončinić et al. 2011, str. 364 i Borzić 2020, str. 173-173, 303, tab. 105.

42 Usporedi pečat oblika *a* kod Zabehlicky-Scheffenegger, Kandler 1979, str. 40-41, tab. 22.2 i Borzić 2020, str. 172-173, 303, tab. 105.4.

43 Za fabrikate tegula iz Burna usporedi Borzić 2020, str. 170-172, 313, Prilog 8.

37 Ritterling 1925, col. 1692; Betz 1939, pp. 18, 22, 67-68, cat. no. 85, 89, 113; Zaninović 1996, p. 289; Fellmann 2000, pp. 127-131; Cambi et al. 2007; Sinobad 2009, pp. 11-12; Tončinić 2009, p. 1449.

38 To be sure, one gravestone may, based on its quite damaged inscription, be assumed to have been raised for a member of Legio XI *Claudia pia fidelis*, but he could have just as easily been a member of Legio VII *Claudia pia fidelis* and Legio III *Flavia felix*. See Tončinić 2007, p. 263.

39 On the monuments of Legio XI and XI. *Claudia pia fidelis* in Tilurium, cf. Patsch 1898; Betz 1939, pp. 18, 22, 26, 67-68, cat. no. 85, 89 and 113.

40 Patsch 1898, col. 124. His view was cited by Betz 1939, p. 22, and the assumed stay of a detachment of Legio XI *Claudia pia fidelis* after the departure of Legio VII *Claudia pia fidelis* was further supported by Zaninović 1996, p. 289. The undescribed joint works by Legio VII and XI are clearly documented by the construction inscription CIL III 2908, while the *Tabulae Dolabellae* (CIL III 3198a = 10156a + CIL III 3200 = CIL III 10158) clearly states that Tiberius *[viam] a colonia Salonitan(a) / [ad f]in[es] provinciae Illyrici // [-----] / cuius viai millia passus sunt / CLXVII munit per vexillarios / leg(ionis) VII et XI*. As to the other road, *a Salonis ad Hedum castel(lum) / Daesitiatum* (CIL III 3201 = 10159 + 3198b = 10156b), it is not specified as to who built it. However, given that it led through Tilurium, a likely hypothesis is that it was constructed by Legio VII, and the extent of the construction undertaking may explain the stay of a detachment of Legio XI in Tilurium. Cf. Tončinić 2020, p. 193.

kada je premještena u Dalmaciju gdje je zauzela upražnjeni logor u Burnu, i 86. god., kada je premještena u Meziju.⁴⁴ Proizvodnja opeke mogla je dakle trajati 16 godina. Osim potreba u vlastitom logoru ona je vjerojatno podmirila i potrebe javnih građevinskih radova u Saloni i Aseriji. Nalazi iz Smrdelja vezani su uz samu proizvodnju opeka, a oni u Promoni, Andetriju te Vitini i Gračinama kod Ljubuškog mogu se povezati s isporukom građevinskoga materijala, ali i s boravkom jedne veksilacije u drugim vojnim logorima. Osim pečata III. legije *Flavia felix* u Tiluriju za sada nije dokumentiran ni jedan pouzdani nalaz te legije. Kao što je već spomenuto, za jedan nadgrobni spomenik može se na temelju jako oštećenog natpisa pretpostaviti da je podignut za pripadnika III. legije *Flavia felix*, međutim on je u jednakoj mjeri mogao biti i pripadnik VII. *Claudia pia fidelis* i XI. *Claudia pia fidelis*.⁴⁵ Pečati III. legije *Flavia felix* iz Tilurija otvaraju dakle mogućnost boravka jedne njezine veksilacije koja je između 70. i 86. god. u Tiluriju izvodila građevinske radove.

III. kohorta *Alpinorum*

Dva pečata pripadaju III. kohorti *Alpinorum*. Jedan potječe iz arheoloških iskopavanja u Tiluriju (tab. 1. 10; T. 1. 10) i danas se čuva u Muzeju triljskog kraja, a jedan se čuva u Muzeju Cetinske krajine, kamo je dospio kao otkup od Petra Tadinca iz Garduna (tab. 1. 11; T. 1. 11). Osim navedenih, na području rimske provincije Dalmacije nije dokumentiran ni jedan drugi pečat ove kohorte.⁴⁶ Pečat tab. 1. 11; T. 1. 11 ima jednostavan pravokutni oblik s profilacijom u obliku *tabulae ansatae*, a čini se da i drugi primjerak pripada istom tipu. Pečati se mogu datirati isključivo na osnovi pretpostavljenog razmještaja kohorte u provinciji Dalmaciji. Pretpostavlja se da je u 2. st. stalni logor ove kohorte bio u Andetriju i da je u to vrijeme jedan dio postrojbe boravio i u Tiluriju, gdje je kohorta potvrđena natpisom CIL III 14935.⁴⁷ Pečati III. kohorte *Alpinorum* u Tiluriju upućuju na zaključak da je kohorta ovdje izvodila građevinske radove.

VIII. kohorta *voluntariorum civium Romanorum*

U starijoj literaturi spominje se jedan pečat VIII. kohorte *voluntariorum civium Romanorum* koji je nađen u Tiluriju (tab. 1. 12; T. 1. 12).⁴⁸ Osim u Tiluriju njezini su pečati potvrđeni i u Andetriju, Ekvu, Splitu, Saloni i Gračinama kod Ljubuškog. U Arheološkoj zbirci Franjevačkoga samostana u Sinju uz jedan pečat koji

be tied to the delivery of construction materials, but also the stay of a detachment which carried out construction works in Tilurium after 42 AD. Strictly speaking, both could have occurred in equal measure both before and after the departure of Legio VII *Claudia pia fidelis* from Tilurium. The fact that Legio VII itself manufactured tegulae also backs the later dating. The disproportionately higher number of stamps of Legio XI in the province of Dalmatia may point to the conclusion that this legion had more voluminous and not just longer-lasting production, and that by delivery to Tilurium it covered the needs that Legio VII could not meet with its own production.

Legio III *Flavia felix*

Two stamps belong to Legio III *Flavia felix*. One was documented in secondary use during archaeological excavations in Tilurium, while the other was found in the Trilj Regional Museum when the museum was founded (tab. 1. 8-9; Pl. 1. 8-9). Besides Tilurium, stamps of Legio III *Flavia felix* have also been confirmed in Burnum, this legion's fortress in the Roman province of Dalmatia, Asseria, Smrdelji, Promona, Andetrium, Salona, Vitina and Gračine at Ljubuški.⁴¹ The Tilurium examples belong to the well-known variant of rectangular stamps,⁴² but thus far there are no analyses that compare their manufacture.⁴³ The roughly fifty stamps of this legion either published or mentioned in the scholarly literature put them in second place in the province of Dalmatia, and it is interesting that this legion's stamps have been recorded at a considerably higher number of sites than is the case for stamps of Legio XI *Claudia pia fidelis*. All stamps of Legio III *Flavia felix* may be dated to the period between 70 AD, when it was transferred to Dalmatia and took possession of the deserted fortress in Burnum, and 86 AD, when it was redeployed to Moesia.⁴⁴ Brick production may have thus proceeded for 16 years. Besides supplying the needs for their own fortress, they probably also met the needs of public construction works in Salona and Asseria. The finds from Smrdelji were tied to brick production itself, while those in Promona, Andetrium and Vitina and Gračine at Ljubuški can be tied to the delivery of construction materials, but also the stay of a detachment in other military forts. Besides the stamps of Legio III *Flavia felix* in Tilurium, thus far not a single verifiable find of this legion has been documented. As already noted, it may be assumed that one gravestone,

44 Patsch 1900, str. 79-83; Betz 1939, str. 46-48.

45 Tončinić 2007, str. 263.

46 Pregled nalazišta i objava vidi kod Tončinić 2009, str. 1454; Tončinić 2001, str. 123-133; Tončinić *et al.* 2011, str. 362-363. Za III. kohortu *Alpinorum* usporedi i Marić 2017.

47 Alföldy 1987, str. 246; Bojanovski 1988, str. 356, 367; Zaninović 1996, str. 289; Spaul 2000, str. 266-268; Tončinić 2009, str. 1454.

48 Bulić 1896, str. 151, br. 550 = AMS Fa-550.

41 For an overview of find sites and publications, see Tončinić 2009, p. 1454; Tončinić *et al.* 2011, p. 364 and Borzić 2020, pp. 173-173, 303, tab. 105.

42 Cf. the *a*-shaped stamp in Zabehlicky-Scheffenecker, Kandler 1979, pp. 40-41, tab. 22.2 and Borzić 2020, pp. 172-173, 303, tab. 105.4.

43 On the manufacture of tegulae from Burnum, cf. Borzić 2020, pp. 170-172, 313, Exhibit 8.

44 Patsch 1900, str. 79-83; Betz 1939, pp. 46-48.

	Signatura	Pečat	Datacija	Literatura
leg(ionis) VII C(laudiae) p(iae) f(idelis)				
1	MTK-932	[l]eg(ionis) VII [C(laudiae) p(iae) f(idelis)]	nakon 42. god. po. Kr.	Tončinić 2011, str. 132, kat. br. 114.
2	MTK-1705	[leg(ionis)] VII C(laudiae)[p(iae) f(idelis)]	nakon 42. god. po. Kr.	Tončinić 2011, str. 132-133, kat. br. 115.
3	MCK-AZ-301	leg(ionis) VII C(laudiae) p(iae) f(idelis)	nakon 42. god. po. Kr.	Tončinić 2011, str. 131, kat. br. 112.
leg(ionis) XI C(laudiae) p(iae) f(idelis)				
4	MTK-1708	[le]g(ionis) XI C(laudiae) [p(iae) f(idelis)]	42. - 69. god. po. Kr.	Tončinić <i>et al.</i> 2011, str. 371, kat. br. 28.
5	MCK-AZ-296	[l]eg(ionis) XI C(laudiae) p(iae) f(idelis)	42. - 69. god. po. Kr.	Tončinić <i>et al.</i> 2011, str. 369, kat. br. 18.
6	MCK-AZ-297	leg(ionis) X[I C(laudiae) p(iae) f(idelis)]	42. - 69. god. po. Kr.	Tončinić <i>et al.</i> 2011, str. 369, kat. br. 19.
7	MCK-AZ-298	leg(ionis) XI C(laudiae) [(p(iae) f(idelis)]	42. - 69. god. po. Kr.	Tončinić <i>et al.</i> 2011, str. 369, kat. br. 20.
leg(ionis)-IIII F(laviae) f(elix)				
8		leg(ionis)-IIII [F(laviae) f(elix)]	70. - 86. god. po. Kr.	Tončinić <i>et al.</i> 2011, str. 370, kat. br. 24.
9	MTK-147	leg(ionis)-IIII [F(laviae) f(elix)]	70. - 86. god. po. Kr.	Tončinić <i>et al.</i> 2011, str. 370, kat. br. 23.
Coh(ortis) III Alp(inorum)				
10	MTK-933	Coh(ortis) III Alp(inorum)	2. st. po. Kr.	Tončinić <i>et al.</i> 2011, str. 370, kat. br. 25.
11	MCK-AZ-300	[Co]h(ortis) III A[lp(inorum)]	2. st. po. Kr.	Tončinić <i>et al.</i> 2011, str. 369, kat. br. 21.
12	AMS-Fa-550	C(o)hor(tis) VIII vo[l(untariorum)]	2. - 3. st. po. Kr.	CIL III 10182; Urbanc 2012, str. 65, kat. br. 44.
13	MCK-AZ-303	Coh(ortis) [---]	2. - 3. st. po. Kr.	Tončinić <i>et al.</i> 2011, str. 369, kat. br. 22.

	Signature	Stamp	Dating	Literature
leg(ionis) VII C(laudiae) p(iae) f(idelis)				
1	MTK-932	[l]eg(ionis) VII [C(laudiae) p(iae) f(idelis)]	after 42 AD	Tončinić 2011, p. 132, cat. no. 114.
2	MTK-1705	[leg(ionis)] VII C(laudiae)[p(iae) f(idelis)]	after 42 AD	Tončinić 2011, p. 132-133, cat. no. 115.
3	MCK-AZ-301	leg(ionis) VII C(laudiae) p(iae) f(idelis)	after 42 AD	Tončinić 2011, p. 131, cat. no. 112.
leg(ionis) XI C(laudiae) p(iae) f(idelis)				
4	MTK-1708	[le]g(ionis) XI C(laudiae) [p(iae) f(idelis)]	42-69 AD	Tončinić <i>et al.</i> 2011, p. 371, cat. no. 28.
5	MCK-AZ-296	[l]eg(ionis) XI C(laudiae) p(iae) f(idelis)	42-69 AD	Tončinić <i>et al.</i> 2011, p. 369, cat. no. 18.
6	MCK-AZ-297	leg(ionis) X[I C(laudiae) p(iae) f(idelis)]	42-69 AD	Tončinić <i>et al.</i> 2011, p. 369, cat. no. 19.
7	MCK-AZ-298	leg(ionis) XI C(laudiae) [(p(iae) f(idelis)]	42-69 AD	Tončinić <i>et al.</i> 2011, p. 369, cat. no. 20.
leg(ionis)-IIII F(laviae) f(elix)				
8		leg(ionis)-IIII [F(laviae) f(elix)]	70-86 AD	Tončinić <i>et al.</i> 2011, p. 370, cat. no. 24.
9	MTK-147	leg(ionis)-IIII [F(laviae) f(elix)]	70-86 AD	Tončinić <i>et al.</i> 2011, p. 370, cat. no. 23.
Coh(ortis) III Alp(inorum)				
10	MTK-933	Coh(ortis) III Alp(inorum)	2nd c. AD	Tončinić <i>et al.</i> 2011, p. 370, cat. no. 25.
11	MCK-AZ-300	[Co]h(ortis) III A[lp(inorum)]	2nd c. AD	Tončinić <i>et al.</i> 2011, p. 369, cat. no. 21.
12	AMS-Fa-550	C(o)hor(tis) VIII vo[l(untariorum)]	2nd- 3rd c. AD	CIL III 10182; Urbanc 2012, p. 65, cat. no. 44.
13	MCK-AZ-303	Coh(ortis) [---]	2nd- 3rd c. AD	Tončinić <i>et al.</i> 2011, p. 369, cat. no. 22.

Tablica 1.

Pečati na građevinskoj keramici iz Tilurija

Table 1.

Stamps on ceramic building material from Tilurium

potječe iz Ekva čuvaju se i dva primjerka za koje nije poznato mjesto nalaza.⁴⁹ Za ta dva primjerka se, kao i u slučaju pečata VII. legije *Claudia pia fidelis* iz iste zbirke, može opravdano pretpostaviti da potječu iz Ekva, ali se Tilurij kao moguće nalazište također ne može isključiti. Dvadeset tri objavljena ili u literaturi spomenuta pečata ovu kohortu stavljaju na prvo mjesto među pomoćnim postrojbama po broju nalaza u provinciji Dalmaciji. Međutim s obzirom na duljinu boravka ove kohorte u provinciji Dalmaciji taj broj i nije velik. Pečati se i u slučaju ove kohorte mogu datirati ponajprije na osnovi pretpostavljenog razmještaja kohorte u provinciji Dalmaciji. Pretpostavlja se da je tijekom 1. st. stalni logor ove kohorte bio u Andetriju, a od kraja 1. ili sredine 2. st. u Tiluriju i da je ondje boravila sve do sredine 3. stoljeća.⁵⁰ Osim ovim pečatom kohorta je u Tiluriju potvrđena i na pet zavjetnih spomenika, jednom građevinskom natpisu i tri nadgrobna spomenika.⁵¹ Uža datacija pečata temelji se na obliku kratice riječi *cohors*. Pečat VIII. kohorte *voluntariorum civium Romanorum* iz Tilurija ima jednostavan pravokutni oblik i može se temeljem kratice *c(o)hor(tis)* datirati u 2. – 3. stoljeće.⁵² Na sva tri spomenuta pečata iz Arheološke zbirke Franjevačkoga samostana u Sinju javlja se kratica *coh(ortis)* i oni se temeljem toga mogu datirati u 1. – 3. st.⁵³ Navedena razlika u odnosu na pečat iz Tilurija upućuje na zaključak da dva pečata za koja nam nije poznato mjesto nalaza vjerojatno potječu iz Ekva, prije nego iz Tilurija. Za sada ne raspoložemo podacima o fabrikatima.

U Muzeju Cetinske krajine čuva se još jedan pečat koji je u Muzej dospio kao otkup od Petra Tadinca iz Garduna (tab. 1. 13; T. 1. 13). Natpis *Coh(ortis)* [---] ne pruža osnove za pobližu interpretaciju i dataciju pečata. Na osnovi poznatih pečata u Tiluriju u obzir dolazi pečat III. kohorte *Alpinorum* ili VIII. kohorte *voluntariorum civium Romanorum* iz razdoblja 2. – 3. stoljeća. No oblik istina jako oštećenog pečata ne može se usporediti s oblikom pečata III. kohorte *Alpinorum*, a isto tako se kratica riječi *cohors* ne može povezati s onom na pečatu VIII. kohorte *voluntariorum civium Romanorum*.

based on a very damaged inscription, was raised for a member of Legio IIII *Flavia felix*, although he may have just as easily been a member of Legio VII *Claudia pia fidelis* or XI *Claudia pia fidelis*.⁴⁵ The stamps of Legio IIII *Flavia felix* from Tilurium thus point to the possibility that one of its detachments may have been stationed here between 70 and 86 AD and engaged in construction works in Tilurium.

Cohors III *Alpinorum*

Two stamps belong to Cohors III *Alpinorum*. One was discovered in archaeological excavations in Tilurium (tab. 1. 10; P. 1. 10) and is today held in the Trilj Regional Museum, and one is held in the Cetina Territorial Museum, whence it came after being purchased from Petar Tadinac from Gardun (tab. 1. 11; Pl. 1. 11). Besides these, no other stamps of this cohort have been documented in the Roman province of Dalmatia.⁴⁶ The stamp, tab. 1. 11; Pl. 1. 11 has a simple rectangular shape with *tabulae ansatae* moulding, and it would appear that the other example is of the same type. The stamps may be dated exclusively on the basis of the presumed transfer of the cohort to the province of Dalmatia. It is believed that in the 2nd century this cohort's permanent fort was in Andetrium and that at that time a part of the unit was also posted in Tilurium, where the cohort was confirmed by inscription CIL III 14935.⁴⁷ The stamps of Cohors III *Alpinorum* in Tilurium point to the conclusion that the cohort engaged in construction works there.

Cohors VIII *voluntariorum civium Romanorum*

A stamp of Cohors VIII *voluntariorum civium Romanorum* discovered in Tilurium (tab. 1. 12; Pl. 1. 12) is mentioned in the older scholarly literature.⁴⁸ Besides Tilurium, its stamps have been verified in Andetrium, Aequum, Split, Salona and Gračine at Ljubuški. In addition to one stamp originally from Aequum, the Franciscan Monastery Archaeological Collection in Sinj also has two stamps from an unknown find site.⁴⁹ As in the case of the stamp of Legio VII *Claudia pia fidelis* in the same collection, it may be justifiably assumed that these two stamps originated in Aequum, although Tilurium cannot be discounted as their find site. The twenty-three stamps of this cohort either published or mentioned in the scholarly literature put it in

49 Pregled nalazišta i objava vidi kod Tončinić 2009, str. 1454; Tončinić *et al.* 2011, str. 364–365. Usporedi Vrbanc 2012, str. 106–110.

50 Alföldy 1987, str. 254–255; Zaninović 1996, str. 289; Spaul 2000, str. 35–37; Matijević 2009, str. 46; Matijević 2013, str. 119.

51 Vrbanc 2012, str. 34–46, 131–133, kat. br. 22–30; Vukov 2018, str. 970–971.

52 Vrbanc 2012, str. 107 i 122, kat. br. 44.

53 Usporedi Tončinić *et al.* 2011, str. 367–368, kat. br. 12–14; Vrbanc 2012, str. 106–110, 65, 80–82, kat. br. 44, 64–66.

45 Tončinić 2007, p. 263.

46 For an overview of find sites and publications, see Tončinić 2009, p. 1454; Tončinić 2001, pp. 123–133; Tončinić *et al.* 2011, pp. 362–363. For cohors III *Alpinorum* cf. also Marić 2017.

47 Alföldy 1987, p. 246; Bojanovski 1988, pp. 356, 367; Zaninović 1996, p. 289; Spaul 2000, pp. 266–268; Tončinić 2009, p. 1454.

48 Bulić 1896, p. 151, no. 550 = AMS Fa-550.

49 For an overview of find sites and publications, see Tončinić 2009, p. 1454; Tončinić *et al.* 2011, pp. 364–365. Cf. Vrbanc 2012, pp. 106–110.

PEČATI I NATPISI NA AMFORAMA (TAB. 2; T. 2-3)

U dosadašnjim istraživanjima rimskog legijskog logora Tilurija dokumentirano je 28 različitih tipova amfora. Najveći broj primjeraka pripada amforama vinarijama (*Lamboglia 2*, *Dressel 6A*, *Pascual 1 / Dressel 1*, *Dressel 2-4*, *Camulodunum 184*, amfore ravnog dna, knidske amfore) i olearijama (*Dressel 6B*, *Dressel 20*, različiti tipovi afričkih amfora), dok su s manjim brojem primjeraka zastupljene amfore za prijevoz ribljih prerađevina (*Dressel 7-11*) i voća (*Camulodunum 189*, *Schörgendorfer 558*).⁵⁴ Pečat je utisnut na 12 ulomaka (tab. 2).

Tri pečata mogu se pripisati radionicama picenskog proizvodnog područja koje su bile u vlasništvu pripadnika gensa *Herennia*. Slova pečata utisnuta su u reljefu unutar pravokutne kartuše smještene na obodu amfora *Dressel 6A*. Restitucija *M(arci) He[r(enni)] Picenti(s)* (tab. 2. 1; T. 2. 1) i *[M(arci) Her(enni)] P[icenti(s)]* (tab. 2. 2; T. 2. 2) navodi konzula Marka Herenija Picensa kao vlasnika radionice. Pečat *MHER[---]* (tab. 2. 3; T. 2. 3) mogao bi pripadati Hereniju Picensu ili Hereniju Phaedimu. Naime, gensu *Herennia* može se pripisati nekoliko pripadnika koji su krajem 1. st. pr. Kr. i početkom 1. st. po. Kr. pečatirali amfore vinarije: *M. Herennius Picens*, konzul 34. god. pr. Kr., istoimeni sin konzul 1. god. po. Kr., kao i *M. Herennius Phaedimus* i *Herennius Priscus*, koji se najvjerojatnije mogu identificirati s obiteljskim oslobođenjima.⁵⁵ S obzirom da do sada nisu pronađene peći ili ostatci radioničkih središta, temeljem onomastičke analize i rasprostranjenosti pečata pretpostavljalo se da je radionica bila smještena na području regije *Picenum*, što je nedavno i potvrđeno arheometrijskim analizama.⁵⁶ Proizvodi ovih radionica rasprostranjeni su na širem sjeverno-italjskom području, u Magdalensbergu, Kartagi, Rimu, Efezu i Grčkoj.⁵⁷ Pečati *M. Herenija Picensa* pronađeni su u predaugustovskim slojevima Byrse u Kartagi i Codroipa, što ih, uz konzulske datume vlasnika radionica, datira u 1. st. pr. Kr.⁵⁸ Pečati *M. Herenija Phaedima* zastupljeni su duž sjeverne Italije, u Magdalensbergu i Pompejima te su datirani u Augustovu i Tiberijevu vladavinu.⁵⁹ Pečati *M. Herenija Picensa* time pripadaju u razdoblje prije nego što je Tilurij početkom 1. st. po. Kr. postao logor VII. legije. Jedini do sada objavljeni primjerak s područja rimske provincije Dalmacije pronađen je tijekom istraživanja kampusa u Burnu.⁶⁰

first place among the auxiliary units in terms of the number of finds in the province of Dalmatia. However, given the duration of this cohort's stay in the province of Dalmatia, this number is not high. In the case of this cohort, the stamps may primarily be dated on the basis of this cohort's presumed deployment in the province of Dalmatia. It is presumed that this cohort's permanent fort during the 1st century was in Andetrium, and then from the end of the 1st or mid-2nd century it was in Tilurium where it remained until the mid-3rd century.⁵⁰ Besides this stamp, the cohort was also confirmed in Tilurium on the basis of five votive monuments, one building inscription and three gravestones.⁵¹ The narrower dating of the stamp is based on the form of the abbreviation for the word *cohors*. The stamp of *Cohors VIII voluntariorum civium Romanorum* from Tilurium has a simple rectangular shape and on the basis of the abbreviation *c(oh)hor(tis)* it may be dated to the 2nd-3rd century.⁵² All three of the aforementioned stamps from the Franciscan Monastery Archaeological Collection in Sinj bear the abbreviation *coh(ortis)* and on that basis they can be dated to the 1st-3rd century.⁵³ These differences in relation to the stamp from Tilurium point to the conclusion that the two stamps from an unknown find site were probably originally from Aequum rather than Tilurium. Thus far there are no data on manufactures.

One more stamp is held in the Cetina Territorial Museum, which was purchased for the Museum from Petar Tadinac from Gardun (tab. 1. 13; Pl. 1. 13). The inscription *Coh(ortis) [---]* does not offer any basis for a more precise interpretation and dating of the stamp. Based on the known stamps from Tilurium, a stamp of *cohors III Alpinorum* or *VIII voluntariorum civium Romanorum* from the 2nd-3rd century may be considered. But the shape of the truly quite damaged stamp cannot be compared to the shape of the stamps of *cohors III Alpinorum*, and by the same token the abbreviation for *cohors* cannot be tied to that on the stamp of *cohors VIII voluntariorum civium Romanorum*.

STAMPS AND INSCRIPTIONS ON AMPHORAE (TAB. 2; PL. 2-3)

In previous excavations conducted at the Roman legionary fortress of Tilurium, 28 different types of amphorae have been documented. The highest number of examples consists of wine amphorae (*Lamboglia 2*, *Dressel 6A*, *Pascual 1/Dressel*

54 U istraživanje su uključeni ulomci amfora dokumentirani tijekom sustavnih arheoloških istraživanja od 1997. do 2018. godine (Šimić-Kanaet 2003a, Šimić-Kanaet 2010, Šimić-Kanaet 2017, Šimić-Kanaet 2021), kao i oni koji se nalaze u privatnoj zbirci obitelji Roguljić na Gardunu (Bekić 1998) i u Muzeju Cetinske krajine - Sinj (Čerina 2011). Vidi i Vukov 2020.

55 Maier-Maidl 1992, str. 84; Cipriano 2016, str. 149.

56 Cipriano 2016, str. 150; Cipriano, Mazzocchin 2019, str. 236.

57 Maier-Maidl 1992, str. 84-87; Bezeczeky 2013, str. 86; Cipriano 2016, str. 150, bilj. 38.

58 Bezeczeky 1998, str. 230; Cipriano 2016, str. 149.

59 Cipriano 2016, str. 150.

60 Borzić 2020, str. 126-127, tab. 12.

50 Alföldy 1987, pp. 254-255; Zaninović 1996, p. 289; Spaul 2000, pp. 35-37; Matijević 2009, p. 46; Matijević 2013, p. 119.

51 Vrbanc 2012, pp. 34-46, 131-133, cat. no. 22-30; Vukov 2018, pp. 970-971.

52 Vrbanc 2012, pp. 107 and 122, cat. no. 44.

53 Cf. Tončinić *et al.* 2011, pp. 367-368, cat. no. 12-14; Vrbanc 2012, pp. 106-110, 65, 80-82, cat. no. 44, 64-66.

Djelomično sačuvani pečat [---]AIVI (tab. 2. 4; T. 2. 4) mogao bi se pripisati radionici *L(ucius) Salvi(us)* koja je utiskivala pečate na amforama *Lamboglia 2* i *Dressel 6A*. Gens *Salvia* zastupljen je duž italskih regija, od Apulije do Cisalpine, kao i u *Urbs Salvia*, na području čijeg su agera bile organizirane poljoprivredne i proizvodne djelatnosti ove radionice, najvjerojatnije u više proizvodnih središta.⁶¹ Najveća koncentracija pečata pronađena je na sjevernojadranskom području, s nalazima i na području Picenuma, Taranta i Pise. Izvan Italije pronađeni su u Magdalensbergu, Dimalau, Foskom zaljevu, Narboni, Ateni, lasosu, kao i u Naroni u Dalmaciji.⁶²

Među malobrojnim primjercima pečata na amforama iz Tiliurija zastupljena su i četiri primjerka utisnuta u reljefu unutar pravokutne kartuše smještene na obodu amfora *Dressel 6B*, od kojih samo jedan pečat možemo sa sigurnošću odrediti. Pečat *PACCI* (tab. 2. 5; T. 2. 5) pojavljuje se na proizvodima obitelji iz gensa *Paccia*, koja je poznata s brojnih epigrafskih spomenika iz središnje Italije.⁶³ Riječ je o radionici koja se dovodi u vezu s pečatima radionice *VARI PACCI*, koja je djelovala u rano Augustovo doba na području Trevisa.⁶⁴ Za razliku od potonjeg koji je zabilježen u devet različitih inačica, pečat radionice *PACCI* pojavljuje se u jednoj inačici, sastavljenoj od pet slova, bez ligatura.⁶⁵ Smatralo se kako je riječ o još jednoj inačici pečata radionice *VARI PACCI*, no najvjerojatnije je ipak riječ o samostalnoj radionici koja je djelovala u Tiberijevo i Klaudijevo doba, vjerojatno uz kontinuitet istih proizvodnih radionica.⁶⁶ Pečati radionice *PACCI* rasprostranjeni su u većoj koncentraciji na području Padske nizine (Veneto, Padova), a zabilježeni su i u Magdalensbergu, Sirmiju, Emoni, Tharrosu, Sardiniji i Kartagi.⁶⁷ Na istočnoj obali Jadrana zastupljeni su u inačici *VARI PACCI* primjercima iz Pule i Narone.⁶⁸ Na obodu amfore *Dressel 6B* utisnut je i djelomično očuvani pečat *SCAPLIAN[---]* (tab. 2. 6; T. 2. 6). Pečat bi se mogao dovesti u vezu s pečatima radionice *P.Q.SCAPVLAE* koja je utiskivala pečate na amforama *Dressel 6A* i *Dressel 6B*. Pečati ove radionice javljaju se u tri inačice, gdje prve dvije sadrže inicijale prenomena i nomena, dok treća sadrži samo kognomen *SCAPVL[---]*.⁶⁹ Radionica se povezuje s bogatim suvremenikom Cezara i Cicerona pod imenom *P(ublius) Q(uinctius) Scapula*⁷⁰, ali kontekst nalaza pečata navodi

1, *Dressel 2-4*, *Camulodunum 184*, flat-bottomed amphorae, Knidian amphorae) and olive oil amphorae (*Dressel 6B*, *Dressel 20*, various African types), while amphorae for transporting fish products (*Dressel 7-11*) and fruit (*Camulodunum 189*, *Schörgendorfer 558*) are present in lower numbers.⁵⁴ The stamp is impressed on 12 fragments (tab. 2).

Three stamps may be attributed to the workshops of the Picenum manufacturing zone that were owned by members of gens *Herennia*. The letters of the stamps are impressed in relief inside the cartouche situated on the rims of *Dressel 6A* amphorae. The restoration, *M(arci) He[r(enni)] Picenti(s)* (tab. 2. 1; Pl. 2. 1) and *[M(arci) Her(enni) P]icenti(s)* (tab. 2. 2; Pl. 2. 2), mention the consul *Marcus Herennius Picens* as the workshop's owner. The stamp *MHER[---]* (tab. 2. 3; Pl. 2. 3) may have belonged to *Herennius Picens* or *Herennius Phaedimus*. Several members who stamped wine amphorae at the end of the 1st century BC and beginning of the 1st century AD may be ascribed to gens *Herennia*: *M. Herennius Picens*, consul in 34 BC, his eponymous son, also consul in 1 AD, and *M. Herennius Phaedimus* and *Herennius Priscus*, who may most likely be identified as the family's freedmen.⁵⁵ Given that thus far no kilns nor remains of workshop facilities have been found, based on an onomastic analysis and the distribution of the stamps, it has been assumed that the workshop was situated somewhere in the Picenum region, which was also recently confirmed by archaeometric analysis.⁵⁶ The products of this workshop were widespread throughout northern Italy, and in Magdalensberg, Carthage, Rome, Ephesus and Greece.⁵⁷ Stamps of *M. Herennius Picens* have been found in the pre-Augustan layers at Byrsa in Carthage and Codroipo, which, with the consul dates of the workshop owner, dates them to the 1st century BC.⁵⁸ Stamps of *M. Herennius Phaedimus* are present throughout northern Italy, in Magdalensberg and Pompeii and have been dated to the reigns of Augustus and Tiberius.⁵⁹ Stamps of *M. Herennius Picens* thus belong to the period prior to the point that Tiliurium became the fortress of Legio VII at the beginning of the 1st century AD. The only thus far published example from the territory of the Roman province of Dalmatia was found during excavations at the campus in Burnum.⁶⁰

61 Menchelli, Ciuccarelli 2009, str. 4; Mongardi 2018, str. 91.

62 Patch 1907, str. 117, sl. 66; Maier-Maidl 1992, str. 100; Mongardi 2018, str. 91.

63 Cipriano, Mazzocchin 2000, str. 151.

64 Maier-Maidl 1992, str. 68-71; Bezeczký 1994, str. 80; Cipriano, Mazzocchin 2000, str. 152-157; Cipriano, Mazzocchin 2019, str. 239.

65 Cipriano, Mazzocchin 2000, str. 159-160, sl. 4.

66 Cipriano, Mazzocchin 2000, str. 152.

67 Bezeczký 1994, str. 80, 85-87, br. 119-121; Mazzocchin 2011, str. 200; Mongardi 2018, str. 107.

68 Patch 1907, str. 117, sl. 66; Starac 2001, str. 270.

69 Cipriano, Mazzocchin 2000, str. 169-175.

70 Maier-Maidl 1992, str. 63; Cipriano, Mazzocchin 2000, str. 173-174.

54 The research encompassed amphora fragments documented during systematic archaeological excavations conducted from 1997 to 2018 (Šimić-Kanaet 2003a, Šimić-Kanaet 2010, Šimić-Kanaet 2017, Šimić-Kanaet 2021), as well as those found in the private collection of the Roguljić family in Gardun (Bekić 1998) and the Cetina Territorial Museum in Sinj (Čerina 2011). See also Vukov 2020.

55 Maier-Maidl 1992, p. 84; Cipriano 2016, p. 149.

56 Cipriano 2016, p. 150; Cipriano, Mazzocchin 2019, p. 236.

57 Maier-Maidl 1992, pp. 84-87; Bezeczký 2013, p. 86; Cipriano 2016, p. 150, note 38.

58 Bezeczký 1998, p. 230; Cipriano 2016, p. 149.

59 Cipriano 2016, p. 150.

60 Borzić 2020, pp. 126-127, tab. 12.

na kasniju dataciju, u zadnja desetljeća 1. st. pr. Kr. pa sve do sredine 1. st. po. Kr.⁷¹ Ubikacija radionice pretpostavlja se na području Verone⁷², s distribucijom duž sjeverne Italije i u Magdalensbergu.⁷³ Paralele pečatu iz Tilurija nalazimo i u Novom Sadu, gdje su pronađena tri slična pečata pročitana *SCALPIANM* ili *SCALPIANIM*.⁷⁴ Djelomično očuvani pečati *MIE[---]* i *[---]SCE* nemaju pouzdane analogije (tab. 2. 7-8; T. 2. 7-8).

Ulomak vrata amfore sadrži pečat utisnut u dva retka s natpisom *IVLI / MARCEL* (tab. 2. 9; T. 2. 9). Ovaj tip pečata za sada je zastupljen isključivo na amforama s ljevkastim vratom i amforama ravnog dna, a pripisuje se radionici *C. IVLI MARCELLI*. Pečati ove radionice pronađeni su na području regije Veneto u sjevernoj Italiji te u Ateni i Korintu.⁷⁵ Pretpostavlja se da je radionica djelovala na području srednjeg Jadrana tijekom 1. st. po. Kr.⁷⁶ Za natpis *[Fa]vor C(ai) L(ibertus) Mode[stus ili stinus?]* koji je otisnut na drški okruglog presjeka (tab. 2. 10; T. 2. 10) za sada ne nalazimo analogije.⁷⁷ Djelomično očuvani pečat *ART[---]* (tab. 2. 11; T. 2. 11) izveden je na rubu amfore *Lamboglia 2* (?), kojem analogije nalazimo u Puli.⁷⁸ Jedan pečat zbog oštećenja nije odrediv (tab. 2. 12; T. 2. 12).

Osim na amforama natpise nalazimo i na njihovim poklopcima. Osam poklopaca amfora iz Tilurija sadrži nečitak natpis izveden reljefnim slovima (T. 2. 13-16, T. 3. 17-21).⁷⁹

Pečatima se obilježavalo ime upravitelja ili vlasnika keramičarske radionice, dok informacije o težini amfore, imenu trgovca, podrijetlu i količini proizvoda u amfori saznajemo preko grafitu.⁸⁰ Grafiti su izvedeni na pet ulomaka amfora iz Tilurija (T. 3. 22-26)⁸¹, među kojima izdvajamo grafit na kasnoantičkoj amfori istočnomediteranskog podrijetla *Agora M273* (T. 3. 26), koje se datiraju u 4. – 6. st. Na ramenu amfore urezan je grafit λ Δ, gdje grčka slova lambda i delta označavaju zapreminu

A partially preserved stamp *[---]AIVI* (tab. 2. 4; Pl. 2. 4) may be attributed to the *L(ucius) Salvi(us)* workshop which impressed the stamps on *Lamboglia 2* and *Dressel 6A* amphorae. *Gens Salvia* was present throughout the Italic regions, from Apulia to the Cisalpine zone, and in *Urbs Salvia*, in which ager this workshop's agricultural and manufacturing activities were organised, probably in several production centres.⁶¹ The highest concentration of stamps was found in the northern Adriatic region, but with finds in the territory of Picenum, Tarentum and Pisa. Outside of Italy, they have been found in Magdalensberg, Dimale, La Fosca Bay, Narbonne, Athens, Iasos, and in Naronia in Dalmatia.⁶²

The numerous stamps on amphorae from Tilurium include four examples that are impressed in relief inside a rectangular cartouche situated on the rims of *Dressel 6B* amphorae, of which only one may be discerned with any certainty. The stamp *PACCI* (tab. 2. 5; Pl. 2. 5) appeared on the products of the family of *gens Paccia*, which is known on numerous epigraphic monuments from central Italy.⁶³ This was a workshop that has been linked to the stamps from the *VARI PACCI* workshop, which operated in the Treviso area in the early Augustan era.⁶⁴ As opposed to the latter, which has been recorded in nine distinct variants, the stamp of the *PACCI* workshop only appeared in a single variant, consisting of five letters without ligatures.⁶⁵ It was believed that this was just one variant of the stamps of the *VARI PACCI* workshop, but it was in fact most likely an independent workshop that operated in the Tiberian and Claudian eras, probably in continuity of the same manufacturing workshops.⁶⁶ The stamps of the *PACCI* workshop were widespread in a higher concentration in the Po Valley (Veneto, Padua), and they were also recorded in Magdalensberg, Syrmia, Emona, Tharros, Sardinia and Carthage.⁶⁷ In the eastern Adriatic seaboard, examples in the *VARI PACCI* variant came from Pula and Naronia.⁶⁸ A partially preserved stamp reading *SCAPLIAN[---]* (tab. 2. 6; Pl. 2. 6) was also impressed on the rim of a *Dressel 6B* amphora. The stamp may be linked to the stamps of the *P.Q.SCAPVLAE* workshop which impressed stamps on *Dressel 6A* and *Dressel 6B* amphorae. The stamps of this workshop appear in three variants, where the first contains the initials of the praenomen and nomen, while the

71 Cipriano, Mazzocchin 2000, str. 173-174.

72 Cipriano, Mazzocchin 2000, str. 175.

73 Maier-Maidl 1992, str. 63; Cipriano, Mazzocchin 2000, str. 171-172, sl. 9.

74 Mongardi 2018, str. 122, br. 168.

75 Mazzocchin 2009, str. 201, tab. 2, 15-22.

76 Mazzocchin 2009, str. 202.

77 Bulić 1908, str. 127, br. 1.

78 Starac 2008, br. 14-15.

79 T. 2. 13: Šimić-Kanaet 2010, str. 357, kat. br. 3126; T. 2. 14: Šimić-Kanaet 2010, str. 357, kat. br. 3127; T. 2. 15: Šimić-Kanaet 2010, str. 358, kat. br. 3130; T. 2. 16: Šimić-Kanaet 2010, str. 358, kat. br. 3131; T. 3. 17: Šimić-Kanaet 2017, str. 125, kat. br. 225; T. 3. 18: Šimić-Kanaet 2017, str. 125, kat. br. 226; T. 3. 19: Šimić-Kanaet 2017, str. 125, kat. br. 227; T. 3. 20: Šimić-Kanaet 2017, str. 125, kat. br. 229; T. 3. 21: Šimić-Kanaet 2017, str. 125, kat. br. 230.

80 Ožanić 2005, str. 138.

81 T. 3. 22: Šimić-Kanaet 2003, str. 159, kat. br. 138; T. 3. 23: Šimić-Kanaet 2010, str. 343, kat. br. 2947; T. 3. 24: Šimić-Kanaet 2010, str. 346, kat. br. 2986; T. 3. 25: Šimić-Kanaet 2010, str. 339, kat. br. 2896; T. 3. 26: Čerina 2011, str. 220-221, kat. br. 3.

61 Menchelli, Ciuccarelli 2009, p. 4; Mongardi 2018, p. 91.

62 Patch 1907, p. 117, fig. 66; Maier-Maidl 1992, p. 100; Mongardi 2018, p. 91.

63 Cipriano, Mazzocchin 2000, p. 151.

64 Maier-Maidl 1992, pp. 68-71; Bezeczký 1994, p. 80; Cipriano, Mazzocchin 2000, pp. 152-157; Cipriano, Mazzocchin 2019, p. 239.

65 Cipriano, Mazzocchin 2000, pp. 159-160, fig. 4.

66 Cipriano, Mazzocchin 2000, p. 152.

67 Bezeczký 1994, p. 80, 85-87, no. 119-121; Mazzocchin 2011, p. 200; Mongardi 2018, p. 107.

68 Patch 1907, p. 117, fig. 66; Starac 2001, p. 270.

	Signatura	Oblik posude	Pečat	Datacija	Literatura
1	zbirka S. Roguljić	Dressel 6A	MHE[---] PICENTI	kraj 1. st. pr. Kr. - poč. 1. st. po. Kr.	Bekić 1998, str. 234, kat. br. 16-23, T. 2.10.
2	zbirka S. Roguljić	Dressel 6A	[---]ICENTI	kraj 1. st. pr. Kr. - poč. 1. st. po. Kr.	Bekić 1998, str. 234, kat. br. 16-23, T. 2.11.
3	GAR 03 PN 54	Dressel 6A	MHER [---]	poč. 1. st. po. Kr.	Šimić-Kanaet 2010, str. 331, kat. br. 2810.
4	GAR 05 9295	Dressel 6A / Lamboglia 2	[---] AIVI [---]	poč. 1. st. po. Kr.	Šimić-Kanaet 2010, str. 332, kat. br. 2813.
5	GAR 05 PN 157	Dressel 6B	PACCI	sredina 1. st. po. Kr.	Šimić-Kanaet 2010, str. 331, kat. br. 2812.
6	GAR 07 PN 27	Dressel 6 A/B	SCAPLIAN[---]	prva pol. 1. st. po. Kr.	Šimić-Kanaet 2017, str. 123, kat. br. 213.
7	GAR 04 PN 46	Dressel 6B	M I E [---]	1. st. po. Kr.	Šimić-Kanaet 2010, str. 331, kat. br. 2811.
8	GAR 08 PN 103	Dressel 6B	[---]SCE	1. st. po. Kr.	Šimić-Kanaet 2017, str. 123, kat. br. 211.
9	AMS-Fb-519		IVLI / MARCEL	1. st. po. Kr.	CIL III 14035; Bulić 1895, str. 38.
10	AMS-Fb-610		[---]VOR C L MODE[---]		Bulić 1908, str. 127, br. 1.
11	GAR 02 PN 14		ART [---]	50. god. pr. Kr.- poč. 1. st. po. Kr.	Šimić-Kanaet 2010, str. 339, kat. br. 2899.
12	GAR 03 846		?		Šimić-Kanaet 2010, str. 345, kat. br. 2966.

	Signature	Vessel form	Stamp	Dating	Literature
1	S. Roguljić collection	Dressel 6A	MHE[---] PICENTI	end of 1st c. BC - beginning of 1st c. AD	Bekić 1998, p. 234, cat. no. 16-23, Pl. 2.10.
2	S. Roguljić collection	Dressel 6A	[---]ICENTI	end of 1st c. BC - beginning of 1st c. AD	Bekić 1998, p. 234, cat. no. 16-23, Pl. 2.11.
3	GAR 03 PN 54	Dressel 6A	MHER [---]	beginning of 1st c. AD	Šimić-Kanaet 2010, p. 331, cat. no. 2810.
4	GAR 05 9295	Dressel 6A / Lamboglia 2	[---] AIVI [---]	beginning of 1st c. AD	Šimić-Kanaet 2010, p. 332, cat. no. 2813.
5	GAR 05 PN 157	Dressel 6B	PACCI	mid-1st c. AD	Šimić-Kanaet 2010, p. 331, cat. no. 2812.
6	GAR 07 PN 27	Dressel 6 A/B	SCAPLIAN[---]	first half of 1st c. AD	Šimić-Kanaet 2017, p. 123, cat. no. 213.
7	GAR 04 PN 46	Dressel 6B	M I E [---]	1st c. AD	Šimić-Kanaet 2010, p. 331, cat. no. 2811.
8	GAR 08 PN 103	Dressel 6B	[---]SCE	1st c. AD	Šimić-Kanaet 2017, p. 123, cat. no. 211.
9	AMS-Fb-519		IVLI / MARCEL	1st c. AD	CIL III 14035; Bulić 1895, p. 38.
10	AMS-Fb-610		[---]VOR C L MODE[---]		Bulić 1908, p. 127, no. 1.
11	GAR 02 PN 14		ART [---]	50 BC - beginning of 1st c. AD	Šimić-Kanaet 2010, p. 339, cat. no. 2899.
12	GAR 03 846		?		Šimić-Kanaet 2010, p. 345, cat. no. 2966.

Tablica 2.
Pečati na amforama iz Tilurija

Table 2.
Stamps on amphorae from Tilurium

amfore 34, najvjerojatnije sekstarija (18,598 litara).⁸² Grafit na amfori *Agora M273*, spada među nalaze koji jasno potvrđuju nastavak života i gospodarskih kretanja u Tiluriju i nakon odlaska posljednje vojne jedinice, iako Tilurij nikada nije prerastao u veće antičko naselje.

third contains only the cognomen *SCAPVL[---]*.⁶⁹ The workshop is associated with the wealthy contemporary of Caesar and Cicero named *P(ublius) Q(uinctius) Scapula*,⁷⁰ but the discovery context of the stamp points to a later date, in the final decade of the first century BC all the way to the mid-1st century AD.⁷¹ The precise location of the workshop is assumed to have been in the Verona area,⁷² with distribution throughout northern Italy and in Magdalensberg.⁷³ Parallels to the stamp from Tilurium can also be found in Novi Sad, where three similar stamps reading *SCALPIANM* or *SCALPIANIM* were found.⁷⁴ The partially preserved stamps *MIE[---]* and *[---]SCE* have no certain analogies (tab. 2. 7-8; Pl. 2. 7-8).

A fragment of an amphora neck bears a stamp impressed in two lines with the inscription *IVLI/MARCEL* (tab. 2. 9; Pl. 2. 9). This type of stamp has thus far only been seen on amphorae with funnel-shaped necks and flat-bottomed amphorae, and they have been attributed to the *C. IVLI MARCELLI* workshop. The stamps of this workshop have been found in the Veneto region in northern Italy and in Athens and Corinth.⁷⁵ It is assumed that the workshop operated in the area of the central Adriatic during the 1st century AD.⁷⁶ Thus far, no analogies have been found for the inscription *[F]avor C(ai) L(ibertus) Mode[stus] ili stinus?* that is impressed on a handle with circular cross-section (tab. 2. 10; Pl. 2. 10).⁷⁷ A partially preserved stamp *ART[---]* (tab. 2. 11; Pl. 2. 11) is rendered on the edge of a *Lamboolia 2 (?)* amphora, for which there are analogies in Pula.⁷⁸ One stamp cannot be ascertained due to damage (tab. 2. 12; Pl. 2. 12).

Besides amphorae, inscriptions can also be found on their lids. Eight amphora lids from Tilurium bear illegible inscriptions rendered in relief letters (Pl. 2. 13-16, Pl. 3. 17-21).⁷⁹

Stamps were used to denote the name of the manager or owner of ceramic workshops, while information on the weight of amphorae, the merchant's name, the origin and quantity of the product in the amphorae were provided by graffiti.⁸⁰ Graf-

69 Cipriano, Mazzocchin 2000, pp. 169-175.

70 Maier-Maidl 1992, p. 63; Cipriano, Mazzocchin 2000, pp. 173-174.

71 Cipriano, Mazzocchin 2000, pp. 173-174.

72 Cipriano, Mazzocchin 2000, p. 175.

73 Maier-Maidl 1992, p. 63; Cipriano, Mazzocchin 2000, pp. 171-172, fig. 9.

74 Mongardi 2018, p. 122, no. 168.

75 Mazzocchin 2009, p. 201, tab. 2, 15-22.

76 Mazzocchin 2009, p. 202.

77 Bulić 1908, p. 127, no. 1.

78 Starac 2008, no. 14-15.

79 Pl. 2. 13: Šimić-Kanaet 2010, p. 357, cat. no. 3126; Pl. 2. 14: Šimić-Kanaet 2010, p. 357, cat. no. 3127; Pl. 2. 15: Šimić-Kanaet 2010, p. 358, cat. no. 3130; Pl. 2. 16: Šimić-Kanaet 2010, p. 358, cat. no. 3131; Pl. 3. 17: Šimić-Kanaet 2017, p. 125, cat. no. 225; Pl. 3. 18: Šimić-Kanaet 2017, p. 125, cat. no. 226; Pl. 3. 19: Šimić-Kanaet 2017, p. 125, cat. no. 227; Pl. 3. 20: Šimić-Kanaet 2017, p. 125, cat. no. 229; Pl. 3. 21: Šimić-Kanaet 2017, p. 125, cat. no. 230.

80 Ožanić 2005, p. 138.

82 Čerina 2011, str. 220-221, kat. br. 3.

PEČATI I NATPISI NA SIGILATNIM PROIZVODIMA (TAB. 3; T. 4-6)

Pečati otisnuti na posudama *terra sigillata* pružaju uvid u strukturu proizvodnje i distribucije te keramike, kao i vrijedne informacije o trgovačkim odnosima različitih provincija Rimskog Carstva. U Tiluriju su dokumentirani različiti oblici sigilatnih posuda koji potječu iz italskih, istočnih i afričkih keramičkih proizvodnih središta koji se vremenski datiraju od 1. st. pr. Kr. do kasne antike.⁸³ Brojnošću prevladavaju ulomci italske proizvodnje, datirani u 1. st. po. Kr.⁸⁴ Dokumentirano je 38 pečata, od toga 33 na glatkoj i 5 na reljefnoj sigilati. Među pečatima na glatkoj sigilati čitljivo je njih 17, koji sadrže imena italskih radionica, jedan s imenom galske radionice i dva neidentificiranih radionica; preostalih 13 pečata nije čitljivo (tab. 3). Graffiti su zabilježeni na sedam posuda (T. 4. 11, 14, T. 5. 34, T. 6. 35-38).⁸⁵ Riječ je o nečitkim grafitima koji se ovdje sabiru i objavljuju. Za eventualno čitanje potrebno je provesti daljnje analize, koje prelaze okvire ovog članka.

Od pečata italskog podrijetla 12 ih potječe iz sjeverne Italije (*Calamvs, Fvscvs, Melito, Nico, Sarius, Solo, Severvs, Vegetvs, Fortvnatvs*), tri s područja Arezza (*Camvrivs* ili *C.Mvrivs, P. Clodivs Proclvs, L. Gelli*), jedan iz srednje Italije (*M. Gratidivs*), dok jednom nije moguće preciznije odrediti radioničko središte (*C. Crestivs*).⁸⁶ Unutar četvrtastog polja utisnuto je osam pečata, dok je devet pečata utisnuto u formi *in planta pedis*. Ta se forma pečata javlja nakon 15. god. po. Kr.⁸⁷

Na području sjeverne Italije djelovao je velik broj manjih radionica, među kojima je i devet radionica dokumentiranih na dvanaest pečata iz Tilurija, datiranih od 15. god. pr. Kr. do 40. god. po. Kr. Najranije su datirani pečati radionice *Severvs*, zastupljeni s dva primjerka na posudama oblika *Consp. 18* (tab. 3. 17; T. 5. 17) i *Consp. 7.1.3.* (tab. 3. 18; T. 5. 18). Ovaj lončar djelovao je u razdoblju od oko 15. god. pr. Kr. do 1. god. po. Kr.,⁸⁸ a na istočnoj obali Jadrana dokumentiran je još i u Burnu i Osoru.⁸⁹ Pečat lončara Nikolausa (*Nicolaus*) utisnut je unutar pravokutnog polja na dnu dvije posude (tab. 3. 11-12; T. 4. 11-12), od kojih je jedna forme *Consp. 24.3.1.* Riječ je o lončaru koji je djelovao u razdoblju od oko 15. god. pr. Kr. do 40. god. po.

fiti were inscribed on five amphorae fragments from Tilurium (Pl. 3. 22-26),⁸¹ among which we may distinguish the graffito on the eastern Mediterranean *Agora* M273 (Pl. 3. 26) amphora from Late Antiquity, which has been dated to the 4th-6th centuries. The graffito λ Δ was incised onto the shoulder of the amphora, where the Greek letters lambda and delta indicate the volume of the amphora, 34, most likely sextaria (18.598 litres).⁸² The graffito on the *Agora* M273 amphora belongs among the finds that clearly confirm the continuity of life and economic flows in Tilurium even after the departure of the last military unit, even though Tilurium never grew into a large Roman-era settlement.

STAMPS AND INSCRIPTIONS ON *TERRA SIGILLATA* PRODUCTS (TAB. 3; PL. 4-6)

Stamps impressed on *terra sigillata* vessels offer insight into the structure of the production and distribution of these ceramics, as well as valuable information on mercantile relations between different provinces of the Roman Empire. Various forms of *terra sigillata* vessels originally from Italic, Oriental and African ceramic production hubs dated from the 1st century BC to Late Antiquity have been documented in Tilurium.⁸³ Fragments produced in Italy, dated to the 1st century AD, predominate.⁸⁴ 38 stamps have been documented, of them 33 on plain and 5 on relief *sigillata*. Among the stamps on plain *sigillata*, 17 are legible, containing either the names of Italic workshops, one Gallic workshop and two unidentified workshops; the remaining 13 stamps are illegible (tab. 3). Graffiti have been recorded on seven vessels (Pl. 4. 11, 14, Pl. 5. 34, Pl. 6. 35-38).⁸⁵ These are illegible graffiti that are herein consolidated and published. Further analysis, beyond the framework of this paper, will be required for a possible reading.

Among the stamps of Italic origin, 12 are from northern Italy (*Calamvs, Fvscvs, Melito, Nico, Sarius, Solo, Severvs, Vegetvs, Fortvnatvs*), three are from the Arezzo area (*Camvrivs* or *C.Mvrivs, P. Clodivs Proclvs, L. Gelli*), one is from central Italy (*M. Gratidivs*), while the workshop centre cannot be more precisely determined for one (*C. Crestivs*).⁸⁶ Eight stamps are

83 Šimić-Kanaet 2003a, 2010, 2017, 2021.

84 Šimić-Kanaet 2017, str. 78.

85 Bekić 1998, kat. br. 7; Šimić-Kanaet, Zaninović 2007, str. 238, 239; Šimić-Kanaet 2010, kat. br. 9, 20, 21; Šimić-Kanaet 2021, kat. br. 35.

86 Pečati su određeni prema A. Oxe, H. Comfort, P. Kenrick, *Corpus Vasorum Arretinorum, A Catalogue of the Signatures, Shapes and Chronology of Italian Sigillata, II. edition*, Bonn 2000 (dalje u tekstu OCK).

87 OCK, str. 9.

88 OCK, str. 407, tip 1956 (1820).

89 Makjanić 1985, str. 43; Borzić 2013, str. 143; Borzić 2020, str. 44, tab. 1.

81 Pl. 3. 22: Šimić-Kanaet 2003, p. 159, cat. no. 138; Pl. 3. 23: Šimić-Kanaet 2010, p. 343, cat. no. 2947; Pl. 3. 24: Šimić-Kanaet 2010, p. 346, cat. no. 2986; Pl. 3. 25: Šimić-Kanaet 2010, p. 339, cat. no. 2896; Pl. 3. 26: Čerina 2011, pp. 220–221, cat. no. 3.

82 Čerina 2011, pp. 220–221, cat. no. 3.

83 Šimić-Kanaet 2003a, 2010, 2017, 2021.

84 Šimić-Kanaet 2017, p. 78.

85 Bekić 1998, kat. no. 7; Šimić-Kanaet, Zaninović 2007, pp. 238, 239; Šimić-Kanaet 2010, kat. no. 9, 20, 21; Šimić-Kanaet 2021, kat. no. 35.

86 The stamps have been classified according to A. Oxe, H. Comfort, P. Kenrick, *Corpus Vasorum Arretinorum, A Catalogue of the Signatures, Shapes and Chronology of Italian Sigillata, II. edition*, Bonn 2000

Kr.⁹⁰, a čiji su pečati zastupljeni u Burnu, Saloni i Zadru.⁹¹ Na dvije posude smješten je i pečat lončara Sarius (Sarius) (tab. 3. 14-15; T. 4. 14-15), čiji se proizvodi datiraju od 10. god. pr. Kr. do 20. god. po. Kr.⁹², a zastupljeni su još i u Burnu i Saloni.⁹³ Na četiri zdjelice oblika *Consp. 26/27* utisnuti su pečati CALMI (*Calamvs*)⁹⁴ (tab. 3. 3; T. 4. 3), FVSCI (*Fvscvs*)⁹⁵ (tab. 3. 7; T. 4. 7), MELITO (*Melito*)⁹⁶ (tab. 3. 10; T. 4. 10) i VEGET[---] (*Vegetvs*)⁹⁷ (tab. 3. 22; T. 5. 22), datirani u prvu polovicu 1. st. po. Kr. Pojedinačnim primjercima zastupljeni su još sjevernoitalski lončari Solo⁹⁸ (tab. 3. 16; T. 5. 16) i *Fortvnatvs*⁹⁹ (?) (tab. 3. 23; T. 5. 23).

Aretinskim radionicama moguće je pripisati samo tri pečata, utisnuta u formi *in planta pedis*. Među njima je najraniji [---] LLI (tab. 3. 24; T. 5. 24), koji pripada radionici Gelli ili L. Gelli. Djelovanje ove radionice prati se od oko 15. god. pr. Kr. pa sve do 50. god. po. Kr., s rasprostranjenošću proizvoda duž sjeverne Italije i dunavskih provincija.¹⁰⁰ Riječ je o radionici koja je zastupljena velikim brojem pečata na istočnoj obali Jadrana, o čemu svjedoče nalazi iz Nina, Zadra, Osora, Krka, Burna, Salone, okolice Sinja i Narone.¹⁰¹ S obzirom na formu *in planta pedis*, pečate iz Tilurija moguće je datirati nakon 15. god. po. Kr. Pečat CMVRI (tab. 3. 5; T. 4. 5), utisnut na šalici tipa *Consp. 22*, pripada radionici *Camvrivs* ili C. *Mvrivs*, koja je najvjerojatnije djelovala na području Arezza od 30. do 70. god. po. Kr.¹⁰² Treći primjerak pripada lončaru P. Klodiju Prokulu (P. *Clodivs Procvlvs*), čije se djelovanje datira između 40. i 100. god. po. Kr. (tab. 3. 13; T. 4. 13).¹⁰³

impressed inside a rectangular field, while nine are impressed in the *planta pedis* form. This form appeared after 15 AD.⁸⁷

A high number of small workshops operated in northern Italy, among them nine workshops that have been documented on twelve stamps from Tilurium, dated to period from 15 to 40 AD. The earliest dated stamps are from the Severus (*Severvs*) workshop, represented by two examples on *Consp. 18* (tab. 3. 17; Pl. 5. 17) and *Consp. 7.1.3.* (tab. 3. 18; Pl. 5. 18) vessels. This potter operated in the period from roughly 15 BC to 1 AD,⁸⁸ and in the eastern Adriatic his products have been documented at Burnum and Osor as well.⁸⁹ The stamp of the potter *Nicolaus* was impressed inside a rectangular field on the bottom of two vessels (tab. 3. 11-12; Pl. 4. 11-12), of which one is form *Consp. 24.3.1*. This was a potter who was active from roughly 15 BC to 40 AD,⁹⁰ and whose stamps are present in Burnum, Salona and Zadar.⁹¹ Two vessels also bear the stamp of the potter *Sarius* (tab. 3. 14-15; Pl. 4. 14-15), whose products have been dated from 10 BC to 20 AD,⁹² and they are also present in Burnum and Salona.⁹³ Four *Consp. 26/27* small bowls have impressed on them the stamps CALMI (*Calamvs*)⁹⁴ (tab. 3. 3; Pl. 4. 3), FVSCI (*Fvscvs*)⁹⁵ (tab. 3. 7; Pl. 4. 7), MELITO (*Melito*)⁹⁶ (tab. 3. 10; Pl. 4. 10) and VEGET[---] (*Vegetvs*)⁹⁷ (tab. 3. 22; Pl. 5. 22), dated to the first half of the 1st century AD. The northern Italic potters Solo⁹⁸ (tab. 3. 16; Pl. 5. 16) and *Fortvnatvs*⁹⁹ (?) (tab. 3. 23; Pl. 5. 23) are also present on individual examples.

Only three stamps, impressed in *planta pedis* form, may be attributed to the Arretine workshops. Among them the earliest [---]LLI (tab. 3. 24; Pl. 5. 24) was a product of the Gelli or L. Gelli workshop. The activity of this workshop may be followed from roughly 15 BC until 50 AD, with distribution of products throughout northern Italy and the Danubian provinces.¹⁰⁰

90 OCK, str. 300, tip 1267.

91 Burn: Borzić 2013, str. 140-141; Borzić 2020, str. 42, tab. 1; Salona: Von Gonzenbach 1975, str. 200, T. 71, 72; Zadar: Martinov 2017, str. 36, kat. br. 38.

92 OCK, str. 378, tip 1782 (1655).

93 Šimić-Kanaet 2003b, str. 456; Borzić 2013, str. 146, tab. 1, br. 32-33; Borzić 2020, str. 43, tab. 1.

94 OCK, str. 168, tip 485 (360).

95 OCK, str. 229, tip 857 (719).6. Analogije nalazimo u Zadru (Prtenjača 2011, str. 59).

96 OCK, str. 278, tip 1135 (983). Analogije nalazimo u Burnu (Borzić 2020, str. 42, tab. 1), Osoru (Makjanić 1985, str. 43) i Zadru (Prtenjača 2011, str. 66, kat. br. 9).

97 OCK, str. 468, tip 2335 (2249). Analogije nalazimo u Burnu (Borzić 2013, str. 147, tab. 1, br. 51; Borzić 2020, str. 45, tab. 1).

98 OCK, str. 409, tip 1977 (1841).6. Analogije nalazimo u Burnu (Borzić 2020, str. 44, tab. 1).

99 OCK, str. 228, tip 846.6.

100 OCK, str. 46, 233-237, tip 878 ili 879.

101 Nin: Borzić *et al.* 2013, str. 41, kat. br. B1; Zadar: Prtenjača 2011, str. 64, kat. br. 1; Osor: Makjanić 1985, str. 43; Krk-Šinigoj: Konestra 2015, str. 589, br. 11-17; Burn: Borzić 2013, str. 145, tab. 1, br. 14-17; Borzić 2020, str. 37, tab. 1; Salona: Clairmont *et al.* 1975, str. 95, 101, 105; okolica Sinja: Babić 2008, str. 192, kat. br. 18, 19; Narona: Topić 2003, str. 190.

102 OCK, str. 173, tip 514 (397) ili OCK, str. 287, tip 1200.4. Analogije nalazimo u Naroni (Topić 2003, str. 190).

103 OCK, str. 186, tip 592 (454).14.

(hereinafter OCK).

87 OCK, p. 9.

88 OCK, p. 407, type 1956 (1820).

89 Makjanić 1985, p. 43; Borzić 2013, p. 143; Borzić 2020, p. 44, tab. 1.

90 OCK, p. 300, type 1267.

91 Burnum: Borzić 2013, pp. 140-141; Borzić 2020, p. 42, tab. 1; Salona: Von Gonzenbach 1975, p. 200, Pl. 71, 72; Zadar: Martinov 2017, p. 36, cat. no. 38.

92 OCK, p. 378, type 1782 (1655).

93 Šimić-Kanaet 2003b, p. 456; Borzić 2013, p. 146, tab. 1, no. 32-33; Borzić 2020, p. 43, tab. 1.

94 OCK, p. 168, type 485 (360).

95 OCK, p. 229, type 857 (719).6. Analogies can be found in Zadar (Prtenjača 2011, p. 59).

96 OCK, p. 278, type 1135 (983). Analogies can be found in Burnum (Borzić 2020, p. 42, tab. 1), Osor (Makjanić 1985, p. 43) and Zadar (Prtenjača 2011, p. 66, cat. no. 9).

97 OCK, p. 468, type 2335 (2249). Analogies can be found in Burnum (Borzić 2013, p. 147, tab. 1, no. 51; Borzić 2020, p. 45, tab. 1).

98 OCK, p. 409, type 1977 (1841).6. Analogies can be found in Burnum (Borzić 2020, p. 44, tab. 1).

99 OCK, p. 228, type 846.6.

100 OCK, p. 46, 233-237, type 878 or 879.

	Signatura	Oblik posude	OČK	Oblik pečata	Pečat	Grafit	Podrijetlo	Datacija	Literatura
1	GAR 99 PN 2		?	□	AGM[---]		?		Šimić-Kanaet, Zaninović 2007, str. 242.
2	GAR 99 459		?	ipp	BOCCA		?	nakon 15. god. po. Kr.	Šimić-Kanaet, Zaninović 2007, str. 243.
3	GAR 04 PN 15	Consp. 26/27	485 (360)	ipp	CALMI		Padaska nizina	od 15. god. po. Kr.	Šimić-Kanaet 2010, str. 80, kat. br. 7.
4	GAR 99 PN 5		696 (426)	ipp	C CRES		?	1. god. po. Kr. ?	Šimić-Kanaet, Zaninović 2007, str. 241.
5	GAR 04 PN 119	Consp. 22	514 (397) / 1200.4	ipp	CMVRI		Arezzo	30. - 70. god. po. Kr.	Šimić-Kanaet 2010, str. 80, kat. br. 8.
6	GAR 04 PN 64	Consp. 13	?	□	D[---] / [---]		?	1. st. po. Kr.	Šimić-Kanaet 2010, str. 90, kat. br. 110.
7	GAR 02 PN 11	Consp. 26/27	857 (719).6.	ipp	FVSCI		Padaska nizina	1. - 15. god. po. Kr.	Šimić-Kanaet 2010, str. 81, kat. br. 13.
8	GAR 09 PN 9	Consp. 22	894	□	GRAT		srednja Italija	1. st. po. Kr.	Šimić-Kanaet 2017, str. 100, kat. br. 31.
9	GAR 08 338	Consp. 36 (?)	?		M[---]		?	1. st. po. Kr.	Šimić-Kanaet 2017, str. 102, kat. br. 45.
10	GAR 02 PN 23	Consp. 26/27	1135 (983)	□	MELITO		Padaska nizina	1. - 20. god. po. Kr.	Šimić-Kanaet 2010, str. 80, kat. br. 10.
11	GAR 99 VodPN 67		1267 (1121).3.	□	NICO	M	Padaska nizina	15. god. pr. Kr. - 40. god. po. Kr.	Šimić-Kanaet, Zaninović 2007, str. 238.
12	GAR 02 PN 20	Consp. 24.3.1.	1267 (1121).3.	□	NICO		Padaska nizina	15. god. pr. Kr. - 40. god. po. Kr.	Šimić-Kanaet 2010, str. 80, kat. br. 11.
13	GAR 98 PN 1		592 (454).14.	ipp	P CLO P		Arezzo	40. - 100. god. po. Kr.	Šimić-Kanaet, Zaninović 2007, str. 240.
14	GAR 99 VodPN 65		1782 (1655)	□	SARI	APTI	Padaska nizina	10. god. pr. Kr. - 20. god. po. Kr.	Šimić-Kanaet, Zaninović 2007, str. 239.
15	GAR 09 PN 8		1782 (1655)	□	[---]JARI		Padaska nizina	10. god. pr. Kr. - 20. god. po. Kr.	Šimić-Kanaet 2017, str. 102, kat. br. 44.
16	GAR 02 PN 31		1977 (1841).6	□	SO[---]		Padaska nizina	1. - 40. god. po. Kr.	Šimić-Kanaet 2010, str. 81, kat. br. 18.
17	GAR 15 PN 417	Consp. 18	1956 (1820)	ipp	SEV[---]		Padaska nizina	15. god. pr. Kr. - 1. god. po. Kr.	Šimić-Kanaet 2021, str. 100, kat. br. 6.
18	GAR 02 PN 45	Consp. 7.1.3.	1956 (1820)	□	SEV[---]		Padaska nizina	15. god. pr. Kr. - 1. god. po. Kr.	Šimić-Kanaet 2010, str. 80-81, kat. br. 12.
19	GAR 15 PN 482	Consp. 24 (?)	?	□	SIC[---] / [---]		?	1. st. po. Kr.	Šimić-Kanaet 2021, str. 101, kat. br. 15.
20	GAR 07 PN 87		-	□	STATOR		La Graufesenque	15.-25. god. po. Kr.	Šimić-Kanaet 2017, str. 97, kat. br. 1.
21	zbirka S. Roguljić	Consp. 24.3.1.	?	□	TLORN / PTI [---]		?		Bekić 1998, str. 233, kat. br. 5, T. 1.7.
22	GAR 05 PN 372	Consp. 27	2335 (2249)	ipp	VEGET[---]		Padaska nizina	od 30. god. po. Kr	Šimić-Kanaet 2010, str. 80, kat. br. 5.
23	GAR 99 PN 22		846.6	ipp	[---]RTV		Padaska nizina	20. - 40. god. po. Kr.	Šimić-Kanaet, Zaninović 2007, str. 242.
24	GAR 01 PN 11		878 - 879	ipp	[---]LLI		Arezzo?	10. - 50. god. po. Kr.	Šimić-Kanaet, Zaninović 2007, str. 241.
25	GAR 03 PN 13		?	□	[---]AIS		?		Šimić-Kanaet 2010, str. 81, kat. br. 16.
26	GAR 04 PN 14	Consp. 37	?	ipp	[---]CE		?		Šimić-Kanaet 2010, str. 80, kat. br. 6.
27	GAR 02 1141		?	□	IA[---]		?		Šimić-Kanaet 2010, str. 81, kat. br. 14.
28	GAR 05 PN 414	Consp. 26/27	?	ipp	IV[---]		?	sr. 1. st. po. Kr.	Šimić-Kanaet 2010, str. 81, kat. br. 15.
29	zbirka S. Roguljić		?	□	?		?		Bekić 1998, str. 234, kat. br. 13, T. 4.9.
30	GAR 02 PN 1		?	□	?		?		Šimić-Kanaet 2010, str. 81, kat. br. 19.
31	GAR 18 PN 634	Consp. 14.4.1	?	□	?		?	prva pol. 1. st. po. Kr.	Šimić-Kanaet 2021, str. 104, kat. br. 31.
32	GAR 02 639		?	ipp	?		?		Šimić-Kanaet 2010, str. 81, kat. br. 17.
33	GAR 10 971	Consp. B 3.13	?	□	?		?		Šimić-Kanaet 2017, p. 101, cat. no. 36.

Tablica 3.

Pečati na glatkoj sigilati iz Tilurija

	Signature	Vessel form	OCK	Stamp form	Stamp	Graph-ite	Provenance	Dating	Literature
1	GAR 99 PN 2		?	□	AGM[---]		?		Šimić-Kanaet, Zaninović 2007, p. 242.
2	GAR 99 459		?	ipp	BOCCA		?	after 15 AD	Šimić-Kanaet, Zaninović 2007, p. 243.
3	GAR 04 PN 15	Consp. 26/27	485 (360)	ipp	CALMI		Po Valley	as of 15 AD	Šimić-Kanaet 2010, p. 80, cat. no. 7.
4	GAR 99 PN 5		696 (426)	ipp	C CRES		?	1 AD ?	Šimić-Kanaet, Zaninović 2007, p. 241.
5	GAR 04 PN 119	Consp. 22	514 (397) / 1200.4	ipp	CMVRI		Arezzo	30-70 AD	Šimić-Kanaet 2010, p. 80, cat. no. 8.
6	GAR 04 PN 64	Consp. 13	?	□	D[---] / [---]		?	1st c. AD	Šimić-Kanaet 2010, p. 90, cat. no. 110.
7	GAR 02 PN 11	Consp. 26/27	857 (719).6.	ipp	FVSCI		Po Valley	1-15 AD	Šimić-Kanaet 2010, p. 81, cat. no. 13.
8	GAR 09 PN 9	Consp. 22	894	□	GRAT		central Italy	1st c. AD	Šimić-Kanaet 2017, p. 100, cat. no. 31.
9	GAR 08 338	Consp. 36 (?)	?		M[---]		?	1st c. AD	Šimić-Kanaet 2017, p. 102, cat. no. 45.
10	GAR 02 PN 23	Consp. 26/27	1135 (983)	□	MELITO		Po Valley	1- 20 AD	Šimić-Kanaet 2010, p. 80, cat. no. 10.
11	GAR 99 VodPN 67		1267 (1121).3.	□	NICO	M	Po Valley	15 BC - 40 AD	Šimić-Kanaet, Zaninović 2007, p. 238.
12	GAR 02 PN 20	Consp. 24.3.1.	1267 (1121).3.	□	NICO		Po Valley	15 BC - 40 AD	Šimić-Kanaet 2010, p. 80, cat. no. 11.
13	GAR 98 PN 1		592 (454).14.	ipp	P CLO P		Arezzo	40-100 AD	Šimić-Kanaet, Zaninović 2007, p. 240.
14	GAR 99 VodPN 65		1782 (1655)	□	SARI	APTI	Po Valley	10 BC - 20 AD	Šimić-Kanaet, Zaninović 2007, p. 239.
15	GAR 09 PN 8		1782 (1655)	□	[---]ARI		Po Valley	10 BC - 20 AD	Šimić-Kanaet 2017, p. 102, cat. no. 44.
16	GAR 02 PN 31		1977 (1841).6	□	SO[---]		Po Valley	1-40 AD	Šimić-Kanaet 2010, p. 81, cat. no. 18.
17	GAR 15 PN 417	Consp. 18	1956 (1820)	ipp	SEV[---]		Po Valley	15 BC - 1 AD	Šimić-Kanaet 2021, p. 100, cat. no. 6.
18	GAR 02 PN 45	Consp. 7.1.3.	1956 (1820)	□	SEV[---]		Po Valley	15 BC - 1 AD	Šimić-Kanaet 2010, p. 80-81, cat. no. 12.
19	GAR 15 PN 482	Consp. 24 (?)	?	□	SIC[---] / [---]		?	1st c. AD	Šimić-Kanaet 2021, p. 101, cat. no. 15.
20	GAR 07 PN 87		-	□	STATOR		La Graufesenque	15-25 AD	Šimić-Kanaet 2017, p. 97, cat. no. 1.
21	S. Roguljić collection	Consp. 24.3.1.	?	□	TLORN / PTI [---]		?		Bekić 1998, p. 233, cat. no. 5, T. 1.7.
22	GAR 05 PN 372	Consp. 27	2335 (2249)	ipp	VEGET[---]		Po Valley	as of 30 AD	Šimić-Kanaet 2010, p. 80, cat. no. 5.
23	GAR 99 PN 22		846.6	ipp	[---]RTV		Po Valley	20-40 AD	Šimić-Kanaet, Zaninović 2007, p. 242.
24	GAR 01 PN 11		878 - 879	ipp	[---]LLI		Arezzo?	10-50 AD	Šimić-Kanaet, Zaninović 2007, p. 241.
25	GAR 03 PN 13		?	□	[---]AIS		?		Šimić-Kanaet 2010, p. 81, cat. no. 16.
26	GAR 04 PN 14	Consp. 37	?	ipp	[---]JCE		?		Šimić-Kanaet 2010, p. 80, cat. no. 6.
27	GAR 02 1141		?	□	IA[---]		?		Šimić-Kanaet 2010, p. 81, cat. no. 14.
28	GAR 05 PN 414	Consp. 26/27	?	ipp	IV[---]		?	mid-1st c. AD	Šimić-Kanaet 2010, p. 81, cat. no. 15.
29	S. Roguljić collection		?	□	?		?		Bekić 1998, p. 234, cat. no. 13, T. 4.9.
30	GAR 02 PN 1		?	□	?		?		Šimić-Kanaet 2010, p. 81, cat. no. 19.
31	GAR 18 PN 634	Consp. 14.4.1	?	□	?		?	first half of 1st c. AD	Šimić-Kanaet 2021, p. 104, cat. no. 31.
32	GAR 02 639		?	ipp	?		?		Šimić-Kanaet 2010, p. 81, cat. no. 17.
33	GAR 10 971	Consp. B 3.13	?	□	?		?		Šimić-Kanaet 2017, p. 101, cat. no. 36.

Table 3.

Stamps on plain sigillata from Tilverium

Na dnu šalice oblika *Consp. 22* smješten je pečat GRAT (tab. 3. 8; T. 4. 8), koji se pripisuje M. Gratiđiju (*M. Gratiđivs*), lončaru koji je početkom stoljeća djelovao na području srednje Italije.¹⁰⁴ Analogije nalazimo u uvali Caska na otoku Pagu.¹⁰⁵ Na području Italije djelovao je i lončar C. *Crestivs*¹⁰⁶ kojem bi mogli pripisati pečat CCRES utisnut na dnu posude iz Tilurija (tab. 3. 4; T. 4. 4).

Galskom proizvodnom središtu možemo pripisati samo jedan pečat s natpisom *STATOR*, utisnut na dnu tanjura unutar pravokutnog polja (tab. 3. 20; T. 5. 20). Riječ je o lončaru koji je djelovao u južnogalskoj radionici *La Graufesenque* u vremenu od oko 15. do 25. god. po. Kr.¹⁰⁷

Pečatima *BOCCA* (tab. 3. 2; T. 4. 2) i *TLORN / PTI* (tab. 3. 21; T. 5. 21) ne nalazimo analogije.

Na reljefnoj sigilati pronađeno je pet pečata. Reljefno ukrašena *terra sigillata* obuhvaća crveno premazano stolno posuđe izrađeno u kalupu, čime je omogućeno reljefno ukrašavanje stijenki. Među proizvodima sjevernoitalske produkcije ističu se tzv. *Aco* čaše i *Sarius* šalice, koje su zastupljene u većem broju među tilurijskom keramičkom građom. U dosadašnjim istraživanjima dokumentirano je šezdesetak ulomaka šalice tipa *Sarius*¹⁰⁸, od kojih četiri sadrže dijelove natpisa majstora utisnute unutar reljefne dekoracije. Unutar reljefne vegetabilne dekoracije izveden je u dva retka pečat s natpisom *L. SARI / CLEM* (T. 6. 39), gdje bi prvo ime označavalo majstora *L. Sarivs Srvvs-a*, a drugo *Clemens-a*.¹⁰⁹ Proizvodnju tzv. *Sarius* šalice započinje majstor *L. Sarivs Srvvs* oko 20. god. pr. Kr. na području sjeverne Italije, a potom su s proizvodnjom do sredine 1. st. po. Kr. nastavile i druge radionice, među kojima treba istaknuti majstore pod imenom *Clemens*, *Hilarus*, *A. Terentius* i *Sipai*.¹¹⁰ S obzirom da su na tilurijskom pečatu zabilježena imena majstora iz dvije različite faze proizvodnje, Z. Šimić-Kanaet pretpostavlja kako su “možda u jednoj fazi rada imali zajedničku radionicu” u kojoj “lončar *Sarius* radi u zajedničkoj radionici uz lončara *Clemensa*”.¹¹¹ Na preostala tri ulomka sačuvana su samo pojedinačna slova [---]S[---], [---]N[---] i [---]E[---]N[---] utisnuta unutar reljefne dekoracije, koja bi se mogla pripisati majstoru *Clemensu* (T. 6. 40-42).¹¹² Riječ je o majstoru koji je djelovao na području Akvileje između 10. god. pr. Kr. i sredine 1. st. po. Kr. te je distribuirao proizvode duž istočne obale Jadrana.¹¹³ Manjim

This was a workshop that is represented in a high number of stamps in the eastern Adriatic seaboard, to which finds from Nin, Zadar, Osor, Krk, Burnum, Salona, the Sinj environs and Naronna testify.¹⁰¹ Given their *planta pedis* form, the stamps from Tilurium may be dated to after 15 AD. The stamp *CMVRI* (tab. 3. 5; Pl. 4. 5), impressed on a *Consp. 22* type cup, belongs to the *Camvrivs* or *C. Mvrivs* workshop, which most likely functioned in the Arezzo area from 30 to 70 AD.¹⁰² The third example belongs to the potter P. Claudius Proculus (*P. Clodivs Procvlvs*), whose activity may be dated between 40 and 100 AD (tab. 3. 13; Pl. 4. 13).¹⁰³

The bottom of a *Consp. 22* cup contains the stamp GRAT (tab. 3. 8; Pl. 4. 8), which has been attributed to M. Gratiđius (*M. Gratiđivs*), a potter who was active in northern Italy at the beginning of the century.¹⁰⁴ Analogies can be found in Caska Cove on the island of Pag.¹⁰⁵ The potter C. Crestius (*Crestivs*)¹⁰⁶ was also active in northern Italy, and the stamp CCRES impressed on the bottom of a vessel from Tilurium (tab. 3.4; Pl. 4. 4) may be attributed to him.

Only one stamp bearing the inscription *STATOR*, impressed on the bottom of a plate inside a rectangular field (tab. 3. 20; Pl. 5. 20) may be attributed to a Gallic production centre. This is a potter who was active in the southern Gallic workshop known as *La Graufesenque* during the period from roughly 15 through 25 AD.¹⁰⁷

No analogies can be found for the stamps *BOCCA* (tab. 3. 2; Pl. 4. 2) and *TLORN/PTI* (tab. 3. 21; Pl. 5. 21).

Five stamps have been found on relief *sigillata*. *Terra sigillata* decorated in relief encompasses red-slipped tableware made in a mould, thus enabling relief decoration of its walls. Among the products of north Italic manufacture, the so-called *Aco* beakers and *Sarius* cups stand out. They account for a high number of the Tilurium ceramic materials. In previous excavations, sixty sherds of *Sarius*-type cups have been documented,¹⁰⁸ of which four contain parts of the inscription of the master craftsman impressed into relief decorations. Inside a relief vegetable decoration, a stamp is rendered in two lines with the inscription *L. SARI/CLEM* (Pl. 6. 39), wherein the first

104 OCK, str. 240, tip 894.

105 Grisonic, Stepan 2017, str. 88, T. V, 52.

106 OCK, str. 203, tip 696 (426).

107 Genin 2000, str. 246, br. 406; Gavrielatos 2012, str. 261.

108 Šimić-Kanaet 2017, str. 81; Šimić-Kanaet 2021.

109 Šimić-Kanaet 2003a, kat. br. 40.

110 Borzić 2011, str. 283, bilj. 1.

111 Šimić-Kanaet 2003a, str. 118, kat. br. 40.

112 Šimić-Kanaet 2017, kat. br. 46-47; Šimić-Kanaet 2021, kat. br. 21.

113 Borzić 2013, str. 141-142. Detaljnije o tzv. *Sarius* šalicama iz Tilurija i Burna te ostalim lokalitetima na kojima su pronađene vidi: Šimić-Kanaet 2004; Borzić 2011; Borzić 2020, str. 47-58.

101 Nin: Borzić *et al.* 2013, p. 41, cat. no. B1; Zadar: Prtenjača 2011, p. 64, cat. no. 1; Osor: Makjanić 1985, p. 43; Krk-Šinigoj: Konestra 2015, p. 589, no. 11-17; Burnum: Borzić 2013, p. 145, tab. 1, no. 14-17; Borzić 2020, p. 37, tab. 1; Salona: Clairmont *et al.* 1975, pp. 95, 101, 105; Sinj vicinity: Babić 2008, p. 192, cat. no. 18, 19; Naronna: Topić 2003, p. 190.

102 OCK, p. 173, type 514 (397) or OCK, p. 287, p. 1200.4. Analogies can be found in Naronna (Topić 2003, p. 190).

103 OCK, p. 186, type 592 (454).¹⁴

104 OCK, p. 240, type 894.

105 Grisonic, Stepan 2017, p. 88, Pl. V, 52.

106 OCK, p. 203, type 696 (426).

107 Genin 2000, p. 246, no. 406; Gavrielatos 2012, p. 261.

108 Šimić-Kanaet 2017, p. 81; Šimić-Kanaet 2021.

brojem primjeraka zastupljene su čaše tipa *Aco*, koje se datiraju između kraja 1. st. pr. Kr. i sredine 1. st. po. Kr.¹¹⁴ Dosadašnjim istraživanjima u Tiluriju izdvojeno je sveukupno 13 ulomaka koji se mogu pripisati čašama tipa *Aco*.¹¹⁵ Među njima je jedan ulomak koji sadrži slova *HI* smještena uz vegetabilni reljefni ukras (T. 6. 43).¹¹⁶ Natpis se može pripisati majstoru Hilarusu (*Hilarus*), koji je djelovao između 20. god. pr. Kr. i 10. god. po. Kr., a izrađivao je istovremeno tzv. *Aco* i *Sarius* proizvode.¹¹⁷

name denotes the potter *L. Sarius Srvs*, and the other *Clemens*.¹⁰⁹ Production of the so-called *Sarius* cups originated with the potter *L. Sarius Surus* in northern Italy at roughly 20 BC, and then this production was continued until the mid-1st century AD by other workshops, among which the potters named *Clemens*, *Hilarus*, *A. Terentius* and *Sipai* should be noted.¹¹⁰ Given that the names of potters from two different production phases are recorded on the Tilurium stamp, Z. Šimić-Kanaet assumed that they “perhaps had a common workshop at some phase” in which “the potter *Sarius* worked in a common workshop with the potter *Clemens*.”¹¹¹ On the remaining three sherds, only the individual letters [---]S[---], [---]N[---] and [---]E[---]N[---] impressed inside relief decorations have been preserved. They could be attributed to the potter *Clemens* (Pl. 6. 40-42).¹¹² He was a craftsman who was active in the Aquileia area between 10 BC and the mid-1st century AD, and his products were distributed throughout the eastern Adriatic seaboard.¹¹³ *Aco*-type beakers, which may be dated between the end of the 1st century BC and the mid-1st century AD, are present in a smaller number of examples.¹¹⁴ In the course of previous excavations in Tilurium, a total of 13 sherds that may be attributed to *Aco*-type beakers may be distinguished.¹¹⁵ Among them, there is one sherd which bears the letters *HI* inside a relief plant decoration (Pl. 6. 43).¹¹⁶ The inscription may be attributed to the potter *Hilarus*, who was active between 20 BC and 10 AD, and he simultaneously crafted so-called *Aco* and *Sarius* products.¹¹⁷

114 *Conspectus* 2002, str. 182

115 Šimić-Kanaet 2010, str. 25; Šimić-Kanaet 2017, str. 82; Šimić-Kanaet 2021.

116 Šimić-Kanaet 2021, kat. br. 28.

117 OCK, str. 29. Analogije pečatu nalazimo u Osoru (Konestra 2015, str. 326).

109 Šimić-Kanaet 2003a, cat. no. 40.

110 Borzić 2011, p. 283, note 1.

111 Šimić-Kanaet 2003a, p. 118, cat. no. 40.

112 Šimić-Kanaet 2017, cat. no. 46-47; Šimić-Kanaet 2021, cat. no. 21.

113 Borzić 2013, pp. 141-142. For more details on so-called *Sarius* cups from Tilurium and Burnum and other sites at which they were found, see: Šimić-Kanaet 2004; Borzić 2011; Borzić 2020, pp. 47-58.

114 *Conspectus* 2002, p. 182

115 Šimić-Kanaet 2010, p. 25; Šimić-Kanaet 2017, p. 82; Šimić-Kanaet 2021.

116 Šimić-Kanaet 2021, cat. no. 28.

117 OCK, p. 29. Analogies to the stamp can be found in Osor (Konestra 2015, p. 326).

PEČATI NA OSTALIM KERAMIČKIM POSUDAMA (T. 7)

Osim u sigilatnoj varijanti, čaše tipa *Aco* javljaju se i u nepremazanoj varijanti, odnosno u formi keramike tankih stijenki. Ulomak jedne takve čaše pronađen je i u Tiluriju, a sadrži natpis [---]ES CV[---] smješten ispod vegetabilnog friza (T. 7. 1).¹¹⁸ Pečat nalazimo i na ulomku jednog tarionika, gdje je na izvučenom rubu unutar pravokutnog polja utisnuto slovo A[---] (T. 7. 2).¹¹⁹ Nažalost, preostali dio pečata nije sačuvan. Među mnogobrojnim ulomcima keramičkih svjetiljaka iz Tilurija zastupljen je samo jedan ulomak s natpisom (T. 7. 3) koji pripada svjetiljkama s pečatom (*Firmalampen*).¹²⁰ Riječ je o pečatu radionice *FORTIS* (L. *Aemilius Fortis*), sjevernoitalskog majstora koji je djelovao u okolici Modene (Savignano sul Panaro) u drugoj polovici 1. st. po. Kr.¹²¹ Proizvodnja se nastavila tijekom 2. st. po. Kr. u manjim lokalnim radionicama izvan Italije, jedna od kojih je vjerojatno bila i Fažana u Istri.¹²² Ulomak vrata i dijela stijenke vrča sadrži urezan grafit [---]MIN[---] (T. 7. 4).¹²³ Grafit nažalost nije sačuvan u cijelosti.

NATPISI NA STAKLENIM POSUDAMA (T. 7)

Dva manja ulomka prozirnog tamnog stakla jantarne boje sadrže djelomično sačuvani natpis, no fragmentiranost ulomaka onemogućuje utvrđivanje tipa posude i provedbu rekonstrukcije natpisa. Prvi ulomak sadrži dva u nizu sačuvana slova: zrcalno L, nakon kojeg se nalazi oštećeno slovo E ili F (T. 7. 5), dok drugi ulomak sadrži oštećeno slovo I? pa E (T. 7. 6).¹²⁴ Ulomke bismo mogli datirati od kraja 1. do kraja 2. st. po. Kr.¹²⁵ Time oni spadaju u razdoblje kada Tilurij nakon odlaska VII. legije više nije bio legijski logor, ali je ostao rimsko vojno uporište što potvrđuju natpisi pomoćnih postrojbi datirani sve do sredine 3. stoljeća.

Za razliku od potonjih, slova na ulomku cilindričnog tijela bezbojnog stakla zelenkastog odsjaja moguće je pročitati kao dio natpisa na grčkom alfabetu ENNION / ΕΠΟΙΕΙ („Enion me načinio“) (T. 7. 7).¹²⁶ Natpis je smješten unutar polja oblika *tabula ansata*, a izveden je u dva retka, gdje je u prvome sačuvano slovo N, a u drugome slovo I. Ulomak bi mogao pripadati čaši s dvije ručke, tipa *Harden* Aziv i De Bellisovoj skupini 3,

STAMPS ON OTHER CERAMIC VESSELS (PL. 7)

Besides the *terra sigillata* variant, *Aco*-type beakers also appeared in the unslipped variety, i.e., in the form of thin-walled ceramics. A sherd of one such beaker was also found in Tilurium, and it bears the inscription [---]ES CV[---] situated below a vegetable frieze (Pl. 7. 1).¹¹⁸ The stamp can also be found on a sherd of a mortarium, where on the outwardly drawn rim the letter A[---] (Pl. 7. 2) is impressed in a rectangular field.¹¹⁹ Unfortunately, the remaining part of the stamp has not been preserved. Among the numerous sherds of ceramic oil-lamps from Tilurium, there is only one with an inscription (Pl. 7. 3) which belongs to the category of stamped oil-lamps (*Firmalampen*).¹²⁰ This is the stamp of the *FORTIS* (L. *Aemilius Fortis*) workshop of the northern Italic potter who operated in the vicinity of Modena (Savignano sul Panaro) in the latter half of the 1st century AD.¹²¹ Production continued during the 2nd century AD in small local workshops outside of Italy, one of which was probably also in Fažana in Istria.¹²² A sherd of the neck and part of the wall of a jug bears the graffito [---]MIN[---] (Pl. 7. 4).¹²³ The graffito has not, unfortunately, been preserved in its entirety.

INSCRIPTIONS ON GLASS VESSELS (PL. 7)

Two small sherds of dark amber-coloured glass contain a partially preserved inscription, but the fragmentary condition of the sherds makes it impossible to determine the vessel type or reconstruct the inscription. The first sherd contains two in the series of preserved letters: a mirror-image L, followed by a damaged E or F (Pl. 7. 5), while the other sherd contains a damaged letter I (?) followed by an E (Pl. 7. 6).¹²⁴ The sherds may be dated from the end of the 1st to the end of the 2nd century AD.¹²⁵ They thus belong to the period when Tilurium, after the departure of Legio VII, was no longer a legionary fortress, but remained a Roman military stronghold, as confirmed by inscriptions of auxiliary units dated up to the mid-3rd century.

As opposed to the latter, the letters on a sherd of a cylindrical body of colourless glass with green shine may be interpreted as part of an inscription written in Greek ENNION/ ΕΠΟΙΕΙ (“Ennion made me”) (Pl. 7. 7).¹²⁶ The inscription is sit-

118 Šimić-Kanaet 2003a, str. 149.

119 Šimić-Kanaet 2010, str. 327, kat. br. 2764.

120 Šimić-Kanaet 2011, str. 192, kat. br. 24, T. 3. 13 = MCK-B-1098. O zastupljenim tipovima svjetiljki iz Tilurija vidi: Matijević, Šimić-Kanaet 2020.

121 Buchi 1975, str. 67-70.

122 Starac 1994, str. 8.

123 Šimić-Kanaet 2021, kat. br. 128.

124 Buljević 2014, str. 259, kat. br. 194, 195.

125 Buljević 2014, str. 259.

126 Buljević 2014, kat. br. 189.

118 Šimić-Kanaet 2003a, p. 149.

119 Šimić-Kanaet 2010, p. 327, cat. no. 2764.

120 Šimić-Kanaet 2011, p. 192, cat. no. 24, Pl. 3. 13 = MCK-B-1098. On oil-lamp types present in Tilurium, see: Matijević, Šimić-Kanaet 2020.

121 Buchi 1975, p. 67-70.

122 Starac 1994, p. 8.

123 Šimić-Kanaet 2021, cat. no. 128.

124 Buljević 2014, p. 259, cat. no. 194, 195.

125 Buljević 2014, p. 259.

126 Buljević 2014, cat. no. 189.

kakvoj analogije nalazimo u Pollenzu, Caresani i nepoznatom sjevernoitalskom nalazištu. Posuđe s potpisom Eniona, puhača stakla u kalup koji je djelovao na sirijsko-palestinskom području, datira se u prvu polovicu 1. st. po. Kr.¹²⁷ Pronađeno je diljem Mediterana i na sjevernoj obali Crnog mora, dok je na području rimske provincije Dalmacije zastupljeno još primjercima iz amfiteatra i vježbališta u Burnu te temenosa Augusteja u Naroni.¹²⁸ Zaštitnim istraživanjima na položaju Željeznički kolodvor u Sisku Enionovi proizvodi prvi put su potvrđeni i u Sisciji.¹²⁹

GEME S NATPISOM

S Garduna nam je poznat velik broj gema, koje su tijekom 19. i 20. st. kao slučajni nalazi otkupljene za muzejske zbirke. Geme su pohranjene u raznim muzejskim ustanovama u Hrvatskoj i inozemstvu, gdje najveću zbirku, sa 238 ulomaka, predstavlja ona u Arheološkome muzeju u Splitu. Geme iz Tilurija pohranjene su još i u Muzeju Cetinske krajine u Sinju i u Arheološkome muzeju u Zagrebu, kao i u nekoliko privatnih zbirki, među kojima treba izdvojiti zbirku Sir Arthura Evansa.¹³⁰ Među mnogobrojnom glitpičkom građom iz Tilurija nalaze se i četiri game s prikazima, uz koje je ugraviran natpis.

Crveni karneol (sl. 1) prikazuje božicu Veneru, čije nago tijelo prati ikonografiju tzv. sramežljive Venere (*Venera pudica*).¹³¹ Uz Veneru je izveden natpis na grčkom alfabetu *KOPINΘOY*, sa značenjem "iz Korinta". Gema se nalazi u privatnoj zbirci Arthura Evansa koju je objavila Sheila Hoey Middleton. Autorica ukazuje na mogućnost da je gema donesena kao suvenir iz Korinta, gdje se nalazio Afroditin hram, u koji su često dolazile prostitutke, te ju datira u 1. st. po. Kr.¹³²

U Arheološkome muzeju u Zagrebu pohranjen je intaljo (sl. 2) izrađen od žutog stakla koji sadrži natpis *HAVE*, izveden u negativu.¹³³ Radi se o inačici riječi *AVE* sa značenjem "pozdrav", kakvoj analogije nalazimo na primjeru iz Vendeuil-Caply u Francuskoj.¹³⁴ Intaljo možemo datirati u 1. st. po. Kr.

uated inside a *tabula ansata* field, and rendered in two lines, in which the letter *N* is preserved in the first, and the letter *I* in the second. The sherd may have belonged to a beaker with two handles, *Harden* type Aziv and *De Bellis* group 3, for which analogies can be found in Pollenzo, Caresana and an unknown northern Italian site. Vessels bearing the signature of Ennion, a mould glass-blower who operated in the Syria-Palestine area, date to the first half of the 1st century AD.¹²⁷ They have been found throughout the Mediterranean and on the northern shore of the Black Sea, while in the territory of the Roman province of Dalmatia, they are examples from the amphitheatre and training ground in Burnum and the temenos of the Augusteum in Narona.¹²⁸ Ennion's products were confirmed in Siscia for the first time after rescue excavations at the Train Station in Sisak.¹²⁹

GEMS WITH INSCRIPTIONS

A high number of gems were found at Gardun, and during the 19th and 20th centuries they were gathered in museum collections as chance finds. The gems are held in various museum institutions in Croatia and abroad, wherein the largest collection, with 238 pieces, is that of the Archaeological Museum in Split. The gems from Tilurium are also stored in the Cetina Territorial Museum in Sinj and the Archaeological Museum in Zagreb, as well as several private collections, among which the collection of Sir Arthur Evans is particularly noteworthy.¹³⁰ Among the extensive glyptic materials from Tilurium, there are four gems with images accompanied by an engraved inscription.

A red carnelian (Fig. 1) shows the goddess Venus, whose nude body adheres to the iconography of the so-called modest Venus (*Venera pudica*).¹³¹ Venus is accompanied by an inscription in Greek script, *KOPINΘOY*, with the meaning 'from Corinth'. The gem is held in the Arthur Evans private collection, which was published by Sheila Hoey Middleton. She posited the possibility that the gem was brought as a souvenir from Corinth, where there was a temple of Aphrodite that was

127 Buljević 2012, str. 11, sl. 7; Buljević 2014, kat. br. 189.

128 Buljević 2012, str. 3-19.

129 Buljević 2020, str. 44.

130 Geme iz Garduna u Arheološkom muzeju Splitu publicirao je don Frane Bulić u razdoblju od 1879. do 1926. god. u muzejskom časopisu *Bullettino di archeologia e storia Dalmata*, da bi potom zbirku u cijelosti objavila Bruna Nardelli 2011. god. (Nardelli 2011). Geme iz Arheološkog muzeja u Zagrebu, Muzeja Cetinske krajine u Sinju i privatne zbirke Stipe i Martina Roguljića iz Garduna objavila je Iva Kaić. Vidi: Kaić 2010; Kaić 2014; Kaić 2017.

131 Privatna zbirka A. Evans; dimenzije: 12 mm x 10 mm x 2 mm (Hoey Middleton 1991, str. 61, br. 68).

132 Hoey Middleton 1991, str. 61, br. 68; Kaić 2018, str. 1047, sl. 3.

133 Arheološki muzej u Zagrebu, inv. br. A-15957; dimenzije: 6,5 x 8,3 x 1,3 mm. Kupljeno od Mate Žuljevića 1911. god. (Kaić 2013, str. 303, kat. br. 399; Kaić 2017, str. 483, sl. 8).

134 Kaić 2017, str. 483.

127 Buljević 2012, p. 11, fig. 7; Buljević 2014, cat. no. 189.

128 Buljević 2012, pp. 3-19.

129 Buljević 2020, p. 44.

130 The gems from Gardun in the Archaeological Museum in Split were published by Fr. Frane Bulić from 1879 through 1925 in the museum's journal *Bullettino di archeologia e storia Dalmata*, and then the entire collection was published by Bruna Nardelli in 2011 (Nardelli 2011). The gems from the Archaeological Museum in Zagreb, the Cetina Territorial Museum in Sinj and the private collection of Stipe and Martin Roguljić from Gardun were published by Iva Kaić. See: Kaić 2010; Kaić 2014; Kaić 2017.

131 Private collection of Arthur Evans; dimensions: 12 mm x 10 mm x 2 mm (Hoey Middleton 1991, p. 61, no. 68).



Slika 1.
Crveni karneol s natpisom
KOPINΘOY, privatna zbirka A.
Evans (preuzeto iz Kaić 2018,
str. 1047, sl. 3)

Figure 1.
A red carnelian bearing the
inscription KOPINΘOY, private
collection of A. Evans (taken
from Kaić 2018, p. 1047, Fig. 3)

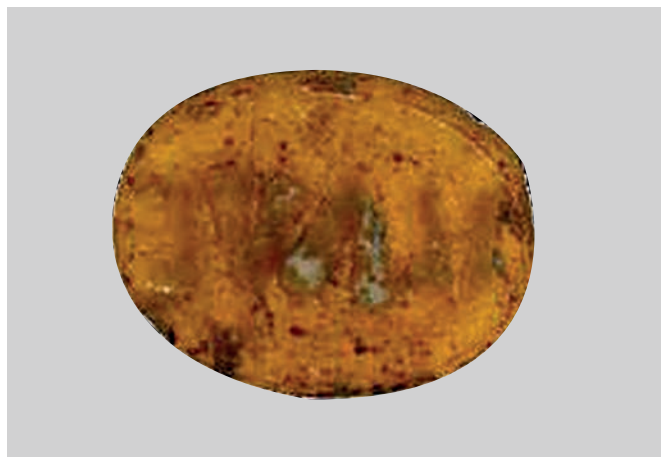

Slika 2.
Intaljo s natpisom HAVE u
negativu, Arheološki muzej
u Zagrebu, inv. br. A-15957
(preuzeto iz Kaić 2017, str.
483, sl. 8)

Figure 2.
An intaglio bearing the
inscription HAVE in the
negative, Archaeological
Museum in Zagreb, inv. no.
A-15957 (taken from Kaić 2017,
p. 483, Fig. 8)



Slika 3.
Kalcedon heliotrop s natpisom
XAI, Arheološki muzej u
Splitu, inv. br. I-936 (foto:
Arhiva AMS)

Figure 3.
Chalcedony heliotrope
bearing the inscription XAI,
Archaeological Museum in
Split, inv. no. I-936 (photo:
AMS Archive)



Slika 4.
Sivi jaspis s natpisom DA MA,
Arheološki muzej u Splitu,
inv. br. I-422 (foto: Arhiva AMS)

Figure 4.
A grey jasper bearing
the inscription DA MA,
Archaeological Museum in
Split, inv. no. I-422 (photo:
AMS Archive)

Natpis se nalazi i na dvjema gemama pohranjenima u Arheološkome muzeju u Splitu. Kalcedon heliotrop (sl. 3) prikazuje dvije Tihe u činu rukovanja, iznad su poprsja Merkura i Atene okrenuta jedno prema drugom, a ispod dvije ruke sklopljene u gesti *dextrarium iunctio* s natpisom XAI.¹³⁵ Bruna Nardelli u natpisu prepoznaje XARA, izraz za radost, kakav se javlja na

frequented by prostitutes, and dated to the 1st century AD.¹³²

An intaglio (Fig. 2) made of yellow glass bearing the inscription HAVE, rendered in the negative,¹³³ is stored in the Archaeological Museum in Zagreb. This is a variant of the word AVE, meaning “greetings,” to which there are analogies from

¹³⁵ AMS I-936; dimenzije: 12,5 x 11,8 x 3,1 mm. CIL III 13344; Bulić 1889, str. 117, br. 936; Nardelli 2011, str. 269, sl. 9.

¹³² Hoey Middleton 1991, p. 61, no. 68; Kaić 2018, p. 1047, fig. 3.

¹³³ Archaeological Museum in Zagreb, inv. no. A-15957; dimensions: 6,5 x 8,3 x 1,3 mm. Purchased from Mate Žuljević in 1911 (Kaić 2013, p. 303, cat. no. 399; Kaić 2017, p. 483, fig. 8).

lokalitetu Gadara u Jordanu.¹³⁶ Sivi jaspis (sl. 4) prikazuje falus, omeđen slovima *DA MA*.¹³⁷

NATPISI NA KOŠTANIM PREDMETIMA (T. 7)

U dosadašnjim istraživanjima legijskog logora Tilurija dokumentirana su tri koštana predmeta s natpisima. Jedna kocka i jedna tesera pripadaju predmetima za igru. Na kocki su brojčane vrijednosti izvedene u obliku točaka koje su okružene dvjema koncentričnim kružnicama izvedenima tordiranjem (T. 7. 8). Zbroj vrijednosti prikazan na suprotnim stranama kocke iznosi sedam.¹³⁸ Na obodu tesere (T. 7. 9) nalazi se žlijeb "V" presjeka. Rub tesere s obje je strane ukrašen trostrukom profilacijom unutar koje je urezan natpis. Na prednjoj strani je broj *XII*, a na stražnjoj slova *I · B*.¹³⁹ Namjena ovakvih tesera različito se tumači, primjerice kao ulaznica za teatar ili kao žeton za besplatne obroke žita.¹⁴⁰ Pojedini primjerci, pogotovo oni s različitim kombinacijama rimskih i grčkih brojeva, interpretiraju se i kao žetoni za igru.¹⁴¹ U tom smislu se natpis na obje strane tilurijske tesere može čitati kao rimski i grčki broj 12. Za pojedine primjerke tesera predložena je i interpretacija kontrolne marke u vrećici s novcem, a takve vrećice označavale bi tzv. *tesserae nummulariae*.¹⁴² *Tesserae nummulariae* su male koštane pločice koje su između 96. god. pr. Kr. i 88. god. po. Kr. služile kao etikete na vrećicama s novcem. U Tiluriju je dokumentiran jedan koštani predmet koji se uvjetno može tumačiti kao *tessera nummularia*, ali se radi o slučajnom nalazu koji nije povezan s prethodno opisanom tesorom.¹⁴³ Riječ je o predmetu pravokutnog presjeka, dimenzija 1 x 0,4 x 4 cm, pri čemu na lijevom kraju nije sačuvana karakteristična profilacija u obliku anse koja sadrži ušicu (T. 7. 10). Natpis na jednoj strani glasi *X*, a na drugoj *OPE*. U pravilu se na sve četiri strane nalazi natpis – 1. ime numularija; 2. kod robova i oslobođenika ime vlasnika ili patrona; 3. oznaka provjere s danom i mjesecom i 4. konzularna godina. Postoje doduše i pločice na kojima nedostaju podatci o provjeri i datumu. Također postoje primjeri brisanja izvornog natpisa i urezivanja novog.¹⁴⁴

Vendeuil-Caply in France.¹³⁴ The intaglio may be dated to the 1st century AD.

Inscriptions can also be found on two gems stored in the Archaeological Museum in Split. A chalcedony heliotrope (Fig. 3) bears a depiction of a two Tychae shaking hands, above busts of Mercury and Athena facing each other, and below two hands clasped in the *dextrarium iunctio* gesture with the inscription *XII*.¹³⁵ Bruna Nardelli recognized in it *XARA*, an expression of joy, which appeared at the Gadara site in Jordan.¹³⁶ A grey jasper (Fig. 4) bears an image of a phallus, framed by the letters *DA MA*.¹³⁷

INSCRIPTIONS ON BONE (PL. 7)

In previous excavations at the legionary fortress in Tilurium, three bone items bearing inscriptions were documented. A die and tessera are gaming items. The die features numerical values rendered in the form of dots surrounded by two concentric circlets rendered in a spiral (Pl. 7. 8). The sum of the numerical values indicated on the various sides is seven.¹³⁸ The edge of the tessera (Pl. 7. 9) has a groove with a V cross-section. The tessera's edge is adorned on both sides with triple moulding inside which an inscription is engraved. The number *XII* is on the front, and the letters *I · B* are on the reverse.¹³⁹ The purpose of such tesserae has been variously interpreted as, for example, admission passes to the theatre or tokens for a free meal of grain.¹⁴⁰ Individual examples, particularly with different combinations of Roman and Greek numerals, have also been interpreted as gaming tokens.¹⁴¹ In this sense, the inscription on both sides of the Tilurium tessera may be read as the Roman and Greek number 12. Another interpretation suggested for individual examples of tesserae is that they were control stamps on sacks of coins, as such sacks were marked with so-called *tesserae nummulariae*.¹⁴² *Tesserae nummulariae* are small bone tiles that were used between 96 BC and 88 AD as labels on coin sacks. A bone item was documented in Tilurium which may be provisionally interpreted as a *tessera nummularia*, but it was a chance find not connected to the aforementioned tessera.¹⁴³ This is an item with rectan-

136 Nardelli 2011, str. 269.

137 AMS I-422; dimenzije: 16 x 12 mm. CIL III 10188.12; Bulić 1887, str. 77, br. 422.

138 Tončinić 2003, str. 259 i 262, kat. br. 4.

139 Tončinić 2003, str. 259 i 263, kat. br. 7.

140 Kos 1998, str. 345.

141 Kos 1998, str. 345; Gostenčnik 2005, str. 188-189.

142 Gostenčnik 2005, str. 185.

143 Bekić 1998, str. 234, br. 33, T. 2. 2.

144 Gostenčnik 2005, str. 248-261.

134 Kaić 2017, p. 483.

135 AMS I-936; dimensions: 12.5 x 11.8 x 3.1 mm. CIL III 13344; Bulić 1889, p. 117, no. 936; Nardelli 2011, p. 269, fig. 9.

136 Nardelli 2011, p. 269.

137 AMS I-422; dimensions: 16 x 12 mm. CIL III 10188.12; Bulić 1887, p. 77, no. 422.

138 Tončinić 2003, pp. 259 and 262, cat. no. 4.

139 Tončinić 2003, pp. 259 and 263, cat. no. 7.

140 Kos 1998, p. 345.

141 Kos 1998, p. 345; Gostenčnik 2005, pp. 188-189.

142 Gostenčnik 2005, p. 185.

143 Bekić 1998, p. 234, no. 33, Pl. 2. 2.

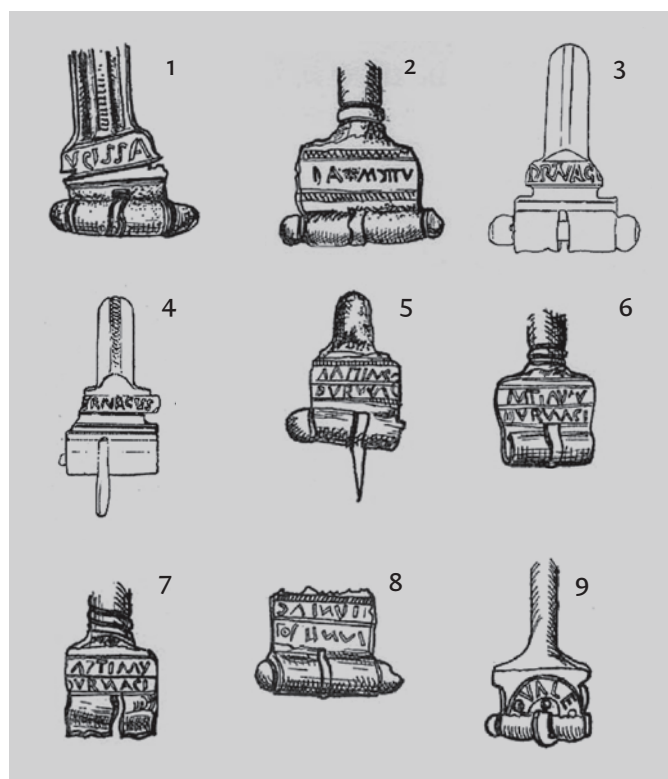

Slika 5.
Natpisi na Aucissa fibulama
iz Tilurija

Figure 5.
Inscriptions on Aucissa fibulae
from Tilurium

NATPISI NA FIBULAMA (TAB. 4)

Među fibulama iz Tilurija najbrojniju skupinu čine fibule *Aucissa*.¹⁴⁵ Riječ je o vojničkim fibulama koje su dobro zastupljene na rimskim vojnim nalazištima od posljednje četvrtine 1. st. pr. Kr. do kraja 1. st. po. Kr. Njihova se datacija time uvelike preklapa s datacijom Tilurija kao rimskoga legijskog logora. *Aucissa* fibule ujedno predstavljaju i najbrojniju skupina metalnih predmeta s natpisima u Tiluriju. Na zaglavnoj ploči 20 fibula dokumentirano je ukupno šest različitih natpisa. Natpis *Aucissa* javlja se u varijantama *AVCISSA* (tab. 4. 1), odnosno *[AVCI]SSA* (tab. 4. 2) i *VCISSA* (tab. 4. 3; sl. 5. 1). Na po jednoj fibuli iz Tilurija zastupljeni su natpisi *CARTILIUS* (tab. 4. 4), *CA[RTILIA]* (tab. 4. 5) i *DAGOMATTUS* (tab. 4. 6; sl. 5. 2). Najzastupljeniji je natpis *Durnacus*, s varijantama *DVRNACV*¹⁴⁶ (tab. 4. 7-8), *VRNACV* (tab. 4. 9), *RNACVS* (tab. 4. 10), *DVRNACO* (tab. 4. 11-12), *[D]VRNACVS* (tab. 4. 13; sl. 5. 3), *DRNACV[S]* (tab. 4. 14; sl. 5. 4). S ukupno osam *Aucissa* fibula s natpisom *Durnacus* Tilurij predstavlja mjesto s najvećim brojem nalaza fibula ovog tipa u Dalmaciji, no to nije dovoljno za pretpostavku o njihovoj

gular cross-section, dimensions of 1 x 0.4 x 4 cm, on which the typical ansa-shaped moulding on the left edge containing an eyehole has not been preserved (Pl. 7. 10). The inscription on one side reads *X*, and *OPE* on the other. As a rule, there are inscriptions on all four sides: 1. The *nummularia* name; 2. the name of the owner or patron for slaves and freedmen; 3. the designation of verification with the day and month, and 4. the consular year. There are also tiles on which the verification and date are absent. There are, moreover, examples of erasure of the original inscription and engraving of a new one.¹⁴⁴

INSCRIPTIONS ON FIBULAE (TAB. 4)

Among the fibulae from Tilurium, the most numerous group consist of *Aucissa* fibulae.¹⁴⁵ These are military fibulae that are well represented at Roman military sites from the final quarter of the 1st century BC through the end of the 1st century AD. Their dating thereby largely overlaps with the dating of Tilurium as a Roman legionary fortress. *Aucissa* fibulae also account for the most numerous group of metallic items with inscriptions in Tilurium. A total of six different inscriptions have been documented on the head plates of 20 fibulae. The inscription reading *Aucissa* appears in the variations *AVCISSA* (tab. 4. 1), or *[AVCI]SSA* (tab. 4. 2) and *VCISSA* (tab. 4. 3; Fig. 5. 1). One fibula from Tilurium features the inscriptions *CARTILIUS* (tab. 4. 4), *CA[RTILIA]* (tab. 4. 5) and *DAGOMATTUS* (tab. 4. 6; Fig. 5. 2). The most common inscription is *Durnacus*, with the variations *DVRNACV*¹⁴⁶ (tab. 4. 7-8), *VRNACV* (tab. 4. 9), *RNACVS* (tab. 4. 10), *DVRNACO* (tab. 4. 11-12), *[D]VRNACVS* (tab. 4. 13; Fig. 5. 3), and *DRNACV[S]* (tab. 4. 14; Fig. 5. 4). With a total of eight *Aucissa* fibulae bearing the inscription *Durnacus*, Tilurium is the site with the highest number of fibulae of this type in Dalmatia, but this is not sufficient to back speculation on their production in Tilurium.¹⁴⁷ *Durnacus* also predominates in inscriptions rendered in two lines (tab. 4. 15-17; Fig. 5. 5-7). Two such inscriptions are entirely illegible (tab. 4. 18-19; Fig. 5. 8).¹⁴⁸ The inscription *Valer* also appears on one fibula, in the variation *PVALE[R]* (tab. 4. 20; Fig. 5. 9).

144 Gostenčnik 2005, pp. 248-261.

145 Marović 1961; Šeparović 2003; Marović 2006; Ivčević 2011; Ivčević 2014; Ivčević 2017.

146 Fibula tab. 8. 7. was published as a find from Podgrađe, but it is registered as being from Tilurium in the old museum inventory log. We would like to thank our colleague Sanja Ivčević for this information.

147 Ivčević 2017, p. 257.

148 Fibula tab. 8. 19. was published as find from an unknown site, but it is registered as being from Tilurium in the old museum inventory log. We would again like to thank our colleague Sanja Ivčević for this information.

145 Marović 1961; Šeparović 2003; Marović 2006; Ivčević 2011; Ivčević 2014; Ivčević 2017.

146 Fibula tab. 8. 7. objavljena je kao nalaz iz Podgrađa, no u staroj muzejskoj inventarnoj knjizi piše da je iz Tilurija. Zahvaljujemo kolegici Sanji Ivčević na navedenim podacima.

	Signatura	Pečat	Datacija	Literatura
1	AMS-H-5115	AVCISSA	1. st. po. Kr.	Marović 2006, str. 83, kat. br. I. 2.
2	AMS-H-5122	[AVCI]SSA	1. st. po. Kr.	Marović 2006, str. 84, kat. br. I. 9.
3	AMS-H-5223	VCISSA	1. st. po. Kr.	Marović 2006, str. 83, kat. br. I. 5.
4	AMS-H-4212	CARTILIVS	1. st. po. Kr.	Marović 2006, str. 85, kat. br. III. 8.
5	AMZ	CA[RTILIA]	1. st. po. Kr.	Marović 2006, str. 86, kat. br. IV. 8.
6	AMS-H-5121	DAGOMATTV	1. st. po. Kr.	Marović 2006, str. 87, kat. br. VI. 2.
7	AMS-H-5292	DVRNACV	1. st. po. Kr.	Marović 2006, str. 87, kat. br. VII. 7.
8	AMS-H-5320	DVRNACV	1. st. po. Kr.	Marović 2006, str. 87, kat. br. VII. 8.
9	AMS-H-5119	VRNACV	1. st. po. Kr.	Marović 2006, str. 87, kat. br. VII. 12.
10	AMS-H-5116	RNACVS	1. st. po. Kr.	Marović 2006, str. 87, kat. br. VII. 13.
11	AMS-H-5293	DVRNACO	1. st. po. Kr.	Marović 2006, str. 88, kat. br. VII. 15.
12	AMS-H-5118	DVRNACO	1. st. po. Kr.	Marović 2006, str. 88, kat. br. VII. 16.
13	GAR 08 PN 212	[D]VRNACVS	1. st. po. Kr.	Ivčević 2017, str. 300, kat. br. 252.
14	GAR 07 PN 11	DRNACV[S]	1. st. po. Kr.	Ivčević 2017, str. 301, kat. br. 253.
15	AMS-H-5117	[---] / DVRNACVS	1. st. po. Kr.	Marović 2006, str. 91, kat. br. XV. 1.
16	AMS-H-5113	[---] / DVRNACVS	1. st. po. Kr.	Marović 2006, str. 91, kat. br. XV. 2.
17	AMS-H-5279	[---] / DVRNACVS	1. st. po. Kr.	Marović 2006, str. 91, kat. br. XV. 3.
18	AMS-H-5114	dva reda, nečitko	1. st. po. Kr.	Marović 2006, str. 91, kat. br. XV. 13.
19	AMS-H-5123	oštećen		Marović 2006, str. 91, kat. br. XIV. 9.
20	AMS-H-5120	PVALE[R]	1. st. po. Kr.	Marović 2006, str. 89, kat. br. XI. 3.

	Signature	Stamp	Dating	Literature
1	AMS-H-5115	AVCISSA	1st c. AD	Marović 2006, p. 83, cat. no. I. 2.
2	AMS-H-5122	[AVCI]SSA	1st c. AD	Marović 2006, p. 84, cat. no. I. 9.
3	AMS-H-5223	VCISSA	1st c. AD	Marović 2006, p. 83, cat. no. I. 5.
4	AMS-H-4212	CARTILIVS	1st c. AD	Marović 2006, p. 85, cat. no. III. 8.
5	AMZ	CA[RTILIA]	1st c. AD	Marović 2006, p. 86, cat. no. IV. 8.
6	AMS-H-5121	DAGOMATTV	1st c. AD	Marović 2006, p. 87, cat. no. VI. 2.
7	AMS-H-5292	DVRNACV	1st c. AD	Marović 2006, p. 87, cat. no. VII. 7.
8	AMS-H-5320	DVRNACV	1st c. AD	Marović 2006, p. 87, cat. no. VII. 8.
9	AMS-H-5119	VRNACV	1st c. AD	Marović 2006, p. 87, cat. no. VII. 12.
10	AMS-H-5116	RNACVS	1st c. AD	Marović 2006, p. 87, cat. no. VII. 13.
11	AMS-H-5293	DVRNACO	1st c. AD	Marović 2006, p. 88, cat. no. VII. 15.
12	AMS-H-5118	DVRNACO	1st c. AD	Marović 2006, p. 88, cat. no. VII. 16.
13	GAR 08 PN 212	[D]VRNACVS	1st c. AD	Ivčević 2017, p. 300, cat. no. 252.
14	GAR 07 PN 11	DRNACV[S]	1st c. AD	Ivčević 2017, p. 301, cat. no. 253.
15	AMS-H-5117	[---] / DVRNACVS	1st c. AD	Marović 2006, p. 91, cat. no. XV. 1.
16	AMS-H-5113	[---] / DVRNACVS	1st c. AD	Marović 2006, p. 91, cat. no. XV. 2.
17	AMS-H-5279	[---] / DVRNACVS	1st c. AD	Marović 2006, p. 91, cat. no. XV. 3.
18	AMS-H-5114	two rows, illegible	1st c. AD	Marović 2006, p. 91, cat. no. XV. 13.
19	AMS-H-5123	damaged		Marović 2006, p. 91, cat. no. XIV. 9.
20	AMS-H-5120	PVALE[R]	1st c. AD	Marović 2006, p. 89, cat. no. XI. 3.

Tablica 4.

Natpisi na Aucissa fibulama iz Tilurija

Table 4.

Inscriptions on Aucissa fibulae from Tilurium

proizvodnji u Tiluriju.¹⁴⁷ *Durnacus* prevladava i na natpisima u dva retka (tab. 4. 15-17; sl. 5. 5-7). Dva takva natpisa u potpunosti su nečitka (tab. 4. 18-19; sl. 5. 8).¹⁴⁸ Natpis Valer također se javlja na jednoj fibuli, i to u varijanti *PVALE[R]* (tab. 4. 20; sl. 5. 9).

NATPISI NA DRUGIM METALNIM PREDMETIMA

Osim *Aucissa* fibula u Tiluriju je dokumentirano i nekoliko drugih metalnih predmeta s natpisima. Dio tih predmeta može se izravno povezati s nazočnošću rimske vojske u Tiluriju, a dio nije nužno vezan uz vojsku i vojnike, ali ta veza nije ni isključena. Uglavnom je riječ o predmetima koji svjedoče o gospodarskom i religioznom životu u Tiluriju. S nazočnošću rimske vojske u Tiluriju izravno se može povezati prethodno već spomenuta olovna plomba s natpisom *LEG XI* (sl. 6). Natpis je otisnut u nepravilnom okviru, a naziru se gornji, donji i lijevi rub, dok na desnom kraju plomba završava brojem *I*. Već je Patsch primijetio da se na poleđini i u presjeku predmeta jasno vide otisci vezice oko koje je predmet bio stisnut.¹⁴⁹ Plomba se temeljem izostanka početnog naslova *Claudia pia fidelis* može datirati u razdoblje prije 42. god. Ona je mogla označavati robu koju je XI. legija isporučivala u Tilurij ili robu koja je u Tiluriju bila predviđena za veksilaciju te legije, čija se nazočnost, kao što smo već istaknuli, pretpostavlja na osnovi drugih spomenika. Ulomak brončane ploče s natpisom na obje strane interpretiran je kao ulomak vojne diplome (sl. 7).¹⁵⁰ Na jednoj strani sačuvani su dijelovi triju redaka natpisa *[---]X[---] / [---]XX[---] / [---] P [---]*, a na drugoj samo dio jednog reda natpisa *[---] / [---]CRI[---] / [---]*. Zbog stanja očuvanosti nažalost ulomak nije moguće pobliže interpretirati i datirati. Među metalnim predmetima ističe se brončani pečat s drškom (sl. 8). Drška ima široku okruglu ušicu, a na vrhu drške nalazi se natpis *SCI*. U pravokutnom polju pečata nalazi se natpis *IVCVNDI* sa slovima *DI* u ligaturi. Pečat se datira u vrijeme od 1. do 2. stoljeća.¹⁵¹ Iz Tilurija potječe i jedan uteg kuglastog oblika sa zaravnjenom gornjom i donjom stranom (sl. 9). Na gornjoj strani urezana je oznaka u obliku slova *V* te kratka vodoravna crta iznad središnjeg udubljenja. Uteg teži ¼ unce, odnosno 6 skripula i datira se u vrijeme od 3. do 6. st.¹⁵² Široka datacija još obuhvaća posljednjih pedeset godina nazočnosti VIII. kohorte *voluntariorum civium Romanorum*, ali većim dijelom pokriva razdoblje kada Tilurij više nije bio rimski vojni logor. Ulomak bron-

INSCRIPTIONS ON OTHER METALLIC ITEMS

Besides *Aucissa* fibulae, several other metallic items bearing inscriptions have been documented in Tilurium. Some of these items may be directly linked to the presence of the Roman army in Tilurium, while some are not necessarily tied to the army and soldiers, although this possibility may not be discounted, either. Generally these are items that testify to economic and religious life in Tilurium. The previously mentioned lead seal with the inscription *LEG XI* (Fig. 6) may be directly linked to the presence of the Roman army in Tilurium. The inscription was impressed inside an irregular frame, and the upper, lower and left edges can be discerned, while on the right edge the seal ends with the number *I*. Patsch already noticed the visible imprints of the bonds on which the item was pressed on its rear side and cross-section.¹⁴⁹ Based on the absence of the honorary title *Claudia pia fidelis*, the seal may be dated to the period prior to 42 AD. It may have designated the goods which Legio XI delivered to Tilurium, or goods in Tilurium there were intended for one of this legion's provisional detachments, whose presence – as already noted – has been assumed on the basis of other artefacts. The fragment of a bronze plate bearing inscriptions on both sides has been interpreted as a piece of a military diploma (Fig. 7).¹⁵⁰ One side has three preserved lines of an inscription *[---]X[---] / [---]XX[---] / [---] P [---]*, while the other side has one line, *[---] / [---]CRI[---] / [---]*. Unfortunately, the fragment cannot be more closely interpreted and dated due to its poor condition. Notable among the metallic items is a bronze stamp with handle (Fig. 8). The handle has a wide round eyehole, and the tip of the handle bears the inscription *SCI*. The inscription *IVCVNDI* with the letters *DI* in ligature is in the stamp's rectangular field. The stamp has been dated to the period from the 1st to 2nd centuries.¹⁵¹ A spherical weight with flattened top and bottom also came from Tilurium (Fig. 9). A V-shaped designation and a horizontal line above the central depression are incised onto the upper side. The weight weighs ¼ ounce, or 6 scripula, and has been dated to the period spanning the 3rd to 6th centuries.¹⁵² The broad dating still encompasses the final fifty years of the presence of Cohors VIII *voluntariorum civium Romanorum*, but in large part it covers the period when Tilurium was no longer a Roman legionary fortress. The fragment of a bronze plate bearing the *OCTAVI(i) OPTATI CAPVA[ni?]* on which the letters *APV* are rendered in ligature has unfortunately not been pre-

147 Ivčević 2017, str. 257.

148 Fibula tab. 8. 19. objavljena je kao nalaz s nepoznatog nalazišta, no u staroj muzejskoj inventarnoj knjizi piše da je iz Tilurija. Zahvaljujemo kolegici Sanji Ivčević na navedenim podacima.

149 Bulić 1893, str. 169 = AMS H-3160; Patsch 1898, col. 121-122; Betz 1939, str. 22, 67, kat. br. 85; CIL III 13350.

150 MCK-B-394. Ilkić 2009, str. 147.

151 Šeparović 2003, str. 226, 247, 256, kat. br. 66, sl. 3.

152 Jovanović 2012, str. 186 i 199, kat. br. 22. = AMS H-4194.

149 Bulić 1893, p. 169 = AMS H-3160; Patsch 1898, col. 121-122; Betz 1939, pp. 22, 67, cat. no. 85; CIL III 13350.

150 MCK-B-394. Ilkić 2009, p. 147.

151 Šeparović 2003, pp. 226, 247, 256, cat. no. 66, fig. 3.

152 Jovanović 2012, pp. 186 and 199, cat. no. 22. = AMS H-4194.



Slika 6.
Olovna plomba s natpisom
LEG XI, Arheološki muzej u
Splitu, inv. br. H-3160 (foto:
T. Seser)

Figure 6.
Lead seal with the inscription
LEG XI, Archaeological
Museum in Split, inv. no.
H-3160 (photo: T. Seser)



Slika 7.
Ulomak vojne diplome, Muzej
Cetinske krajine – Sinj, inv.
br. MCK-B-394 (foto: Arhiva
MCK)

Figure 7.
The fragment of a military
diploma, Cetina Territorial
Museum in Sinj, inv. no.
MCK-B-394 (photo: MCK
Archive)



Slika 8.
Brončani pečat s drškom i
natpisom, Muzej triljskog
kraja, inv. br. MTK-54 (foto: D.
Bavoljak)

Figure 8.
A bronze stamp with handle
and inscription, Trilj Regional
Museum in Trilj, inv. no. MTK-
54 (photo: D. Bavoljak)

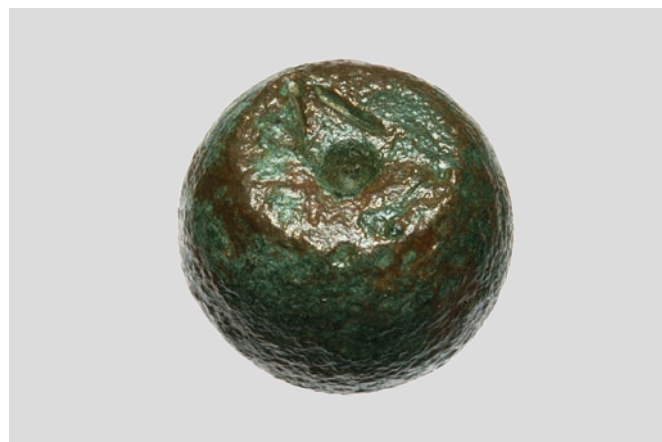

Slika 9.
Uteg s natpisom, Arheološki
muzej u Splitu, inv. br. H-4194
(foto: T. Seser)

Figure 9.
A weight with inscription,
Archaeological Museum in
Split, inv. no. H-4194 (photo:
T. Seser)



Slika 10.
Okrugli žeton od srebrnog
lima s natpisom, Arheološki
muzej u Splitu, inv. br. H-3554
(foto: Z. Podrug)

Figure 10.
A round silver token with
inscription, Archaeological
Museum in Split, inv. no.
H-3554 (photo: Z. Podrug)



Slika 11.
Bakrena pločica s natpisom
zavjetnog karaktera,
Arheološki muzej u Splitu, inv.
br. H-4415 (foto: Z. Podrug)

Figure 11.
Copper plate bearing a
votive inscription character,
Archaeological Museum in
Split, inv. no. H-4415 (photo:
Z. Podrug)

čane pločice s natpisom *OCTAVI(i) OPTATI CAPVA[ni?]* na kojem su slova *APV* izvedena u ligaturi nažalost nije sačuvan i poznat je samo iz starije literature.¹⁵³ Za rimsko vojno nalazište ne bi bilo neobično da je riječ o imenu u genitivu kojim je označeno vlasništvo nad nekim predmetom rimske vojne opreme. No osim što nije sačuvan predmet nažalost nije ni objavljen s crtežom i dimenzijama, pa ni provjera čitanja, interpretacija i datacija nisu mogući. Za okrugli žeton od srebrnog lima, promjera 1,4 cm, na kojem se nalazi natpis *DSB* (sl. 10) ne nalazimo analogije.¹⁵⁴ Pločica od tankog bakrenog lima (sl. 11), od koje je sačuvan ulomak dimenzija 4,3 x 1,8 cm, vjerojatno je bila pričvršćena na predmet zavjetnog karaktera. Natpis u dva retka može se pročitati kao *[lu]LIUS AP[rilis?] / <B=V>OTUM S[olvit]*.¹⁵⁵

Zaključak

Instrumenta inscripta kao zasebna skupina nalaza općenito su važan izvor za razumijevanje rimskih nalazišta, a konkretno i za razumijevanje Tilurija kao rimskoga vojnog uporišta. Većina nalaza iz Tilurija pripada razdoblju prve polovice i sredine 1. st. po. Kr. i time se datira u vrijeme boravka VII. legije, odnosno VII. legije *Claudia pia fidelis*. Pojedini nalazi pak pružaju mogućnost za dataciju rimske nazočnosti u Tiluriju već na kraju 1. st. pr. Kr. To se odnosi na *Aucissa* fibule i na pojedine radioničke pečate na stolnoj keramici italske provenijencije. Pečati XI. legije *Claudiae piae fidelis*, III. legije *Flaviae felix*, III. kohorte *Alpinorum* i

served and is known only from the older scholarly literature.¹⁵³ Given that it was found at a Roman military site, it would not have been unusual if there were a name in the genitive indicating ownership of some piece of military gear. But besides not being preserved, the item was unfortunately never even published with a sketch and dimensions, excluding any possibility of verifying its reading, interpretation and dating. No analogies can be found for a round token made of silver sheeting, with a diameter of 1.4 cm and bearing the inscription *DSB* (Fig. 10).¹⁵⁴ A small plate of thin copper sheeting (Fig. 11), of which a piece with dimensions of 4.3 x 1.8 cm has been preserved, was probably fastened to an item with votive character. The inscription in two lines may be read as *[lu]LIUS AP[rilis?] / <B=V>OTUM S[olvit]*.¹⁵⁵

Conclusion

Instrumenta inscripta as a separate category of finds are generally a vital source for an understanding of Roman sites, and specifically for an understanding of Tilurium as a Roman military stronghold. Most of the finds from Tilurium date to the period from the first half of and mid-1st century AD and the stay of Legio VII and VII *Claudia pia fidelis* and have thereby been dated to this period. Individual finds present the possibility for dating the Roman presence in Tilurium already at the end of the 1st century BC. This pertains to the *Aucissa* fibulae

153 Bulić 1893, str. 169; Bulić 1908, str. 163, br. 5 = AMS H-3181; CIL III 13348.

154 Bulić 1901, str. 141, br. 9 = AMS H-3554

155 Bulić 1908, str. 165, br. 26 = AMS H-4415.

153 Bulić 1893, p. 169; Bulić 1908, p. 163, no. 5 = AMS H-3181; CIL III 13348.

154 Bulić 1901, p. 141, no. 9 = AMS H-3554.

155 Bulić 1908, p. 165, no. 26 = AMS H-4415.

VIII. kohorte *voluntariorum civium Romanorum* na građevinskoj keramici svjedoče o Tiluriju kao rimskom vojnom uporištu i nakon odlaska VII. legije pa sve do sredine 3. stoljeća. Nastavak života u Tiluriju i nakon odlaska posljednje vojne jedinice potvrđuju nalazi utega i grafit na kasnoantičkoj amfori istočnomediteranskog podrijetla. Veliki dio nalaza daje nam uvid u gospodarska kretanja. Pečati na amforama, na sigilati i drugim keramičkim posudama pružaju uvid u proizvodne centre koji su opskrbljivali vojsku u Tiluriju, konkretnije, na intenzivan import proizvoda s italskog područja. Pečati XI. legije *Claudiae piae fidelis* i III. legije *Flaviae felix* na građevinskoj keramici upućuju na isporuke građevinskog materijala ili boravak veksilacija tih legija. Spomenuti nalazi utega, *tessera nummularia* i pečat *IVCUNDI* također su svjedoci gospodarskih aktivnosti. Koštan kocka i žeton odraz su svakodnevnih razonoda, a natpis na metalnoj pločici religioznog života.

and individual workshop stamps on tableware of Italic origin. The stamps of Legio XI *Claudiae piae fidelis* and Legio III *Flaviae felix*, and Cohors III *Alpinorum* and Cohors VIII *voluntariorum civium Romanorum* on ceramic building material testify to Tilurium as a Roman military stronghold even after the departure of Legio VII and until the mid-3rd century. The continuation of life in Tilurium even after the departure of the last military unit is confirmed by the finds of a weight and the graffito on an eastern Mediterranean amphora from Late Antiquity. A major portion of the finds provide insight into the production centres that supplied the army in Tilurium, more specifically, into the intensive imports of products from Italian territory. The stamps of Legio XI *Claudiae piae fidelis* and Legio III *Flaviae felix* on ceramic building material point to the delivery of construction materials or the stay of these legions' provisional detachments. The aforementioned discovery of a weight, *tessera nummularia* and the *IVCUNDI* stamp also testify to economic activity. The bone die and token reflect everyday leisure activities, and the inscription on the metal plate to religious life.

Prijevod / Translation: Apostrof d.o.o.

T. 1



1



2



3



4



5



6



7



8



9



10



11



12



13

T. 2



1

2

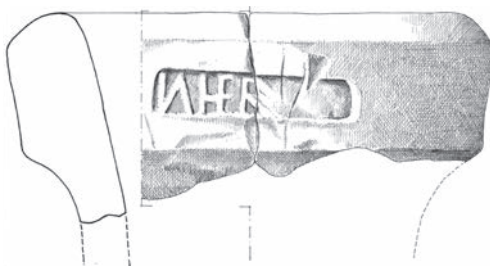

3



4

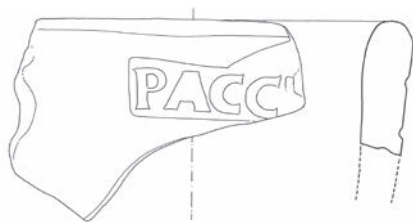

5



6

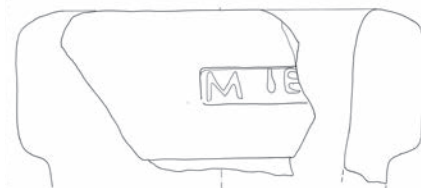

7

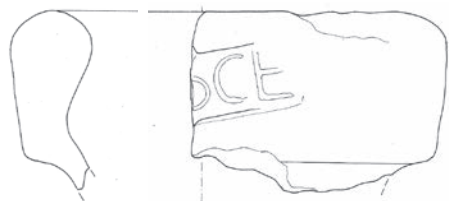

8



9



10



11



12



13



14

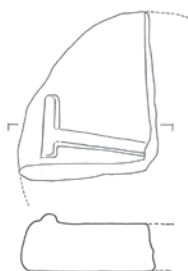

15



16

M 1:1

T. 3

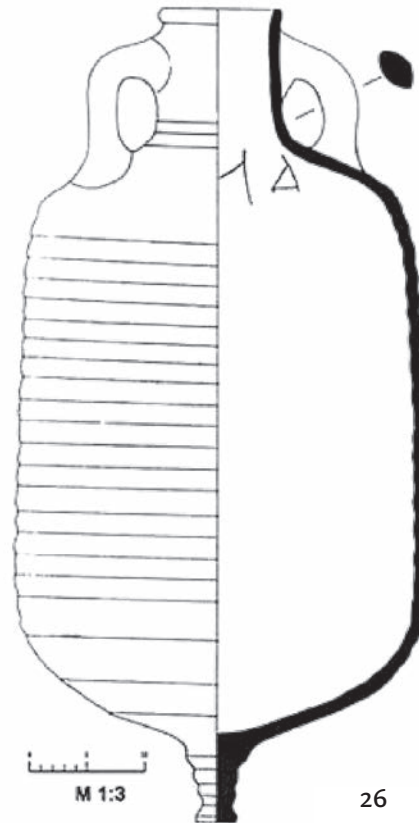
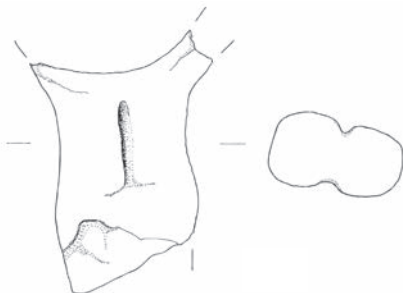
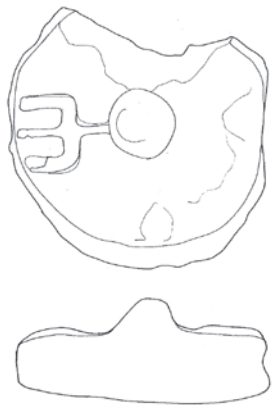
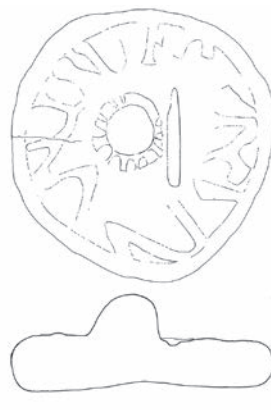
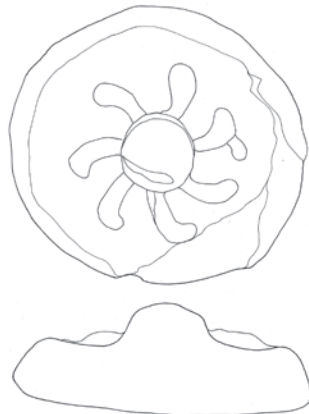
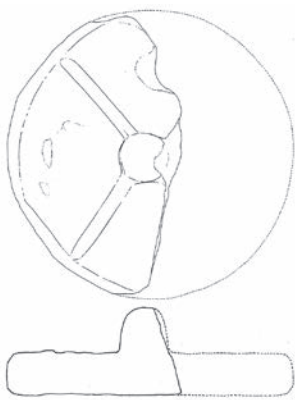

M 1:1

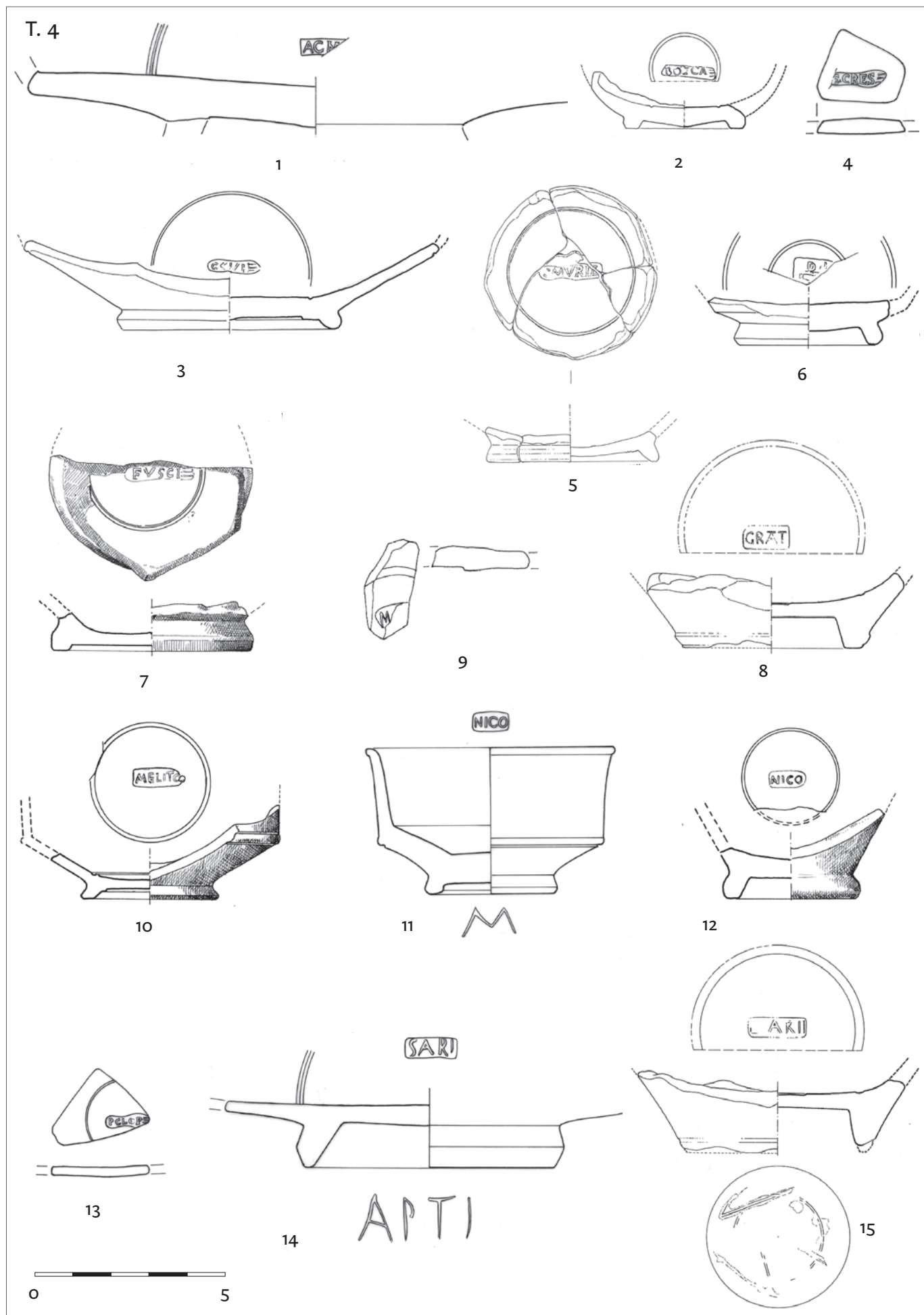

T. 5



16

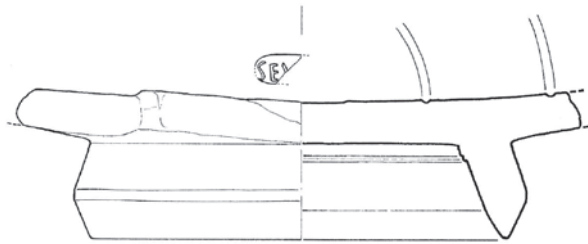

17

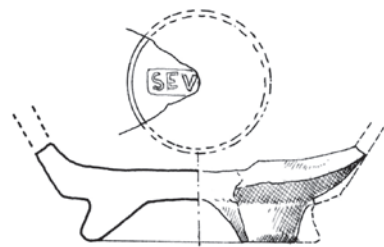

18

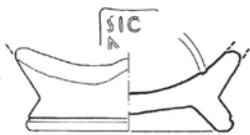

19

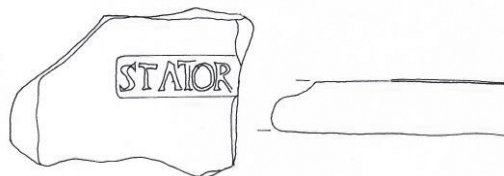

20

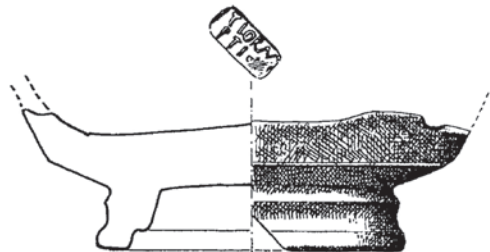

21

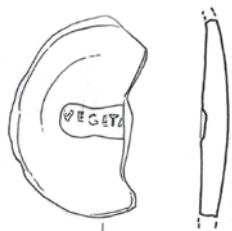

22

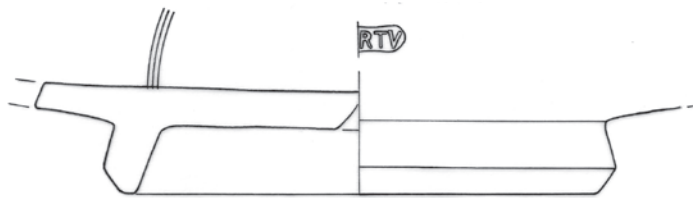

23



24



25

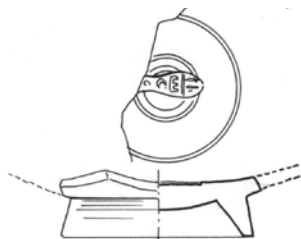

26



27



28

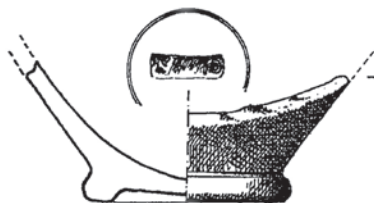

29



30

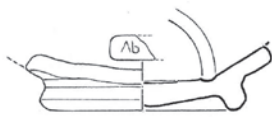

31



32

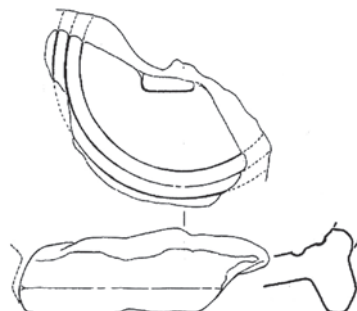

33

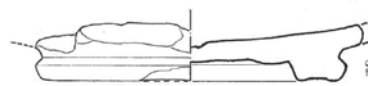

34



T. 6

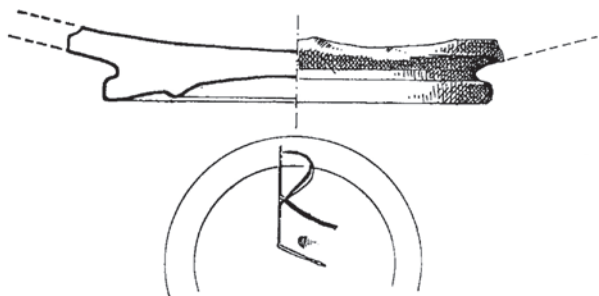

35



36

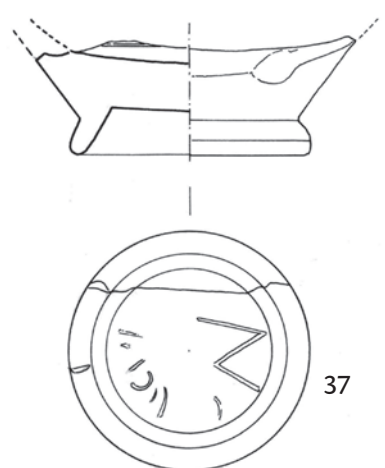

37

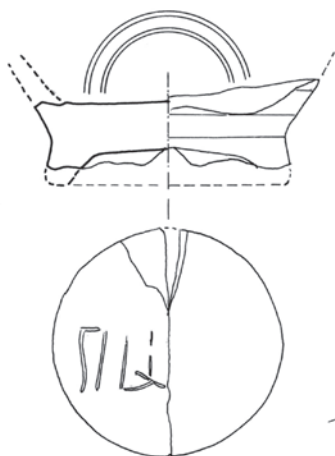

38



39



40

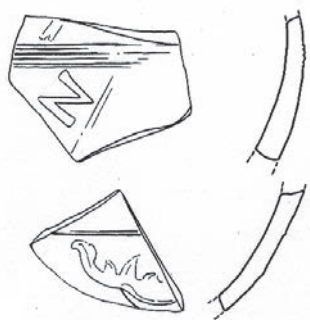

41

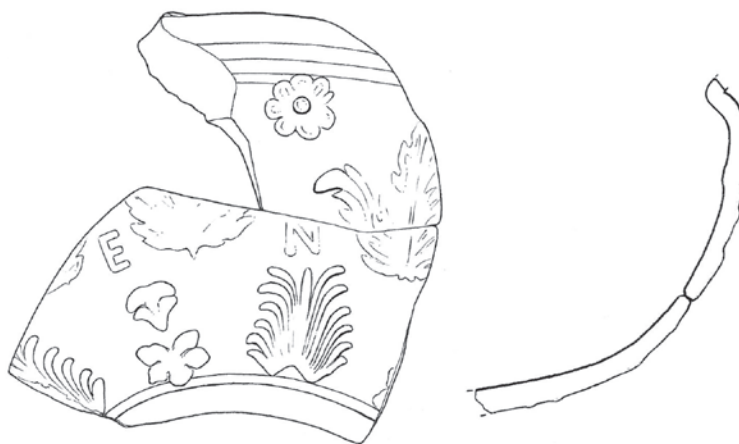

42

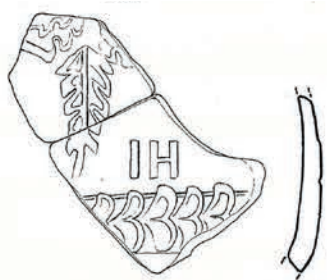

43



T. 7



1

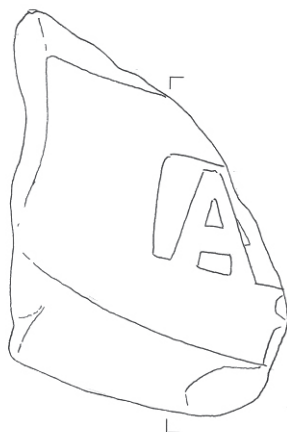

2

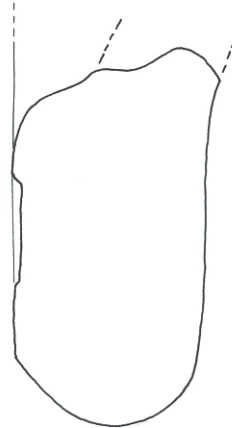

3



4

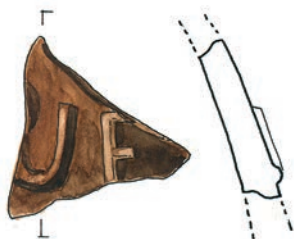
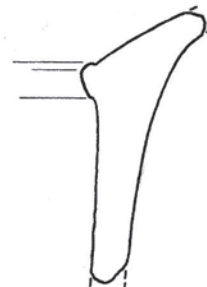

5



6



7

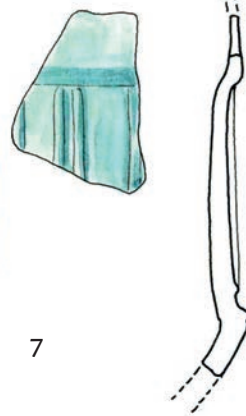

8



9

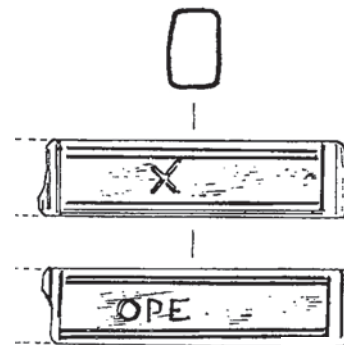
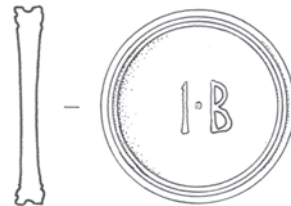

10



Kratice / Abbreviations

CIL III = *Corpus inscriptionum Latinarum*, Berlin.

Conspectus = *Conspectus formarum terrae sigillatae italico modo confectae*, Bonn 2002.

OCK = A. Oxe, H. Comfort, P. Kenrick, *Corpus Vasorum Arretinorum, A Catalogue of the Signatures, Shapes and Chronology of Italian Sigillata*, II. edition, Bonn 2000.

Literatura / Bibliography**Alföldy 1968**

G. Alföldy, *Tilurium*, Pauly's Real-Encyklopädie der classischen Altertumswissenschaft, Supp. XI Stuttgart 1968, kol. 1259-1268.

Alföldy 1987

G. Alföldy, *Die Auxiliärtruppen der Provinz Dalmatien*, in: *Römische Heeresgeschichte: Beiträge 1962–1985*, MAVORS Roman Army Researches, Amsterdam 1987, 239-297.

Babić 2008

A. Babić, *Keramika*, in: M. Topić (ed.), *Arheološka zbirka Franjevačkog samostana u Sinju*, Sinj 2008, 187-227.

Bekić 1998

L. Bekić, *Tri manje privatne zbirke s Garduna*, *Opuscula archaeologica* 22, Zagreb 1998, 233-242.

Betz 1939

A. Betz, *Untersuchungen zur Militärgeschichte der römischen Provinz Dalmatien*, *Abhandlungen des archäologisch-epigraphischen Seminars der Universität Wien*, N. F. 3, Wien 1939.

Bezeczky 1994

T. Bezeczky, *Amphorenfunde vom Magdalensberg und aus Pannonien*, *Archäologische Forschungen zu den Grabungen auf dem Magdalensberg 12*, *Kärntner Museumsschriften* 74, Klagenfurt 1994.

Bezeczky 1998

T. Bezeczky, *Amphora types of Magdalensberg*, *Arheološki vestnik* 49, Ljubljana 1998, 225-242.

Bezeczky 2013

T. Bezeczky, *Early Roman food import in Ephesus: amphorae from the Tetragonos Agora*, in: J. Eiring, J. Lund (eds.), *Transport Amphorae and Trade in the Eastern Mediterranean*, *Acts of the International Colloquium at the Danish Institute at Athens, September 26-29, 2002*, Athens 2004, 85-97.

Bojanovski 1988

I. Bojanovski, *Bosna i Hercegovina u antičko doba*, *Djela LXVI*, Centar za balkanološka ispitivanja 6, Sarajevo 1988.

Borzić 2011

I. Borzić, *Sarius šalice iz Burnuma*, in: G. Lipovac Vrkljan, I. Radić Rossi, B. Šiljeg (eds.), *Rimske keramičarske i staklarske radionice, Proizvodnja i trgovina na jadranskom prostoru*, *Crikvenica* 2011, 279-290.

Borzić 2013

I. Borzić, *Radionički pečati na italskoj tera sigilati iz Burnuma*, *Archaeologia Adriatica* 7, Zadar 2013, 133-150.

Borzić 2020

I. Borzić, *Keramički nalazi iz legijskog logora Burnum*, Šibenik-Puljane 2020.

Borzić et al. 2013

I. Borzić, M. Čelhar, K. Gusar, M. Ilkić, M. Radović, D. Vujević, *Arheološka istraživanja okoliša crkve Sv. Križa u Ninu*, Zadar 2013.

Buchi 1975

E. Buchi, *Lucerne del Museo di Aquileia 1*, in: *Lucerne Romane*

con Marchio di Fabbrica, *Pubblicazioni Dell'Associazione Nazionale per Aquileia*, Aquileia 1975.

Bulić 1887

F. Bulić, *Le Gemme del Museo di Spalato*, *Bullettino di archeologia e storia dalmata* 10, Spalato 1887, 76-78.

Bulić 1889

F. Bulić, *Le Gemme del Museo di Spalato*, *Bullettino di archeologia e storia dalmata* 12, Spalato 1889, 117-118.

Bulić 1891

F. Bulić, *Nomi e marche di fabbrica su tegoli, embrici, mattoni ed altri oggetti fittilini*, *i. r. Museo in Spalato*, *Bullettino di archeologia e storia dalmata* 14, Spalato 1891, 116-117.

Bulić 1893

F. Bulić, *Inscrizioni su oggetti di metallo acquistati dall' i. r. Museo di Spalato negli anni 1892*, *Bullettino di archeologia e storia dalmata* 16, Spalato 1893, 168-169.

Bulić 1894

F. Bulić, *Iscrizioni inedite. Gardun (Arduba?)*, *Bullettino di archeologia e storia dalmata* 17, Spalato 1894, 3-5.

Bulić 1895

F. Bulić, *Nomi e marche di fabbrica su li tegoli e vasi acquistati dall' i. r. Museo in Spalato durante l' a. 1894*, *Bullettino di archeologia e storia dalmata* 18, Spalato 1895, 38.

Bulić 1896

F. Bulić, *Nomi e marche di fabbrica su tegoli acquistati dall' i. r. Museo in Spalato*

durante l' a 1896, *Bullettino di archeologia e storia dalmata* 19, Spalato 1896, 150-151.

Bulić 1901

F. Bulić, *Iscrizioni e rappresentazioni su oggetti di metallo acquistati dall' i. r. Museo di Spalato negli anni 1895-1901*, *Bullettino di archeologia e storia dalmata* 24, Spalato 1901, 139-141.

Bulić 1908

F. Bulić 1908, *Bolli su vasi acquistati dall' i. r. Museo di Spalato negli anni 1901 – 1907 incl.*, *Bullettino di archeologia e storia dalmata* 31, Spalato 1908, 127-128.

Buljević 2012

Z. Buljević, *Tragovi Eniona i Aristeje u rimskoj provinciji Dalmaciji = Traces of Ennion and Aristeas in the Roman province of Dalmatia*, in: *Tragovi Eniona i Aristeje u rimskoj provinciji Dalmaciji = Traces of Ennion and Aristeas in the Roman Province of Dalmatia*, *Exh cat. Split*, Split 2012, 3-19.

Buljević 2014

Z. Buljević, *Stakleni inventar*, in: M. Sanader et al., *Tilurium IV. Arheološka istraživanja* 2007. – 2010. godine, Zagreb 2017, 175-238.

Buljević 2020

Z. Buljević, *Ulomak Enionove šalice iz Siscije*, in: J. Balen (ed.), *Arheološka istraživanja u Sisačko-moslavačkoj županiji*, Sisak 2020, 44.

Cambi et al. 2007

N. Cambi, M. Glavičić, D. Maršić, Ž. Miletić, J. Zaninović, A. Campedelli,

Rimska vojska u Burnumu = L' esercito romano a Burnum, Dрниš-Šibenik-Zadar 2007.

Cesarik 2020

N. Cesarik, *Rimska vojska u provinciji Dalmaciji od Augustova do Hadrijanova principata*, neobjavljena doktorska disertacija, Sveučilište u Zadru, Zadar 2020.

Cipriano 2016

S. Cipriano, *Anfore Lamboglia 2, Dressel 6A e Dressel 6B dal Piazzale della Cattedrale di Iulia Concordia: nuovi dati*, in: M. Buora, S. Magnani (eds.), *Le iscrizioni con funzione didascalico-esplicativa. Committente, destinatario, contenuto e descrizione dell'oggetto nell'instrumentum inscriptum. Atti del VI Incontro Instrumenta inscripta, Aquileia*, marzo 2015., Trieste 2016, 145-158.

Cipriano, Mazzocchin 2000

S. Cipriano, S. Mazzocchin, *Alcune considerazioni su anfore Dressel 6B bollate: i casi di VARI PACCI e PACCI, APICI e APIC, P. Q. SCAPVLAE, P. SEPVLLI P. F e SEPVLLIVM*, *Aquileia Nostra LXIII, Aquileia* 2000, 149-192.

Cipriano, Mazzocchin 2019

S. Cipriano, S. Mazzocchin, *Dressel 6B and Dressel 6A's oil and wine production in North Italy and the Adriatic western coast (1st century BC - 2nd century AD)*, in: J. Remesal Rodríguez, V. Revilla Calvo, D. J. Martín-Arroyo Sánchez, A. M. i Oliveras (eds.), *Paisajes Productivos y Redes de Comerciales en el Imperio Romano*, *Instrumenta* 65, Barcelona 2019, 233-246.

Clairmont, Auth, von Gonzenbach 1975

C.W. Clairmont, S.H. Auth, V. von Gonzenbach, *Excavation in Salona, Yugoslavia (1969-1972)*, New Jersey 1975.

Čerina 2011

D. Čerina, *Osam amfora iz arheološke zbirke Muzeja Cetinske krajine*, in: A. Librenjak, D. Tončinić (eds.), *Arheološka istraživanja u Cetinskoj krajini*, Sinj, 10.-13. listopada, Izdanja Hrvatskog arheološkog društva 27, Zagreb 2011, 219-227.

Fadić 1997

I. Fadić, *Spomenici VII. legije na području Tilurija (Tilurium)*, *Diadora* 18-19, Zadar 1997, 77-119.

Fellmann 2000

R. Fellmann, *Die 11. legion Claudia Pia Fidelis*, in: Y. Le Bohec, C. Wolff (eds.), *Les légions de Rome sous le Haut-Empire*, Lyon 2000, 127-131.

Gavrielatos 2012

A. Gavrielatos, *Names on Gallo-Roman terra sigillata (1st-3rd C. A.D.)*, Ph.D. thesis, University of Leeds, Leeds 2012.

Genin 2000

M. Genin, *Catalogue des marques en contexte et hors contexte*, in: M. Genin (ed.), *La Graufesenque (Millau, Aveyron) Vol. II, Sigillées lisses et autres productions*, Paris 2000, 166-268.

Glavaš 2016

I. Glavaš, *Konzularni beneficijari u rimskoj provinciji Dalmaciji*, Zagreb 2016.

Von Gonzenbach 1975

V. von Gonzenbach, *Pottery from Closed Deposits, Excavation in Salona, Yugoslavia (1969-1972)*, New Jersey 1975, 181-208.

Gostenčnik 2005

K. Gostenčnik, *Die Beinfunde vom Magdalensberg*, Klagenfurt 2005.

Grisonic, Stepan 2017

M. Grisonic, N. Stepan, *Italska terra sigillata iz rimske vile rustike u uvali Caska na otoku Pagu*, *Archaeologia Adriatica* 11, Zadar 2017, 69-143.

Hoey Middleton 1991

S. Hoey Middleton, *Engraved gems from Dalmatia. From the collections of Sir John Gardner Wilkinson and Sir Arthur Evans in Harrow School, at Oxford and elsewhere*, Oxford 1991.

Ilkić 2009

M. Ilkić, *Rimska vojna diploma iz Sotina (Cornacum)*, Prilozi Instituta za arheologiju u Zagrebu 26, Zagreb 2009, 143-164.

Ivčević 2011

S. Ivčević, *Antičke fibule iz vojnog logora Tilurij (Gardun)*, in: A. Librenjak, D. Tončinić (eds.), *Arheološka istraživanja u Cetinskoj krajini*, Izdanja Hrvatskog arheološkog društva 27, Zagreb 2011, 161-185.

Ivčević 2014

S. Ivčević, *Metalni nalazi*, in: M. Sanader et al., *Tilurium III. Istraživanja* 2001. – 2006. godine, Zagreb 2014, 147-223.

Ivčević 2017

S. Ivčević, *Metalni nalazi*, in: M. Sanader et al., *Tilurium IV.*

Arheološka istraživanja 2007. – 2010. godine, Zagreb 2017, 239-358.

Jovanović 2012

J. Jovanović, *Kasnoantički i ranobizantski trgovački brončani utezi kuglastog oblika iz Arheološkog muzeja u Splitu*, *Vjesnik za arheologiju i povijest dalmatinsku* 105, Split 2012, 179-200.

Juras, Jurković Pešić 2016

I. Juras, F. Jurković Pešić, *Tegule s pečatom iz Antičke zbirke Arheološkoga muzeja Zadar*, *Diadora* 30, Zadar 2016, 31-75.

Kaić 2010

I. Kaić, *Četiri intaglia s Garduna u Muzeju Cetinske krajine*, *Opuscula Archaeologica* 34, Zagreb 2010, 115-126.

Kaić 2013

I. Kaić, *Rimski svijet u malome. Geme kao svjedočanstva svakodnevnog života*, doktorska disertacija (rukopis), Sveučilište u Zagrebu, Zagreb 2013.

Kaić 2014

I. Kaić, *Several unpublished engraved gems from Gardun (Tilurium)*, *Nova antička Duklja* 5, Podgorica 2014, 69-78.

Kaić 2017

I. Kaić, *Roman intaglios with inscriptions from the Archaeological Museum in Zagreb*, in: D. Demicheli (ed.), *Ilyrica antiqua 2 – in honorem Duje Rendić Miočević. Proceedings of the international conference, Šibenik, 12th-15th September* 2013, Zagreb 2017, 479-486.

Kaić 2018

I. Kaić, *Engraved gems from Tilurium as a glimpse into the Roman soldiers' sexuality*, in: C. S. Sommer, S. Matešić (eds.), *Limes XXIII. Proceedings of the 23rd International Congress of Roman Frontier Studies Ingolstadt* 2015, Mainz 2018, 1046-1050.

Konestra 2015

A. Konestra, *Italska terra sigillata i keramika tankih stijenki na području sjeverne Liburnije: tipologija, kronologija i distribucija*, doktorska disertacija (rukopis), Sveučilište u Zadru, Zadar 2015.

Kos 1998

P. Kos, *Leksikon antičke numizmatike*, Zagreb 1998.

Maier-Maidl 1992

V. Maier-Maidl, *Stempel und Inschriften auf Amphoren vom Magdalensberg*, *Klagenfurt* 1992.

Makjanić 1985

R. Makjanić, *Terra sigillata iz nekropole u Osoru i Bakru*, *Prinosi Odjela za arheologiju* 1, Zagreb 1985, 39-61.

Marić 2017

A. Marić, *Evidentirani augzilijari cohors III Alpiorum equitata na Humcu*, *Glasnik Zemaljskog muzeja Bosne i Hercegovine u Sarajevu* (A), NS 54 (2012.), Sarajevo 2017, 93-108.

Marović 1961

I. Marović, *Fibeln mit Inschrift vom Typus Avcissa in den archäologischen Museen von Zagreb, Zadar und Split*, *Jahrbuch des Römisch-Deutschen*

Zentralmuseums Mainz 8, Mainz 1961, 106-120.

Marović 2006

I. Marović, *Aucissa fibule s natpisom u arheološkim muzejima u Zagrebu, Zadru i Splitu*, *Vjesnik za arheologiju i povijest dalmatinsku* 99, Split 2006, 81-98.

Martinov 2017

M. Martinov, *Terra sigillata s prostora nekropole u Ulici fra Ivana Zadrana u Zadru*, diplomski rad, Sveučilište u Zadru, Zadar 2017.

Matijević 2009

I. Matijević, *Cohors VIII Voluntariorum civium Romanorum i neki njezini pripadnici u službi namjesnika provincije Dalmacije*, *Tusculum* 2, Solin 2009, 45-58.

Matijević 2013

I. Matijević, *Nova epigrafska potvrda vojnika VIII dobrovoljačke kohorte u Saloni*, *Tusculum* 6, Solin 2013, 117-124.

Matijević, Šimić-Kanaet 2020

V. Matijević, Z. Šimić-Kanaet, *Shedding light on the Roman oil lamps from Tilurium*, in: S. Traxler, F. Lang (eds.), *Colloquium Lauriacum* 2016. *Das römische Heer – Wirtschaftsfaktor und Kulturträger. Beiträge zur Tagung im Museum Lauriacum – Enns, 22.-24. September* 2016, Linz 2020, 97-103.

Mazzocchin 2009

S. Mazzocchin, *Le anfore con collo ad imbuto: nuovi dati e prospettive di ricerca*, in: S. Pesavento Mattioli, M.B. Carre (eds.), *Olio e pesce in*

epoca romana. Produzione e commercio nelle regioni dell'alto adriatico, Roma 2009, 191-213.

Mazzocchin 2011

S. Mazzocchin, *Traffici commerciali a Vicenza in epoca romana: i dati delle anfore*, Ph.D. thesis, University of Padova, Padova 2011.

Menchelli, Ciuccarelli 2009

S. Menchelli, M.R. Ciuccarelli, *I depositi di anfore lungo il litorale fermano: nuovi dati per la produzione ed il commercio del vino piceno*, *The Journal of Fasti online* (www.fastionline.org/docs/FOLDER-it-2009-132.pdf).

Miletić 2011

Ž. Miletić, *Production of tegulae in Burnum in the context of building activities*, in: G. Lipovac Vrkljan, I. Radić Rossi, B. Šiljeg (eds.), *Rimske keramičarske i staklarske radionice. Proizvodnja i trgovina na jadranskom prostoru*, *Zbornik I. međunarodnog arheološkog kolokvija, Crikvenica*, 23. – 24. listopada 2008, Crikvenica 2011, 263-277.

Mongardi 2018

M. Mongardi, *Firmissima et splendidissima populi romani colonia. L'epigrafia anforica di Mutina e del suo territorio*, Barcelona 2018.

Nardelli 2011

B. Nardelli, *Gemme antiche dalla Dalmazia. Intagli e cammei da Tilurium*, Izola 2011.

Nesselhauf 1941

H. Nesselhauf, *Die Legionen Moesiens unter Claudius und Nero*, *Laurae Aquincenses* 2, Budapest 1941, 40-46.

Ožanić 2005

I. Ožanić, *Tipovi amfora iz Cibala*, Vjesnik za arheologiju i povijest dalmatinsku 98, Split 2005, 133-149.

Patsch 1898

C. Patsch, *Piomho der legio XI Claudia p. f. aus Gardun*, Jahreshefte des Österreichischen archäologischen Instituts in Wien 1, Beiblat, Wien 1898, 121-124.

Patsch 1900

C. Patsch, *Archäologisch-epigraphische Untersuchungen zur Geschichte der römischen Provinz Dalmatien. Vierter Teil*, Wiss. Mitt. Bosnien u. Herzegovina 7, Wien 1900, 33-166.

Patsch 1907

C. Patsch, *Zur Geschichte und Topographie von Narona*, Schriften der Balkankommission 5, Vienna 1907.

Patsch 1914

C. Patsch, *Zbirke rimskih i grčkih starina u bos.-herc. zemaljskom muzeju*, Glasnik Zemaljskog muzeja u Bosni i Hercegovini 26, Sarajevo 1914, 141-220.

Patsch 1915

C. Patsch, *Zbirka grčkih i rimskih starina u bos.-herc. Zemaljskome muzeju*, Sarajevo 1915.

Pedišić, Podrug 2007

I. Pedišić, E. Podrug, *Antički opekarški pečati iz fundusa Muzeja grada Šibenika*, Opuscula Archaeologica 31, Zagreb 2007, 81-142.

Pretnjača 2011

I. Prtenjača, *Lončarski pečati s lokaliteta Sveti Ivan i Kod "Zdravljaka" u Zadru*, Diadora 25, Zadar 2011, 55-74.

Ritterling 1925

E. Ritterling, *Legio*, Paulys Real-Encyklopädie der classischen Altertumswissenschaft 12, Stuttgart 1925, kol. 1211-1829.

Sanader 1998

M. Sanader, *Tilurij – rimski vojni logor. Prethodni izvještaj s istraživanja 1997 i 1998*, Opuscula Archaeologica 22, Zagreb 1998, 243-255.

Sanader 1999

M. Sanader, *Arheološka istraživanja u Gardunu*, Obavijesti HAD-a 3, Zagreb 1999, 75-85.

Sanader 2000

M. Sanader, *Tilurij – rimski vojni logor. Preliminarno izvješće 1999*, Obavijesti HAD-a XXXII/1, Zagreb 2000, 51-62.

Sanader 2001

M. Sanader, *Tilurij – rimski vojni logor. Prethodno izvješće s arheoloških istraživanja u sezoni 2000*, Opuscula Archaeologica 25, Zagreb 2001, 183-194.

Sanader 2002a

M. Sanader, *Tilurij – arheološka istraživanja u godini 2002*, Obavijesti HAD-a XXXIV/3, Zagreb 2002, 87-97.

Sanader 2002b

M. Sanader, *Tilurium, Burnum and Bigeste. A New Contribution to the Dating of the Delmataen Limes*, in:

Freeman et al. (eds.), *Limes XVIII = Proceedings of the XVIIIth International Congress of Roman Frontier Studies Held in Amman, Jordan (September 2000)*, BAR Internat. Ser. 1084 (II), Oxford 2002, 713-718.

Sanader 2002c

M. Sanader, *Tilurium, Burnum, Bigeste. Novi prilog dataciji delmatskog limesa*, in: *Arheološke studije i ogledi*, Zagreb 2002, 120-128.

Sanader 2003

M. Sanader, *Tilurium I. Istraživanja = Forschungen 1997. – 2001.*, Zagreb 2003.

Sanader, Tončinić 2003

M. Sanader, D. Tončinić, *Tilurij – arheološka istraživanja u godini 2003*, Obavijesti HAD-a XXXV/3, Zagreb 2003, 87-94.

Sanader, Tončinić 2010

M. Sanader, D. Tončinić, *Gardun - antički TILURIUM = Gardun - The ancient TILURIUM*, in: I. Radman-Livaja (ed.), *Nalazi rimske vojne opreme u Hrvatskoj = Finds of the Roman Military Equipment in Croatia*, Zagreb 2010, 33-53.

Sanader, Tončinić 2013

M. Sanader, D. Tončinić, *Das Projekt Tilurium*, in: M. Sanader, A. Rendić-Miočević, D. Tončinić, I. Radman-Livaja (eds.), *Rimska vojna oprema u pogrebnom kontekstu, Radovi XVII. ROMEC-a = Weapons and Military Equipment in a Funerary Context. Proceedings of the XVIIth ROMEC*, Zagreb 2010, Zagreb 2013, 411-433.

Sanader et al. 2005

M. Sanader, D. Tončinić, I.

Ožanić, I. Miloglav, *Tilurij – arheološka istraživanja 2004*, Opuscula archaeologica 28, Zagreb 2005, 221-245.

Sanader et al. 2013

M. Sanader, D. Demicheli, M. Miličević Bradač, A. „poet“ in the military camp at Tilurium, in: M. Sanader, A. Rendić-Miočević, D. Tončinić, I. Radman-Livaja (eds.), *Rimska vojna oprema u pogrebnom kontekstu, Radovi XVII. ROMEC-a = Weapons and Military Equipment in a Funerary Context. Proceedings of the XVIIth ROMEC*, Zagreb 2010, Zagreb 2013, 483-491.

Sanader et al. 2014

M. Sanader, D. Tončinić, Z. Buljević, S. Ivčević, T. Šeparović, *Tilurium III. Istraživanja 2002. – 2006. godine*, Zagreb 2014.

Sanader et al. 2017

M. Sanader, D. Tončinić, Z. Šimić-Kanaet, Z. Buljević, S. Ivčević, T. Šeparović, I. Miloglav, *Tilurium IV. Istraživanja 2007. – 2010. godine*, Zagreb 2017.

Sanader et al. 2019

M. Sanader, M. Vukov, D. Bužanić, *Pax Romana između Burna i Tilurija. Krajolik sukoba*, Prilozi Instituta za arheologiju u Zagrebu 36, Zagreb 2019, 121-134.

Schallmayer et al. 1990

E. Schallmayer, K. Eibl, J. Ott, G. Preuss, E. Wittkopf, *Der römische Weihebezirk von Osterburken I: Corpus der griechischen und lateinischen Beneficiärer-Inschriften des Römischen Reiches*, Stuttgart 1990.

Sinobad 2009

M. Sinobad, *Burnum, rimska vojska i Jupiterov kult*, Godišnjak Titius 2, Split 2009, 9-26.

Spaul 2000

J. E. H. Spaul, *Cohors2*, BAR Internat. Ser. 841, Oxford 2000.

Starac 1994

A. Starac, *Rimske svjetiljke iz nekropole na Marsovom polju u Puli*, *Histria Archaeologica* 22-23, Pula 1994, 5-43.

Starac 2001

A. Starac, *Produzione e distribuzione delle anfore nord-adriatiche nell'Istria, Rei Cretariae Romanae Favtorum Acta 37*, Abington 2001, 269-277.

Starac 2008

A. Starac, *A deposit of roman amphorae in Pula (Croatia): A Preliminary report, Rei Cretariae Romanae Favtorum Acta 40*, Bonn 2008, 121-131.

Strobel 2000

K. Strobel, *Zur Geschichte der Legionen V (Macedonica) und VII (Claudia pia fidelis) under früschen Kaiserzeit und zurstellung der provinz Gallatia in der augusteichen Heeregeschichte*, in: Y. Le Bohec, C. Wolff (eds.), *Les légions de Rome sous le Haut-Empire*, Lyon 2000, 515-528.

Šašel 1974

J. Šašel, *Die Limes-Entwicklung in Illyricum*, in: D.M. Pippidi (ed.), *D'études Sur Les Frontieres Romaines: Actes Du IXe Congres International, Mamaia, 6-13 Septembre 1972*, Bucuresti – Köln 1974, 194-199.

Šašel 1992

J. Šašel, *Die Limes-Entwicklung in Illyricum*, in: *Opera Selecta*, Ljubljana 1992, 397-403.

Šašel Kos 1997

M. Šašel Kos, *Dalmatae, Dalmatia*, *Der Neue Pauly. Enzyklopädie der Antike*, sv. 3, Stuttgart – Weimar 1997, 282-286.

Šašel Kos 2005

M. Šašel Kos, *Appian and Illyricum*, Ljubljana 2005.

Šeparović 2003

T. Šeparović, *Metalni nalazi = Metallfunde*, in: M. Sanader, *Tilurium I. Istraživanja = Forschungen* 1997. – 2001., Zagreb 2003, 219-259.

Šimić-Kanaet 2003a

Z. Šimić-Kanaet, *Keramika = Keramik*, in: M. Sanader, *Tilurium I. Istraživanja = Forschungen* 1997. – 2001., Zagreb 2003, 109-188.

Šimić-Kanaet 2003b

Z. Šimić-Kanaet, *Lončarski pečati na rimskoj keramici s Garduna*, *Opuscula archaeologica* 27, Zagreb 2003, 455-462.

Šimić-Kanaet 2004

Z. Šimić-Kanaet, *Sarius šalica iz Garduna*, *Opuscula archaeologica* 28, Zagreb 2004, 187-191.

Šimić-Kanaet 2010

Z. Šimić-Kanaet, *Tilurium II. Keramika* 1997. – 2006., Zagreb 2010.

Šimić-Kanaet 2011

Z. Šimić-Kanaet, *Rimske svjetiljke iz Tilurija*, in: A. Librenjak, D. Tončinić (eds.), *Arheološka istraživanja u*

Cetinskoj krajini, Sinj, 10.-13. listopada 2006., Izdanja Hrvatskog arheološkog društva 27, Zagreb – Sinj 2011, 187-218.

Šimić-Kanaet 2017

Z. Šimić-Kanaet, *Keramički nalazi*, in: M. Sanader et al., *Tilurium IV. Arheološka istraživanja* 2007. – 2010. godine, Zagreb 2017, 77-173.

Šimić-Kanaet 2021

Z. Šimić-Kanaet, *Keramički nalazi*, in: M. Sanader et al., *Tilurium V. Arheološka istraživanja* 2010. – 2018. godine, Zagreb 2021.

Šimić-Kanaet, Zaninović 2007

Z. Šimić-Kanaet, J. Zaninović, *Lončarski pečati na rimskoj keramici iz Burnuma i Tilurija*, in: D. Marguš (ed.), *Simpozij Rijeka Krka i Nacionalni park "Krka": prirodna i kulturna baština, zaštita i održivi razvitak: zbornik radova, Šibenik*, 5.-8. listopada 2005, Šibenik 2007, 229-244.

Tončinić 2003

D. Tončinić, *Koštani i drugi nalazi = Knochen und andere Funde*, in: M. Sanader, *Tilurium I. Istraživanja = Forschungen* 1997. – 2001., Zagreb 2003, 257-270.

Tončinić 2007

D. Tončinić, *Werkzeugdarstellungen auf einer Grab-stele aus Tilurium*, in: E. Walde, B. Kainrath (eds.), *Die Selbstdarstellung der römischen Gesellschaft in den Provinzen im Spiegel der Steindenkmäler. Akten des IX. Internationalen Kolloquiums über Probleme des Provinzialrömischen*

Kunstschaffens, Innsbruck 2007, 259-264.

Tončinić 2009

D. Tončinić, *Ziegelstempel römischer Militäreinheiten in der Provinz Dalmatien*, in: A. Morillo, N. Hanel, E. Martin (eds.), *LIMES XX. Estudios sobre la frontera romana/ Roman Frontier Studies*, Madrid 2009, 1447-1459.

Tončinić 2011

D. Tončinić, *Spomenici VII. legije na području rimske provincije Dalmacije*, Split 2011.

Tončinić 2020

D. Tončinić, *Das Wirtschaftspotential der römischen Legionäre II. Inschriften der Legio VII im Legionslager Tilurium und Dalmatien*, in: S. Traxler, F. Lang (eds.), *Colloquium Lauriacum 2016. Das römische Heer – Wirtschaftsfaktor und Kulturträger. Beiträge zur Tagung im Museum Lauriacum – Enns*, 22.-24. September 2016, Linz 2020, 191-204.

Tončinić et al. 2011

D. Tončinić, A. Tabak, A. Librenjak, *Rimski vojni pečati u Cetinskoj krajini*, in: A. Librenjak, D. Tončinić (eds.), *Arheološka istraživanja u Cetinskoj krajini, Sinj*, 10.-13. listopada 2006., Izdanja Hrvatskog arheološkog društva 27, Zagreb – Sinj 2011, 361-379.

Topić 2005

M. Topić, *Keramika iz Augusteuma Narone*, Vjesnik za arheologiju i historiju dalmatinsku 97, Split 2005, 69-93.

Veith 1914

G. Veith, *Die Feldzüge des C. Julius Caesar Octavianus in Illyrien 35-33 v. Chr.*, Schriften der Balkankommission, Antiquarische Abteilung, vol. VII, Wien 1914.

Vrbanc 2012

P. Vrbanc, *Cohors VIII voluntariorum civium Romanorum na području rimske provincije Dalmacije*, diplomski rad, Sveučilište u Zagrebu, Zagreb 2012.

Vukov 2018

M. Vukov, *Altars Set Up by Roman Soldiers at Military Sites on the Danubian and Delmataean Limes in Croatia*, in: C. S. Sommer, S. Matešić (eds.), *Limes XXIII. Proceedings of the 23rd International Congress of Roman Frontier Studies Ingolstadt 2015*, Mainz 2018, 968-973.

Vukov 2020

M. Vukov, *Amphorae and Food supply at Roman military sites in Croatia*, in: S. Traxler, F. Lang (eds.), *Colloquium Lauriacum 2016. Das römische Heer – Wirtschaftsfaktor und Kulturträger. Beiträge zur Tagung im Museum Lauriacum – Enns, 22.-24. September 2016*, Linz 2020, 229-239.

Wilkes 1969

J. J. Wilkes, *Dalmatia*, London 1969.

Wilkes 1977

J. J. Wilkes, *Augustan Limes in Illyricum?*, in: D. Haupt & H. G. Horn (ed.), *Studien zu den Militärgrenzen Roms, II: Vorträge Des 10. Internationalen Limeskongresses in der Germania Inferior. Beihefte*

der Bonner Jahrbücher

38. Presented at the 10. Internationaler Limeskongresse in der Germania Inferior, Köln 1977, 245-246.

Wilkes 1979

J. J. Wilkes, *Importation and manufacture of stamped bricks and tiles in the Roman province of Dalmatia*, in: A. McWhirr (ed.), *Roman brick and tile: studies in the manufacture, distribution and use in the western empire*, BAR Internat. Ser. 68, Oxford 1979, 65-72.

Zabehlicky-Scheffenegger, Kandler 1979

S. Zabehlicky-Scheffenegger, M. Kandler, *Burnum I. Erster Bericht über die Kleinfunde der Grabungen 1973 und 1974 auf dem Forum*, Wien 1979.

Zaninović 1996

M. Zaninović, *Vojni značaj Tilurija u antici*, in: *Od Helena do Hrvata*, Zagreb 1996, 280-291.

Zaninović 2007

M. Zaninović, *Beneficarii consularis na području Delmata*, Prilozi Instituta za arheologiju u Zagrebu 24, Zagreb 2007, 181-184.