

Vector Control of the Induction Motor Based on Whale Optimization Algorithm

Original Scientific Paper

Fadhil A. Hasan*

University of Technology- Iraq,
Department of Electrical Engineering
Baghdad, Iraq
fadhil.a.hasan@uotechnology.edu.iq

*Corresponding author

Abstract – This paper presents the Whale Optimizing Algorithm (WOA) to improve the performance of the induction motors through vector control (VC). The optimization algorithm is utilized to tune the proportional-integral (PI) controllers in both the outer and inner controlling loops. The parameters of these controllers are crucial components of the control system. The WOA is inspired by the social behavior of humpback whales, which is a powerful meta-heuristic algorithm as compared to other techniques. The controlling system and the WOA are implemented using MATLAB-SIMULINK environments. Simulation results demonstrate that this approach significantly improves both dynamic and steady-state responses of the induction motor compared to other optimization techniques. Simultaneously, the success of the WOA in reaching the global optimal parameters can be realized by the significant reduction in computation time and iterations as compared to other methods. The results show a considerable enhancement of about 2% in rise time, 30% in overshoot, and 60% in settling time in accelerating mode in conjunction with a reference case. Also, it gives an improvement of about 9% in rise time, 11% in overshoot, and 64% in settling time in step response. This research contributes to the field of motor control by providing an efficient and reliable optimization method for enhancing the performance of induction motors for various industrial applications.

Keywords: Field-oriented control, Whale optimization, Induction motor, Optimum control

Received: February 19, 2024; Received in revised form: August 28, 2024; Accepted: September 17, 2024

1. INTRODUCTION

Induction motors (IM) have many technical features such as; low cost, minimum maintenance, high efficiency, durable build, and extended operating life for medium and high loads. Accordingly, they were employed in wide fields of industrial applications. Controlling strategies for electrical machines utilize several techniques depending on the machine's type and performance requirements. To achieve high-performance characteristics with these control approaches, various machine and controller parameters must be optimized [1]. These factors vary from one operation status to the other, such as temperature, saturation, frequency, and skin effect which impact on those parameters. As a result, the influence of all parameter variations in field-oriented control (FOC) for an induction motor at constant flux, field weakening regions, starting mode, and full-load condition is important in this article. The induction motor with field-oriented control or vector control (VC) emulates the direct current motor, and the stator and rotor flux components are vertical, so FOC

reserves high dynamic operation for IM controllers. This controlling method keeps the percentage of voltage and flux in the airgap at its rated level. The motor's physical components like flux, current, and voltage are changed as space vectors [1, 2].

Driving the IM for higher than the rated speeds, the applied voltage is maintained constant as the frequency rises, as in Scalar Control (SC). Even though vector control gives excellent performance and ensures high dynamic response, this behavior may be lost if the actual parameters are mismatched with the estimated parameters that are utilized in the controller. Hamdy [2], looks at how different parameters affect how well an induction motor with FOC at start-up and full load performs.

Vector control is a control strategy used to regulate the torque and flux of IM independently. Proportional-integral (PI) controllers are widely used in these control systems. The parameters of a PI controller need to be tuned to achieve the desired system performance. Tuning these parameters can be a challenging task,

for this goal, there are several techniques presented in the literature; Hasan et al. [3], present a combination of Kharitonov's theorem and particle swarm optimization (PSO) which improves the dynamic performance due to parameter variation. Dhaouia et al. [4], used the sliding mode based on a MARS controller with intelligent ANFIS which improves the transient response. Salih et al. [5], present a PI controller based on an artificial neural network to control the synchronous machine, this gives high dynamic response and stability.

In addition to such methods, a variety of optimization techniques have been used to tune PI controllers. The majority of optimization methods are classified as "computational intelligence algorithms," with stochastic gradient descent as the primary method of computation [6]. To produce intelligent programs, the strategy must incorporate principles of training, adaptability, and evolution. One of the most important features of these methods is that they help to find the best solution to complex optimization problems faster than standard optimization methods [7]. Mehedi et al. [8], present a comprehensive analysis of improved FOC incorporating intelligent controllers, which have led to improved performance metrics compared to traditional control methods. Shaija Daniel [9], utilizes two nature-inspired optimization algorithms, Gray Wolf Optimization (GWO) and Teaching-Learning-Based Optimization (TLBO), for the optimal tuning of PI controllers. The results show an improvement in the performance of the IM drives in terms of speed control, efficiency, and dynamic response. Albalawi et al. [10], present the application of ant colony optimization (ACO) to enhance the the steady-state and dynamic response. Tiacharoen et al. [11], propose applying the Bee optimization technique to the design of the FOC and the development of an intelligent control system. The results demonstrate improved efficiency and effectiveness in the control system, showcasing, the potential of Bee optimization as an achievable optimization method. Mohamed et al. [12], present genetic and PSO algorithms in the context of direct torque control of the IM. This method leads to improving the torque, speed, and torque ripple. Employing those optimization techniques is simple, able to avoid local optima, and compatible with many application problems in various fields, thus those algorithms have become popular.

Mirjalili et al. [13], present a new heuristic method called whale optimization algorithm that emulates the hunting behavior of the whales. this method is population-based and utilizes the seeking modes of exploration and exploitation. The WOA shows a competitive performance in terms of convergence, accuracy, and simplicity. The authors emphasize the effectiveness of the WOA in various domains, including engineering and software applications. The results demonstrate the significance of the WOA as a valuable addition to the group of optimization algorithms, presenting a nature-inspired approach to solving complex optimization problems. The compre-

hensive evaluation and positive outcomes make WOA a noteworthy choice for researchers and practitioners in optimization-related fields.

In this work, we investigate the utilization of the whale optimization algorithm to tuning the PI controllers in the vector control strategy, for the induction motor. The main goal emphasizes searching for the optimum values of the controller parameters that enhance both the steady-state and dynamic response. The evaluation criteria of the motor performance will be the integral time square error fitness function. This approach is the contribution of this work, which is characterized by simplicity compared to the complex and sophisticated optimization methods presented in previous works. The effectiveness of the proposed method is demonstrated by comparing it with the method used PSO technique presented in [3]. The challenge is achieving a balance between dynamic performance (rise time, overshoot, and settling time) and system stability, which traditional methods often fail to adequately resolve. The WOA's helical searching path is particularly effective in avoiding local optima, which helps prevent the algorithm from diverging and oscillating. This characteristic significantly reduces the computation time and number of iterations over other optimization techniques these are the main contribution of this work.

The paper is organized as follows; Section 2 presents the principles of vector control; Section 3 provides the adopted methodology in detail. Different types of fitness functions of the optimization algorithm are discussed in Sections 4; Sections 5 and 6 present the simulation results and conclusions.

2. VECTOR CONTROL

The induction motor may be operated with excellent transient behavior using vector or field-oriented control (FOC). It converts the IM's dynamic structure to an independent excitation DC machine [14]. The magnetic field is a function of the excitation current in a DC motor. Therefore, if the magnetic field is considered to maintain invariant and autonomous of the armature current, then the torque can be directly proportion to the magnetic field and armature current as [14, 15]:

$$T_e = k_m \cdot I_f \cdot I_a \quad (1)$$

Where; k_m is the machine constant, I_f is the field current and I_a is the armature current. It appears like an independently stimulated D.C motor when the induction motor is converted to the d-q plane. The (FOC) method separates the stator current into two parts: the first provides air gap magnetic flux and the second generates torque. The characteristics of these current components are linear [15], and they allow independent flux and torque control. Before returning to the rotor, these components are moved to the stator frame. The two components correspond to the field current on the

d-axis and the armature current on the q-axis of a separately activated DC motor [14]. As indicated in the phasor diagram in Fig. 1, the rotor field vector can be aligned along the d-axis. Fig. 2 shows the principles of vector control realization. The concept is represented in a synchronously rotating reference frame, and the inverter generates the supply voltages (v_a^s, v_b^s, v_c^s) proportional to the reference control signals (v_a^*, v_b^*, v_c^*). The stator current components (flux and torque) are employed as system controlling signals i_{ds}^{s*} & i_{qs}^{s*} respectively, which are reconverted to three-phase reference currents (i_a^*, i_b^*, i_c^*) and then converted to reference voltages (v_a^*, v_b^*, v_c^*) meanwhile the PI controllers [14, 15]. FOC can be utilized in one of two ways: directly or indirectly. The main difference is how they estimate the vectors ($\cos\theta_e$ and $\sin\theta_e$).

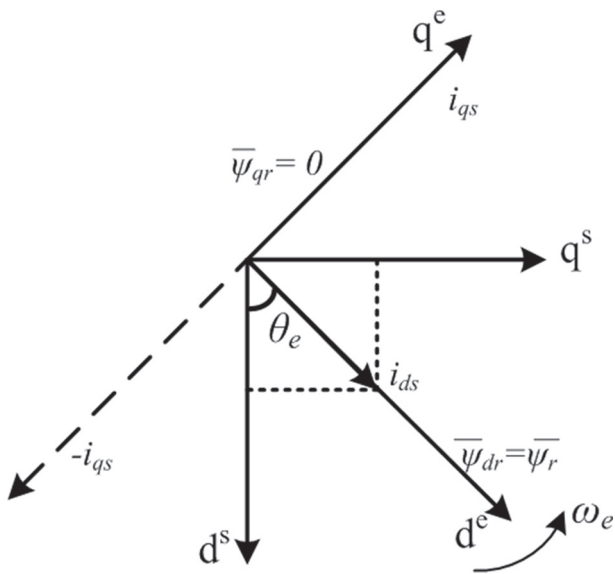

Fig. 1. Correct Rotor Flux Orientation

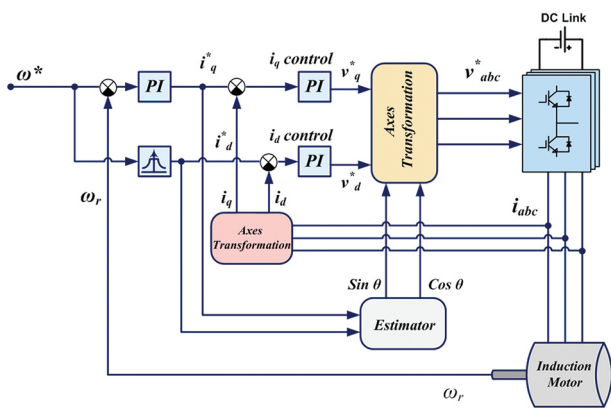

Fig. 2. Field Oriented Vector Control

3. WHALE OPTIMIZATION TECHNIQUE

Mirjalili and Lewis [13] proposed the whale optimization technique for solving numerical problems. The system mimics humpback whale intelligence hunting activity. This type of eating activity is known as "bubble-net feeding" and is only seen in humpback whales.

While surrounding prey during hunting, the whales blow bubbles in a circular pattern. Simply put, bubble-net hunting techniques involve humpback whales diving down around 12 meters, creating a spiral-shaped bubble around their prey, and then swimming up to the surface, tracking the bubbles. With the view of achieving these optima, the helical bubble-net can be mathematically modeled for hunting activity as in the following [5, 10, 16, 17]:

3.1. ENCIRCLING PREY

Humpback whales can track down and surround their prey. The WOA evaluates the current adequate tracking agents' status to be the objective target or near the optimal position, while the rest of the track agents will attempt to modify their location about the best search agent. The following equations describe this behavior [18]:

$$\vec{S} = |\vec{C} \cdot \vec{Y}^*(k) - \vec{Y}(k)| \quad (2)$$

$$\vec{Y}(k+1) = \vec{Y}^*(k) - \vec{A} \cdot \vec{S} \quad (3)$$

Where; k is the iteration pointer, \vec{Y}^* is the location vector of the best solution that has been found till the current iteration k , \vec{Y} is the location vector of each agent. The factors \vec{A} and \vec{C} are determined as following:

$$\vec{A} = 2\vec{a} \cdot b - \vec{a} \quad (4)$$

$$\vec{C} = 2b \quad (5)$$

Where; \vec{a} is reduced from 2 to 0 due to the iteration process, and b is a random value between 0 and 1.

3.2. ATTACKING WITH A BUBBLE-NET MECHANISM

The bubble-net technique is a mix of two different methods that can be modeled mathematically as the following [13]:

a. Shrunk encircling technique

By reducing the value of \vec{a} in the equation, this behavior of whales may be emulated in Equation (4). It's worth noting that \vec{a} reduces the fluctuation range \vec{A} . In other words, \vec{A} is a random number in the interval $[-a, a]$ where a is reduced from 2 to 0 during the duration of repetitions. The new location of a search agent can be defined anywhere between the initial location of the agent and the location of the current best agent by using random values for \vec{A} in $[-1, 1]$.

b. Upgrading the spiral location

To move like humpback whales, a spiral equation is set up between the location of the whale and the location of the prey, as shown:

$$\vec{S}' = |\vec{Y}^*(k) - \vec{Y}(k)| \quad (6)$$

$$\vec{Y}(k+1) = \vec{S}' \cdot e^{mn} \cdot \cos(2\pi n) + \vec{Y}^*(k) \quad (7)$$

Where; \vec{S}^i is the distance between the whale and the target, m is a constant that specifies the logarithmic form, and n is random in the range $[-1, 1]$.

Humpback whales do move in a spiral-shaped pattern while also swimming within a diminishing circle. Selecting the decreasing circular motion or the helical model tendency can be simulated throughout the rounds of the program by assuming a possibility of 50%. That is,

$$\vec{Y}(k+1) = \begin{cases} \vec{Y}^*(k) - \vec{A} \cdot \vec{S} & ; \text{if } g < 0.5 \\ \vec{S}^i \cdot e^{mn} \cdot \cos(2\pi n) + \vec{Y}^*(k) & ; \text{if } g \geq 0.5 \end{cases} \quad (8)$$

Where; g is a random number between 0 and 1.

3.3. SEARCHING FOR TARGETS

Most of the meta-heuristic techniques use random selection to get the best solution. Because the location of the optimum design in the bubble-net approach is unknown, whales explore for targets at random. In difference to the exploiting step, which is used \vec{A} in the region between $[-1, 1]$, this step uses \vec{A} as a random values vector larger than or equal to -1. According to this assumption, a hunting agent can go a long distance far from the reference whale. In exchange, the location of the hunt agent is updated based on a random selection of search agents, rather than the best search agent discovered thus far. These two activities can be expressed as follows [13, 17, and 18]:

$$\vec{S} = |\vec{C} \cdot \vec{Y}_{rand} - \vec{Y}| \quad (9)$$

$$\vec{Y}(k+1) = \vec{Y}_{rand} - \vec{A} \cdot \vec{S} \quad (10)$$

Where; \vec{Z}_{rand} represents a vector of random locations.

Whale optimization process begins with a set of randomly generated populations. The searching agents change their location according to the preceding reasons, at each iteration. WOA is an optimizer that works on a global scale. The WOA algorithm can quickly transition between exploration and exploitation due to adaptive change of the search vector \vec{A} . Furthermore, WOA only has two significant internal settings that may be changed. WOA's high exploration capabilities are due to the whales' position update system Equation (10). The effect of high exploitation and convergence is obtained from the derivation of Equations (7 and 8). Those equations demonstrate the WOA is very good at avoiding local optima and getting to the next solution quickly during each iteration.

3.4. WHALE OPTIMIZATION PROCEDURE

The algorithm can be explained as follows:

- Beginning by generating a collection of random agents for each variable.
- Extract a set of solutions and compare the current solutions with the best-obtained solution then update the agent's position accordingly.

- Reducing the factor \vec{a} from 2 to 0 to perform the shrinking encircling technique.
- Inspect the value of g an exchange between the shrinking technique and the helical technique.
- If $A \geq 1$, select an arbitrary search agent and if $A < 1$, select the best solution to update the location of searching agents.
- Ending the process when the satisfied termination constraint is achieved.

4. FITNESS FUNCTION

The error criteria are used to determine the fitness functions. There are a lot of criteria for evaluating controller performance, and the Integral time of Absolute Error (ITAE) criterion is used in this study [19]. The equation gives the measure cumulative error of the motor performance at certain operation intervals:

$$FF_{ITAE} = \int_0^T t|e(t)| dt \quad (11)$$

The ITAE uses a time-weighted error weighting scale that gives more weight to error values at a certain time (T) to account for the predicted steady-state time.

The second performance metric is the Integral Square Errors (ISE) constraint.

$$FF_{ISE} = \int_0^T (e(t))^2 dt \quad (12)$$

There are also absolute Errors (ITSE) compounded by the Integral of Time (T)

$$FF_{ITSE} = \int_0^T t(e(t))^2 dt \quad (13)$$

The period spans from 0 to T , with T being the amount of interval for a unit step input to bring the system to a steady state.

As shown by the MSE (mean square error),

$$FF_{MSE} = \frac{1}{T} \int_0^T (e(t))^2 dt \quad (14)$$

All these fitness functions represent a comprehensive evaluation both of dynamic and steady-state responses. It is worthwhile to say that when the advantage of a fast system needs minimum achievable values for the transient response, then the maximum overshoot, settling time, and rising time are typically regarded as crucial.

5. SIMULATION RESULTS

The presented method of developing the controllers of the vector control of the IM is recognized by being implemented using the MATLAB-SIMULINK program. The optimization approach was accomplished in off-line mode to evaluate the controllers' parameters singly. The nameplate parameters of the investigated induction machine are listed in Table 1.

Table 1. Machine parameters

Motor Parameters	Value
Rated Torque	800 Nm
Frequency	50 Hz
Rated voltage	460 V (line-line)
Number of poles	4
Stator inductance	0.302 mH
Stator winding resistance	14.8 mΩ
Rotor inductance	0.303 mH
Rotor resistance	9.3 mΩ
Mutual inductance	10.5 H
Rotor inertia	3.1 kgm ²
Friction coefficient	0.08 N.m.s
Nominal flux	0.73 Wb

The parameters of the WOA were adjusted to 100 inspection agents, 100 iterations, and two searching dimensions representing the two variables (k_p , k_i) of the three PI controllers in the FOC system. The optimization process was utilized by developing a MATLAB sub-routine in offline mode. The movement in the whale optimization searching agents during the 100 iterations is illustrated in Fig. 3. Obviously, the agents quickly collected toward the global optima in the helical tracking path as shown by the red solid curve. This helical trajectory path gives the strength of this technique by bypassing all local optimal points which prevent the algorithm from divergence and oscillation. The absolute locations of the agents after ending the process are listed in Table 2, which presents the founded optimum parameters for the three PI controllers in the system (speed, torque, and flux controllers).

Table 2. The optimum parameters

Controller	k_p	k_i
Speed	735.4	8970.8
Torque (iq)	2.3	11.6
Flux (id)	80.5	34.2

To investigate the effectiveness of the obtained parameters of the FOC controllers, the overall system must be tested by different operating modes. Firstly, the controller investigates the four-quadrant operation mode at the full and no-load conditions as depicted in Fig. 4. The figure illustrates the rotor speed, the shaft torque, and phase current. Obviously, from this, the response shows a fast starting time of about 0.17s, a small overshoot of approximately 1% over the nominal speed, and a steady-state time of 0.21s. Secondly, to realize the features of the proposed controller a comparison performance in conjunction with the FOC model presented in [3], in which a robust PI-PSO controller of the IM motor was presented. The accelerating

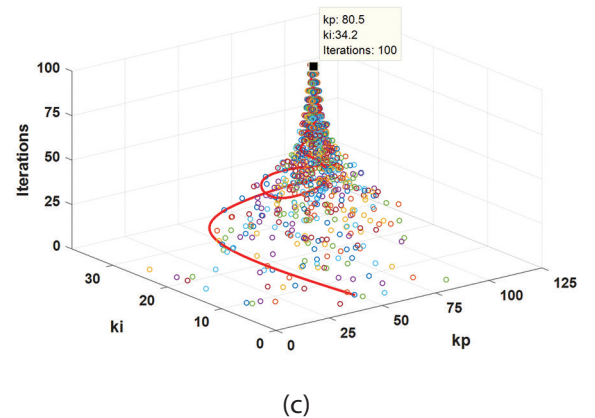
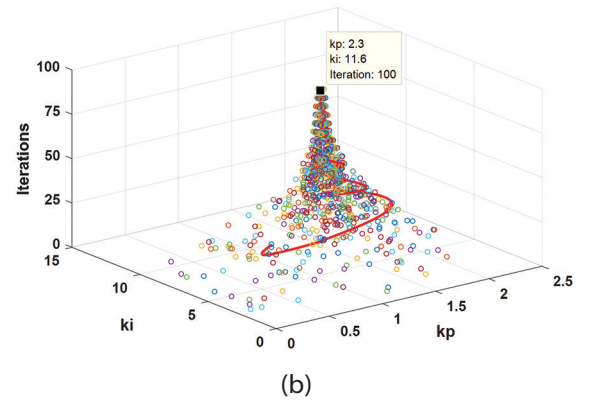
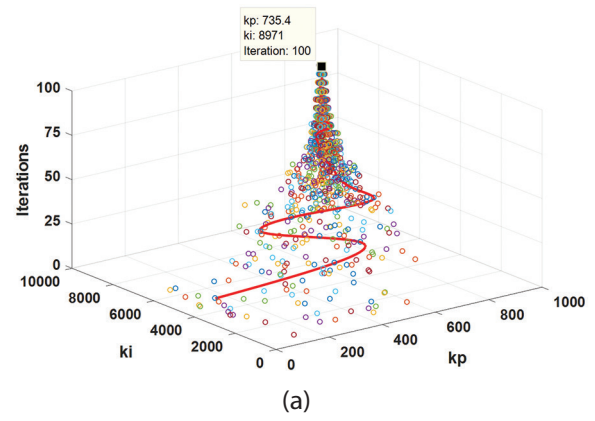
**Fig. 3.** Optimization agents' trajectories; (a) Speed controller parameters, (b) Torque controller parameters, (c) Flux controller parameters.

and decelerating operation under full-load conditions is shown in Fig. 5. From this comparison one can note that the motor speed is perfectly tracking the reference speeds. Also, the estimated and actual electromagnetic torque is identical to the load torque. Moreover, the step response comparison between the proposed controller and reference case is shown in Fig. 6. The dynamic constraints obtained from these comparison cases are summarized in Table 3.

Finally, the reference speed-tracking performance for different speed commands, at full-load conditions, is illustrated in Fig. 7. The dynamic constraints obtained from these comparison cases are summarized in Table 3.

Table 3. Time domain constraints comparison

Constraints	Ramp response		Step response	
	Proposed controller	Matlab example	Proposed controller	Matlab example
Rise time (s)	0.455	0.465	0.145	0.16
Overshoot %	0.7	1	0.8	0.9
Shoot time (s)	0.46	0.466	0.154	0.17
Settling time (s)	0.5	0.8	0.18	0.5

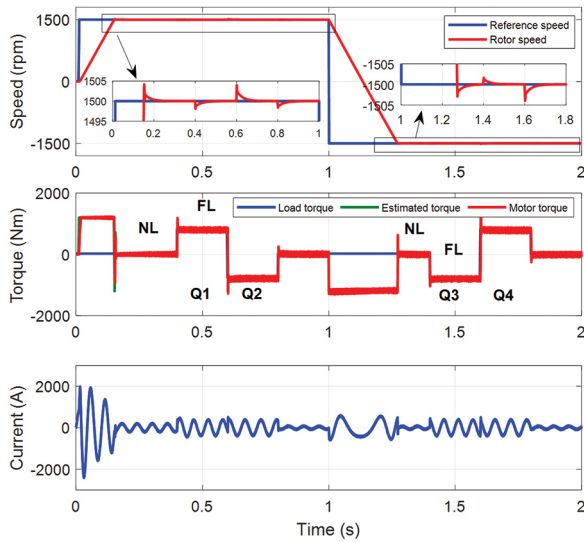

Fig. 4. Four-quadrant operating mode

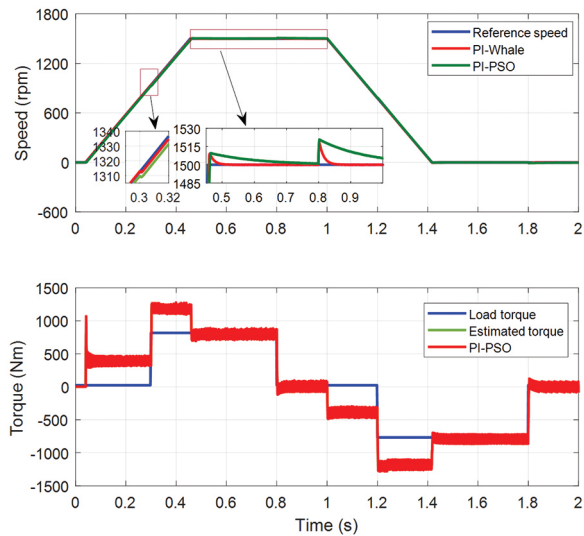

Fig. 5. Accelerating and decelerating comparison

6. CONCLUSIONS

The paper proposes a metaheuristic approach for enhancing the performance of a three-phase induction motor. Particularly, the research interests are in applying the whale optimization method to control the IM utilizing the VC method. The optimized control strategy incorporates a searching process for the PI controller parameters. The WOA shows a unique behavior as compared with other optimization techniques, in terms of the number of iterations and fast computing time. The helical searching path of the population agents enables

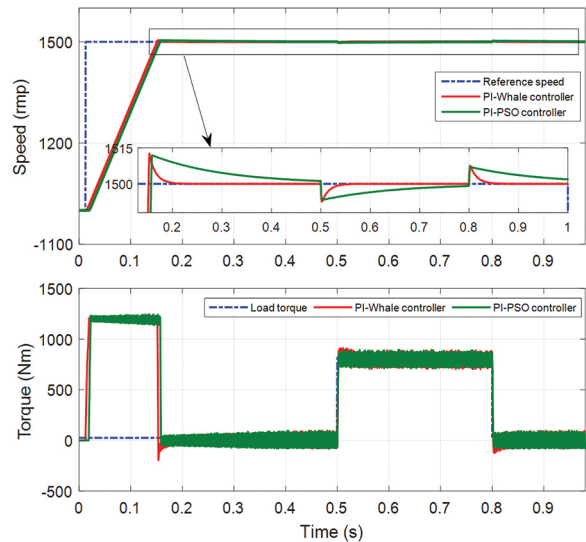

Fig. 6. Step response comparison

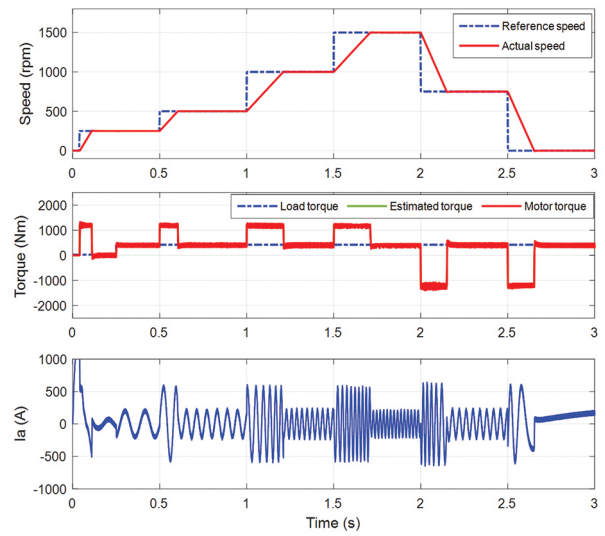

Fig. 7. Different command speed tracking

them to bypass the local optima regions, which prevents the algorithm from divergence and oscillation. The obtained PI controllers showcased enhanced performance in controlling motor speed. Compared to the PI-PSO, the proposed PI-WOA gives an improvement of about 2% in rise time, 30% in overshoot, and 60% in settling time in accelerating mode. Also, it gave an improvement of about 9% in rise time, 11% in overshoot, and 64% in settling time in step response in conjunction with the reference case. This suggests that the WOA method effectively fine-tuned the control parameters, leading to better dynamic response and overall motor performance.

7. REFERENCES

- [1] R. Krishnan, A. S. Bharadwaj, "A Review of Parameter sensitivity and adaptation in Industrial vector controlled Induction motor drive system", *IEEE Transactions on Power Electronics*, Vol. 6, No. 4, 1991, pp. 219-225.
- [2] H. M. Soliman, "Effect of the Parameters Variation for Induction Motor on its Performance Characteristics with Field Oriented Control Compared to Scalar Control", *International Journal of Engineering Research & Science*, Vol. 2, No. 8, 2016.
- [3] F. A. Hasan, A. T. Humod, L. J. Rashad, "Robust decoupled controller of induction motor by combining PSO and Kharitonov's theorem", *Engineering Science and Technology, an International Journal*, Vol. 23, No. 6, 2020, pp. 1415-1424.
- [4] A. Salih, A. Humod, F. A. Hasan, "Optimum Design for PID-ANN Controller for Automatic Voltage Regulator of Synchronous Generator", *Proceedings of the 4th Scientific International Conference Najaf, Al-Najef, Iraq*, 29-30 April 2019, pp. 74-79.
- [5] N. H. M. Nezhad, M. G. Niasar, C. W. Hagen, P. Kruit, "Comparison of Different Optimization Techniques in Electron Lens Design", *Proceedings of the 9th International Conference on Optimization and Applications*, Abu Dhabi, United Arab Emirates, 2023, pp. 1-5.
- [6] A. Kumar, S. S. Badini, V. Verma, "Comparative Evaluation of Different Meta-heuristic Optimization Based Tuning of PI Controllers for Vector Controlled Induction Motor Drive", *Proceedings of the 2nd International Conference on Emerging Frontiers in Electrical and Electronic Technologies*, Patna, India, 24-25 June 2022, pp. 1-6.
- [7] I. M. Mehedi, N. Saad, M. A. Magzoub, U. M. Al-Saggaf, A. H. Milyani, "Simulation Analysis and Experimental Evaluation of Improved Field-Oriented Controlled Induction Motors Incorporating Intelligent Controllers", *IEEE Access*, Vol. 10, 2022, pp. 18380-18394.
- [8] P. J. Shaija, A. E. Daniel, "Optimal Tuning of PI Controllers for IM Drive using GWO and TLBO Algorithms", *Proceedings of the Fifth International Conference on Electrical, Computer and Communication Technologies*, Erode, India, 22-24 February 2023, pp. 1-9.
- [9] H. Albalawi, S. A. Zaid, M. E. El-Shimy, A. M. Kassem, "Ant Colony Optimized Controller for Fast Direct Torque Control of Induction Motor", *Sustainability*, Vol. 15, No. 4, 2023, p. 3740.
- [10] S. Tiacharoen, T. Chatchanayuenyong, "Design and development of an intelligent control by using bee colony optimization technique", *American Journal of Applied Sciences*, Vol. 9, No. 9, 2012, p. 1464.
- [11] M. Elgbaily, F. Anayi, M. Packianather, "Genetic and particle swarm optimization algorithms based direct torque control for torque ripple attenuation of induction motor", *Materials Today: Proceedings*, Vol. 67, No. 4, 2022, pp. 577-590.
- [12] S. Mirjalili, A. Lewis, "The Whale Optimization Algorithm", *Advances in Engineering Software*, Vol. 95, 2016, pp. 51-67.
- [13] B. Wu, M. Narimani, "Control of Induction Motor Drives", *High-Power Converters and AC Drives*, Wiley-IEEE Press, 2017, pp. 321-352.
- [14] P. Girovsky, J. Timko, J. Zilková, V. Fedák, "Neural Estimators for Shaft Sensorless FOC Control of Induction Motor", *Proceedings of 14th International Power Electronics and Motion Control Conference*, Ohrid, Macedonia, 6-8 September 2010, pp. T7-1-T7-5, 2010.
- [15] A. M. Mosaad, M. A. Attia, A. Y. Abdelaziz, "Whale optimization algorithm to tune PID and PIDA controllers on AVR system", *Ain Shams Engineering Journal*, Vol. 10, No. 4, 2019, pp. 755-767.
- [16] H. Kamil et al. "Design and Simulation of a Portable Copper Tubes Induction Brazing Tool for PV System Application", *Journal of Physics: Conference Series*, Vol. 1804, 2021.
- [17] A. A. Kumar, S. M. G. Kumar, "Application of Whale Optimization Algorithm for tuning of a PID controller for a drilling machine", *Proceedings of the International Conference on Advancements in Automation, Robotics & Sensing*, Coimbatore, India, 13-15 December 2018.
- [18] M. M. Mwembeshi, C. A. Kent, S. Salhi, "A genetic algorithm-based approach to intelligent modeling and control of pH in reactors", *Computers & Chemical Engineering*, Vol. 28, No. 9, 2004.
- [19] F. A. Hasan, H. Q. Hameed, L. J. Rashad, "Robust field oriented control of PMSM using Lyapunov theorem and particle swarm optimization", *Journal Européen des Systèmes Automatisés*, Vol. 57, No. 2, pp. 487-496.