

DETERMINATION OF DIAMETRAL ERROR USING FINITE ELEMENTS AND EXPERIMENTAL METHOD

Received – Prispjelo: 2008-10-25
Accepted – Prihvaćeno: 2009-07-15
Preliminary Note – Prethodno priloženje

This study concerns experimental and numerical analysis on a one-sided bound workpiece on the lathe machine. Cutting force creates deflection on workpiece while turning process is on. Deflection quantity is estimated utilizing Laser Distance Sensor (LDS) with no contact achieved. Also diametral values are detected from different sides of workpiece after each turning operation. It is observed that diametral error differs due to the quantity of the deflection. Diametral error reached a peak where deflection reached a peak. Model which constituted finite elements is verified by experimental results. And also, facts which caused diametral error are determined.

Key words: turning, diametral error, laser distance sensor, deflection, finite elements

Određivanje odstupanja izmjere promjera pomoću metode konačnih elemenata i eksperimenta. Ova studija bavi se eksperimentalnom i numeričkom analizom obratka učvršćenog s jedne strane na tokarskom stroju. Rezna sila izaziva savijanje radnog komada za vrijeme procesa tokarenja. Iznos progiba je ocijenjen korištenjem bezkontaktnog senzora za mjerenje udaljenosti (Laser Distance Sensor LDS). Također su određene vrijednosti promjera s različitih strana obratka nakon svake operacije tokarenja. Nađeno je da se odstupanje izmjere promjera razlikuje obzirom na iznos progiba. Odstupanje veličine promjera dostiže svoju najvišu vrijednost na mjestu gdje je progib najveći. Model koji se temelji na konačnim elementima je verificiran pomoću eksperimentalnih rezultata. Također su utvrđene činjenice koje uzrokuju odstupanje promjera.

Glavne riječi: tokarenje, odstupanje izmjere promjera, senzor za mjerenje udaljenosti, progib, konačni elementi.

INTRODUCTION

Many manufacturing defects could be seen in cylindrical turning. Some of these defects are: elastic deformation of work-piece, nonlinear backlash of cutting set – machine – workpiece, unknown geometry of untreated part, thermal deformations, vibration of set and machine. Deflection of workpiece under cutting forces will cause different levels of processing of workpiece [1]. Nonlinear backlash of cutting set – machine – workpiece will cause elastic deformation in structures of fasteners and machine [1, 2]. Friction occurred while abrasive machining and heat generated by plastic deformation alters geometry of cutting [3]. Cutting forces influence error estimations. In numerical examples formed along the workpiece axis in order to estimate cutting forces and diametral errors, cutting conditions affect manufacturing process. Most essential of these is corrosion of set which changes geometry of set [4, 5]. Another one is vibration which occurs amongst cutting set–machine–workpiece final form of workpiece in cylindrical turning will not conserve the diameter it had at the beginning of the process due to deflection of

workpiece due to cutting forces [6]. A developed processing method is required in order to achieve higher exactitude in diameter measurements of workpiece after turning. Computer assisted error correction systems are developed to achieve higher exactitude in turning process [7, 8].

In this study, diametral error occurred during turning process of a cylindrical piece has been theoretically and experimentally analyzed. Finite element method is applied on workpiece which is one end bound.

DIAMETRAL ERROR IN TURNING

A geometrical analysis is succeeded in order to estimate diametral error in turning process [2]. Deflection on workpiece in Figure 1 is shown as δ_{wx} . This deflection is caused by radial force F_r and axis force F_a . Similarly, δ_{wy} is deflection in y direction. This deflection is caused by F_t tangential force. Maybe slightly but F_r and F_t forces in x and y directions will also cause set deflection of δ_{tx} , δ_{ty} . $D_p(z)$ shown in Figure 3 is defined in terms below.

$$D_p = 2 \sqrt{\left(\frac{D}{2} - d + \delta_{wx}\right)^2 + \delta_{wy}^2} \quad (1)$$

A. Karabulut, Faculty of Technical Training, Afyon Kocatepe University, Afyonkarahisar, Turkey.

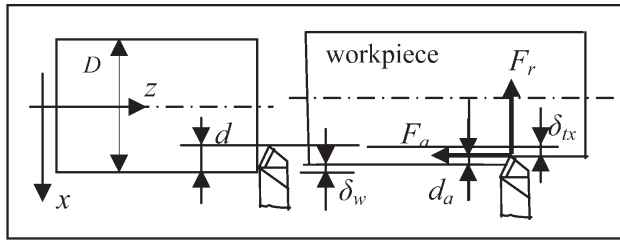

Figure 1. Estimated diameters achieved after turning process

Eq. 1 can be written as due to small deflection of cutting tools is defined this way. Algebraic sizes of deflection values possess symbols as to xyz -system of coordinates. Estimated depth of cut d_a and diametral error ΔD defined

$$d_a = \frac{D - D_p}{2} \quad (2)$$

$$\Delta D = D_p - D + 2d = D_p - D_n \quad (3)$$

within these equities. $D_n = D - 2d$ is diameter after turning process [9].

NUMERICAL MODALITY OF CLAMPED BY CHUCK IN TURNING

In order to model elastic deformation in turning workpiece, finite element method is used in this study. Two noded beam elements with two nodes are preferred for numerical modeling. Figure 2 shows finite element model and boundary conditions of workpiece. M_1 moment occurs in number 1 node due to the fact that the beam is bound to chuck, in number 2 node radial force which arises during shearing occurs.

Beam element with two nodes is utilized for the beam shown in Figure 2. Length of element utilized in model is taken as L . In finite element formulation, stiffness matrix of beam element $[k]$ is often defined as

$$k = \int B^T EIB dz \quad (4)$$

where $[B]$ is strain displacement matrix, equal to second derivation due to z of shape functions:

$$[B] = \frac{d^2}{dz^2} N_i \quad (5)$$

N_i here is shape function of each node. So matrix of $[B]$ is achieved as

$$[B] = \frac{1}{L^3} [-6L + 12z - 4L^2 + 6zL, 6L - 12z - 2L^2 + 6zL] \quad (6)$$

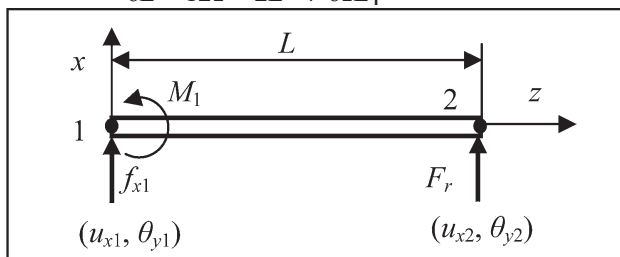

Figure 2. Finite element model of work-piece for xz plane

When equality (6) is placed in its place in equality (4) element stiffness matrix for two noded element is achieved as

$$k = \frac{EI}{L^3} \begin{bmatrix} 12 & 6L & -12 & 6L \\ 6L & 4L^2 & -6L & 2L^2 \\ -12 & -6L & 12 & -6L \\ 6L & 2L^2 & -6L & 4L^2 \end{bmatrix} \quad (7)$$

Here E is elasticity module of workpiece, I is inertia moment and L is the length of element.

$$[k][u] = [f] \quad (8)$$

$[u]$ is displacement vector, $[f]$ is load vector. Due to finite element model, $[u]$ and $[f]$ vectors are

$$u = [u_{x1} \ \theta_{y1} \ u_{x2} \ \theta_{y2}]^T \quad (9)$$

$$f = [f_{x1} \ M_1 \ f_r \ 0]^T \quad (10)$$

Due to boundary conditions shown in Figure 2, $u_{x1} = \theta_{y1} = 0$. Here, F_r is radial, and F_t is tangential force which occurred during cutting process. F_t cutting force results in torsion of the cylindrical bar. In this study, the cutting force F_t is omitted and taken as zero.

Stiffness matrix of element due to this is achieved as

$$\frac{EI}{L^3} \begin{bmatrix} 12 & -6L \\ -6L & 4L^2 \end{bmatrix} \begin{bmatrix} u_{x2} \\ \theta_{y2} \end{bmatrix} = \begin{bmatrix} F_r \\ 0 \end{bmatrix} \quad (11)$$

Determination of cutting forces

Material of workpiece is AISI 1045 steel, with elasticity module of 205 GPa, and yield strength of 598 MPa. Sintered carbide cutting tool is used.

Despite the fact that the cutting forces occurred during turning were experimentally estimated, results may be far from reliability. They were taken from the study [10] in turning process of AISI 1045 material.

Experimental findings

A workpiece of different diameters in 150 mm length is turning; 0,5 mm and 1 mm of depth of cut from 24 mm to 14 mm, two samples are turning at the cutting rate of 0,420 and 0,840. \ddot{a} value shows quantity of treatment between cutting set and workpiece is observed in Figure 4a. Cutting set propels the workpiece to in x axis direction, and then cutting set starts raising turnings in approximate depth of cut of d_a . The quantity d_a varies due to deflection amount of workpiece. Figure 4b-c shows diverge of b after the cutting set leaves workpiece when the shearing is over. Figure 4b is A end and 4c is B end of workpiece.

EXPERIMENTAL SET UP

One end of shaft which will be processed on lathe machine is bound to chuck from one end and the other end is free (Figure 3a). Shearing set processes workpiece left to right with a particular chip depth. Dia-meter of shaft reduces on each round of process. Driver and computer

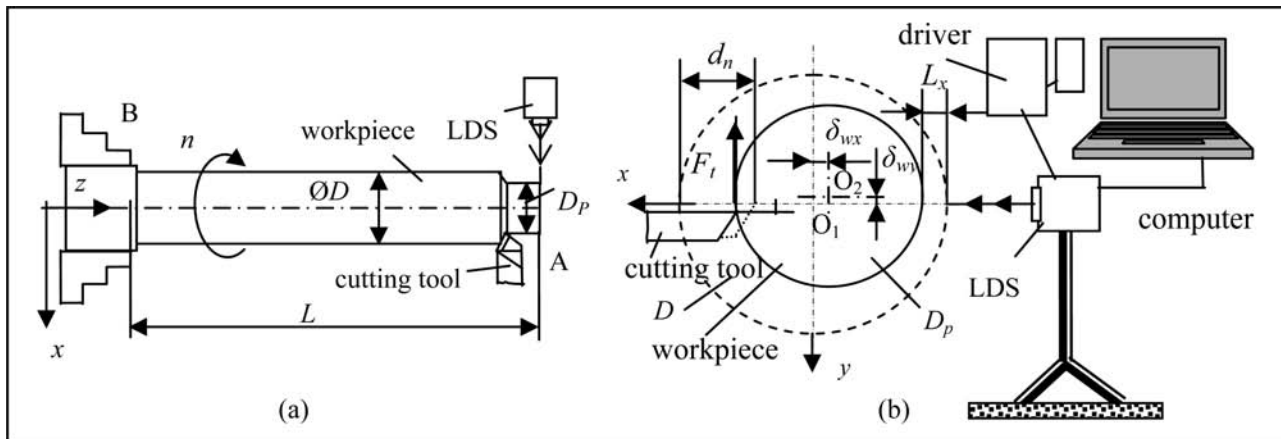

Figure 3. Experimental measurement system

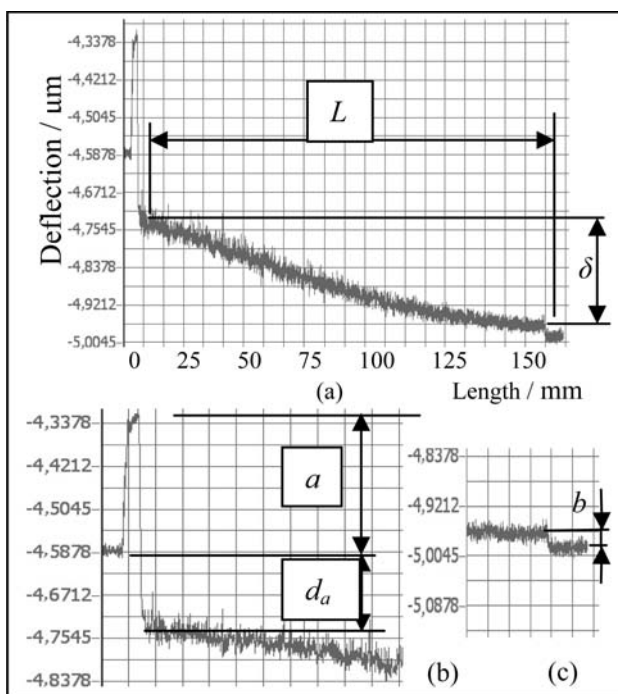

Figure 4. Deflection graphic of 15,08 mm diameters of a workpiece

comprise the equipment utilized in experiment. LDS should keep still during the measurement. First center of work-piece is O_1 and it is O_2 after deflection. Deflection in x -axis is δ_{wx} and y -axis is δ_{wy} shown in Figure 3b.

Deflection and diametral errors

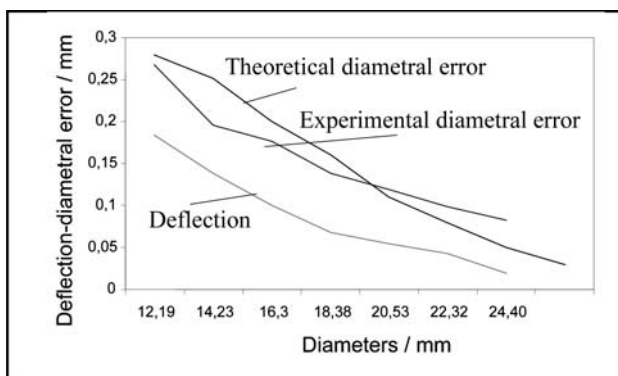

Figure 5. Comparison of deflection and diametral errors

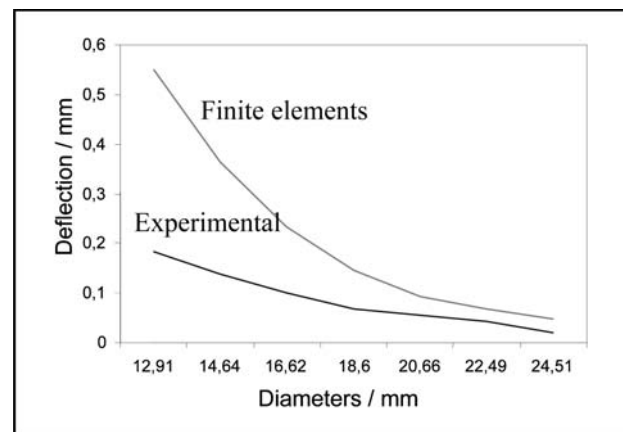

Figure 6. Deflection quantity alteration due to diameters

Deflection and diametral error alters proportionally. Deflection and diametral errors decrease as diameter of workpiece increases, shown in Figure 5. Diametral error is more than deflection where workpiece has the same diameter. Experimental and theoretical results match. In Figure 6, results between experimental and theoretical increase as diameter of workpiece decreases. Results approach each other as diameter increases. Cutting forces will be different in theoretical estimation and experimental study.

Diameter difference between two ends

It was observed that the diameters between both sides of workpiece are different and also it is verified experimentally that diameter at end point d_A is greater than the end d_B to which workpiece is bound. Increase of cut depth increases the diametral difference between two ends. As it is shown in Figure 7, diametral error is almost 0 at d_B . Vertical axis in graphic shows the d_A-d_B difference. Figure 8 shows diametral error due to different diameters turning.

Estimated cut depth and deflection

Estimated depth of cut d_a could also be called as experimental. As long as a deflection occurs on workpiece, estimated cut depth is always less than nominal cut depth d_n . Nominal cut depth is 1mm and estimated cut depth

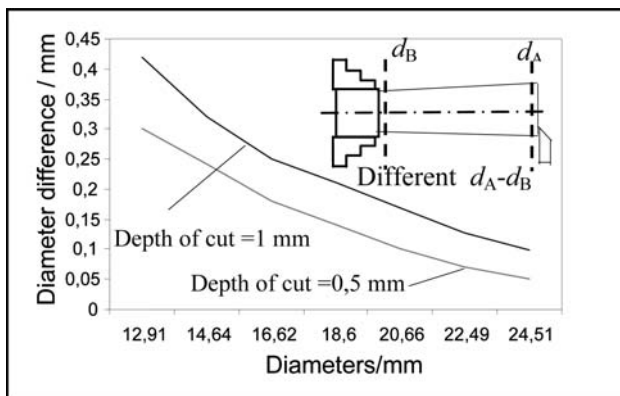

Figure 7. Diameter alteration between two ends of workpiece after turning

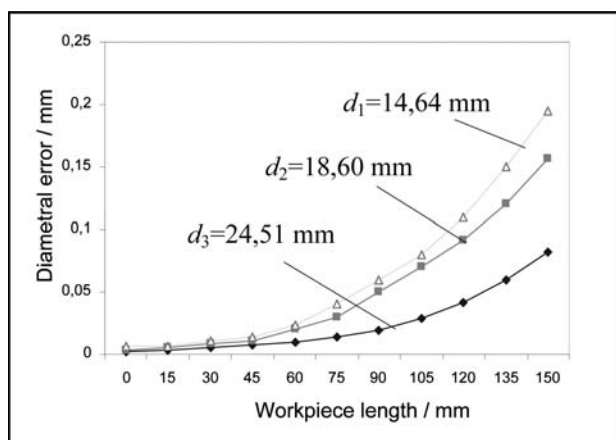

Figure 8. Comparison of diametral errors in different diameters

seems below that in Figure 9 as diameter increases, estimated cut depth increases and deflection decreases.

Factors affecting diametral error

Results of experimental and theoretical researches present the parameters affecting diametral error on workpiece turning as: cut depth, feed ratio, set geometry, coolant guard utilized, corrosion angle of set and processability of workpiece.

CONCLUSION

Experiment, in order to determine diametral error of workpiece which is bound on one end, is performed. Deflection values of workpieces are noted utilizing LDS. Information is evaluated with software. Diametral error has been measured using micrometer and compared to results of experiments. Results achieved due to finite element method are compared to results of experiments. Numerical values are succeeded also using the equalities formed to indicate diametral errors. Results shown below are achieved due to experimental and theoretical information:

1. Deflection quantity and diametral error have direct proportional relation.
2. Greatest diametral error occurs on the free end of workpiece.

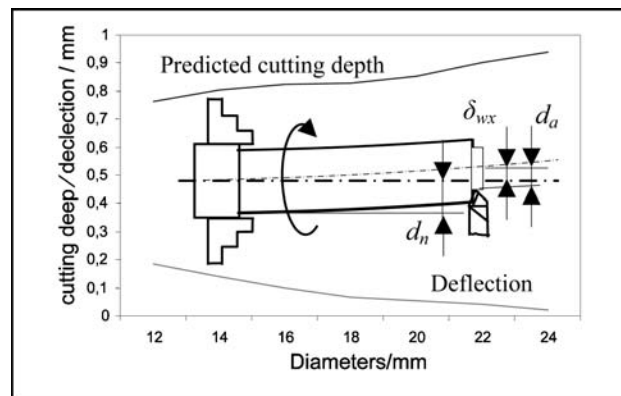

Figure 9. Comparison of deflection and estimated cut depth

3. Diametral error increases as diameter decreases on two workpieces with the same length.
4. Experimental and theoretical results have harmony.
5. Deflection of workpiece increases as chip length and feed ratio increase due to the fact that cutting force has direct proportional connection with depth of cut and feed rate.
6. Rigidity of workpiece fasteners has the effect to decrease diametral error.

REFERENCES

- [1] L.Z. Qiang, Finite element calculation of the deformation of multi-diameter workpiece during turning, *Journal of Material Processing Technology* 98(2000), 310-316.
- [2] A.V. Phan, L. Baron, J.R.R. Mayer, G. Cloutier, Finite element and experimental studies of diametral error in cantilever bar turning, *Applied Mathematical Modeling* 27 (2003), 221-232.
- [3] D.A. Stephenson, M.R. Barone, G.F. Dargush, Thermal expansion of the workpiece in turning, *Transactions of ASME* 117 (1995), 542-550.
- [4] S. Yang, J. Yuan, J. Ni, Real time cutting force induced error compensation on a turning center, *International Journal of Machine Tools and Manufacture* 37 (1997), 1597-1610.
- [5] D.N. Reshetov, V.T. Portman, *Accuracy of Machine Tools*, ASME Press, New York, 1998.
- [6] L. Kops, M. Gould, M. Mizrach, Improved analysis of the accuracy in turning, based on emerging diameter error, *Journal of Engineering for Industry* 115 (1993), 253-257.
- [7] Y. El. Karamany, Turning long workpiece by changing the machine parameters, *Int. J. Mach. Tools Des. Res.* 24 (1984), 1-10.
- [8] S. Yang, J. Yuan, J. Ni, Accuracy enhancement of a horizontal machining center by real-time error compensation. *J. Manuf Systems* 15, 2 (1996), 113-124.
- [9] G. Jianliang, H. Rongdi, A united model of diametral error in slender bar turning with a follower rest, *International Journal of Machine Tools and Manufacture* 46 (2006), 1002-1012.
- [10] K. Aslantaş, I. Uçun, I. Uçun, Finite element modeling of machining of AISI 1045 with ceramic cutting tool, *Int. J. Material and Product Technology* (in press) (2009).

Note: The responsible lector for the English language is Prof. Veronika Mišura