

Evaluation of the effect of the moisture content of coal dust on the prediction of the coal dust explosion index

The Mining-Geology-Petroleum Engineering Bulletin
UDC: 622.8; 662.9
DOI: 10.17794/rgn.2020.1.4

Original scientific paper



Hadis Moradi¹; Farhang Sereshki¹; Mohammad Ataei¹; Mohsen Nazari²

¹ Faculty of Mining Petroleum & Geophysics Engineering, Shahrood University of Technology, Shahrood, Iran.

² Shahrood University of Technology, Shahrood, Iran.

Abstract

Exploring the mechanism of coal dust explosions is essential for the development of safety techniques to prevent coal dust explosions. An explosion index can be used to estimate explosion severity. In this study, the moisture content parameter, one of the intrinsic characteristics of coal dust, was used to estimate the explosion index. For this purpose, 32 samples of coal with different moisture content were collected from different mines in Iran and were prepared as coal rounds. The coal dust explosion process was carried out in a 2-litre closed chamber. After determining the most important and influential parameters, prediction models of the explosion index were presented using linear regression. For this purpose, 75 percent of data was randomly assigned for training and 25 percent of data was used for testing and validation. The performance of these models was assessed through the root mean square error (RMSE), the proportion of variance accounted for (VAF), the mean absolute percentage error (MAPE) and the mean absolute error (MAE). Then the results of the laboratory method were compared with the results of the regression model. The results show that there is a good correlation between the laboratory results and the predictive model obtained through linear regression analysis.

Keywords:

coal dust explosion, explosion index, moisture content, closed chamber, explosion intensity, regression analysis.

1. Introduction

Coal floating dust is always produced in different locations of underground coal mines (Li et al., 2018a; Hu et al., 2010). In coal mines, a coal dust explosion is usually triggered by a gas explosion (Zhang et al., 2009). This is known as the domino effect and is shown in Figure 1 (Cao et al., 2017). In general, the study of explosion events in coal mines has shown that in most of the explosions, coal dust is usually involved to some extent (Hao and Li, 2011). So there are always safety issues like coal dust explosions in underground coal mines and other related industries (Bi and Wang, 2008). Therefore, analysis of the intrinsic properties of coal dust and their explosive parameters are important factors in detecting the coal dust explosion mechanism.

Moisture content is one of the characteristics of coal dust that plays an important role in the explosion of coal dust (Ajrash et al., 2017). Figure 2 shows the reaction of coal dust particles in the presence of moisture during the explosion process. In general, coal dust particles undergo two different stages at the time of the dust explosion: The separation stage and the homogeneous and heterogeneous combustion stage (Russo and Benedetto,

to, 2013). In the first phase, the coal particles are heated by flammable energy and volatile gases and form the combustion heat of the coal. The higher the moisture content of the coal dust particles, the lower the combustion heat.

Figure 3 shows a view of the moisture surrounding a coal dust particle. Moisture is first absorbed by the heat of the surrounding environment directly into the coal particles, then heat is applied to the steam during the liquid phase change. Even if wet dust is exposed to fire, the heat is first consumed by evaporation and then burned (Yu et al., 2012).

In order to study the parameters of coal dust explosion severity, many experiments have been carried out and the results of these investigations have been used to increase production safety in industry (Garcia-Torrent et al., 2016; Ajrash et al., 2015). However, the determination of the explosion index is one of the most important parameters in evaluating the explosion risk. Therefore, in order to prevent the explosion of coal dust, adequate studies and investigations of the mechanism of coal dust explosion should be carried out (Ranganathan et al., 2018). The explosion index of coal dust depends on various parameters, including environmental conditions and inherent characteristics of coal dust (Moradi et al., 2019). Moisture content is one of the most important factors in dust explosion studies (Yu et al., 2012).

Corresponding author: Hadis Moradi
h.moradiphd2017@gmail.com

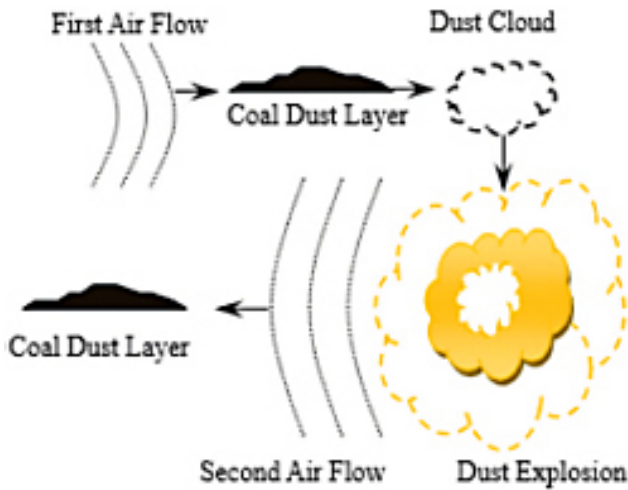

Figure 1: Domino effect of dust explosion (Cao et al., 2017).

Given the important role of this factor and studies in this area, the role of moisture on coal dust explosion is not well understood. Recently, research into the effect of moisture content on coal dust explosions has become more important.

Saffari et al., (2019b) investigated the effect of humidity on the spontaneous combustion of coal. According to their research results, when the moisture content is below 20%, the coal sample oxidizes more rapidly. Thus in coal, moisture content less than 20% has a large effect on the heat released during low temperature oxidation.

Kucuk et al., (2003) investigated the effect of moisture and particle size on the spontaneous combustion of coal. According to the study, moisture reduces the sensitivity of coal to spontaneous combustion, but decreasing the particle size increases the spontaneous combustion

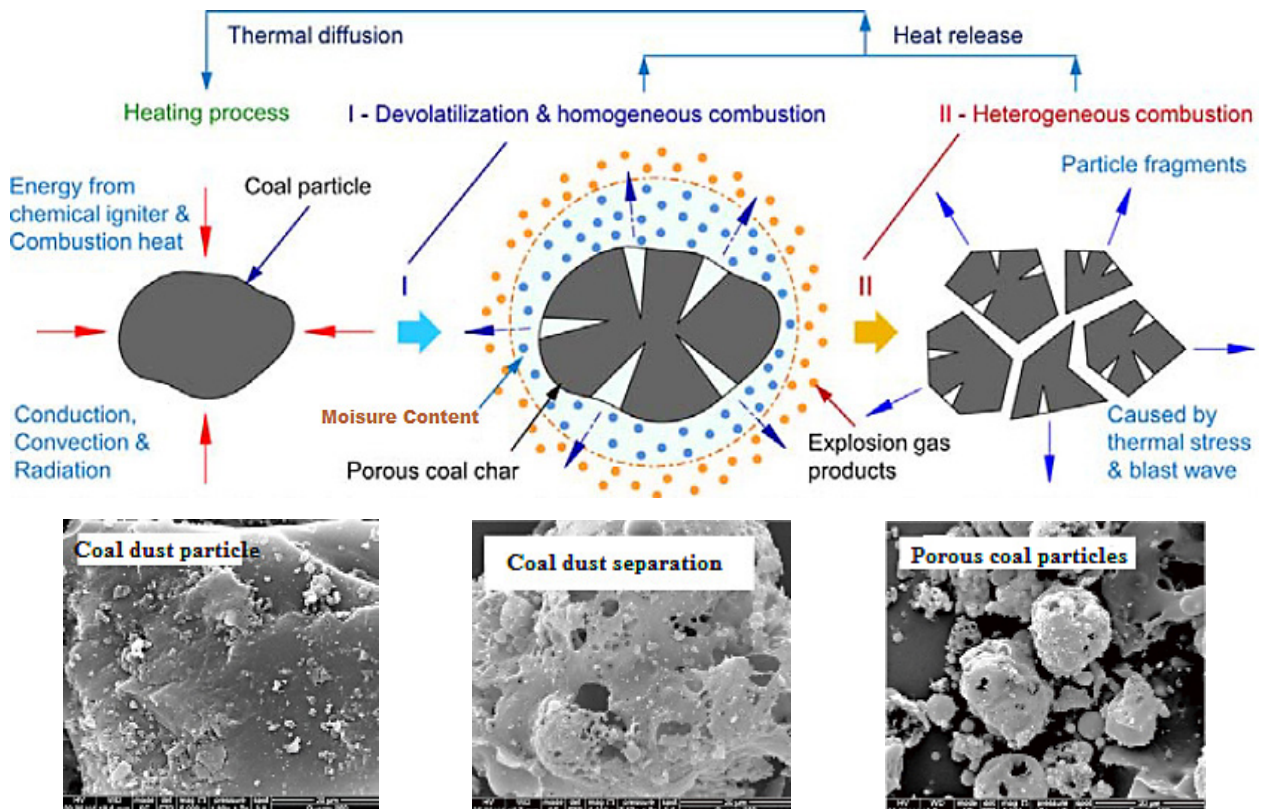

Figure 2: Changes in coal dust structure during the coal dust explosion process (Yuan et al., 2014).

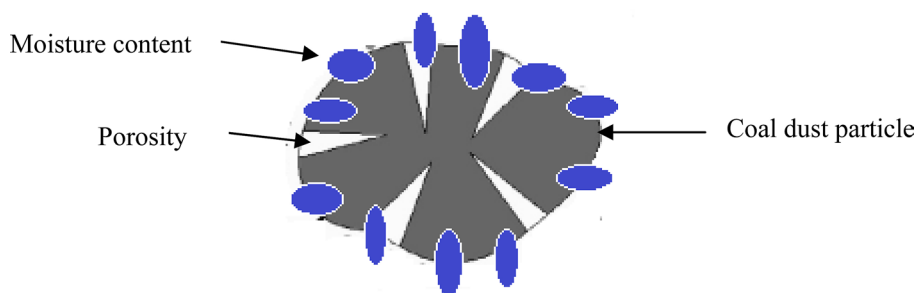

Figure 3: View of the moisture content on the surface of coal dust particles (Saffari et al., 2019a).

sensitivity. **Beamish et al. (2005)** and **Beamish et al. (2011)** also studied the effect of humidity on spontaneous combustion. Their study showed that the effect of moisture on spontaneous combustion at a given time depends on the amount of moisture in the coal sample. **Yuan et al. (2014)** studied the humidity of the three coal dust particle sizes. According to their results, the maximum explosion pressure decreases sharply with an increasing humidity curve turning point. As the moisture content increases, the dust particles stick together and are no longer flammable. **Wu et al., (2016)** also suggest that higher humidity reduces the explosion pressure. In addition, the results showed that the minimum ignition temperature (MIT) increased with increasing moisture content.

Therefore, the study of the moisture content changes is important in determining the explosion index. In the present study, the effect of moisture content of coal dust has been investigated on the explosion index of coal dust.

1.1. Explosion Intensity Parameters

According to **Table 1**, explosive intensity parameters consist of the maximum explosion pressure, the maxi-

imum rate of explosion pressure rise and the explosion index. The explosive parameters are usually measured inside a chamber through which the combustion is achieved at the center of a coarse coal dust cloud. The final pressure obtained in the test vessel is called the explosive pressure, used for a coal dust explosion (**Ogle, 2017**). The types of pressures involved in the coal dust explosion are shown in **Figure 4**. The maximum explosion pressure (P_{max}) is the maximum pressure obtained during the explosion test and is associated with the amount of heat released from the explosion. $(dp/dt)_{max}$ is the maximum rate of pressure rise, increasing during the explosion test. In fact, the amount of heat released from the explosion is shown by $(dp/dt)_{max}$. The explosion severity is shown by the explosion pressure. Greater explosion pressure may result in greater damage to the environment. The explosion pressure and the average temperature of the flame within the test chamber are directly related. The shape and volume of the test chamber must be limited to obtain an explosive pressure. The maximum pressure rise is highly affected by the size and shape of the test chamber (**Skjold, 2014**).

Equation 1 can be used to calculate the explosion index given the volume of the chamber and the maximum

Table 1: Important parameters in the description of coal dust explosion

Parameters	Unit	Parameter description	Industrial application
P_{max}	bar	The maximum explosion pressure in a fixed explosive volume	Containment, Venting, Suppression
$(dp/dt)_{max}$	bar/s	The maximum explosion pressure rise rate	Containment, Venting, Suppression
K_{St}	bar x m/s	explosion index	Containment, Venting, Suppression

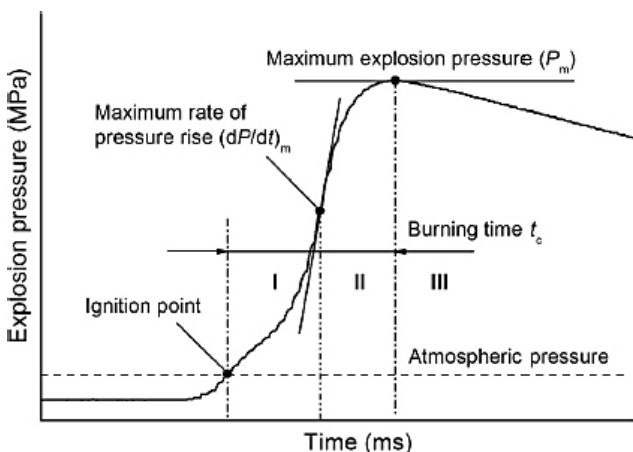

Figure 4: Profiles of various types of pressure in a coal dust explosion (**Li et al., 2018b**)

Table 2: Dust classification according to K_{St}

K_{St} bar x m/s	Dust class	Characteristic
0	St 0	No explosion
0-200	St 1	Weak explosion
200-300	St 2	Strong explosion
> 300	St 3	Very strong explosion

rate of pressure rise (**Dahoe et al., 1996**). Classification of the dust explosion capability index is shown in **Table 2**.

$$K_{St} = \left(\frac{dp}{dt} \right)_{max} \times V_0^{1/3} \tag{1}$$

where:

- V_0 - volume of the explosion sphere (m^3),
- $(dP/dt)_{max}$ - maximum rate of pressure rise (bar/s),
- K_{St} - explosion index (bar x m/s).

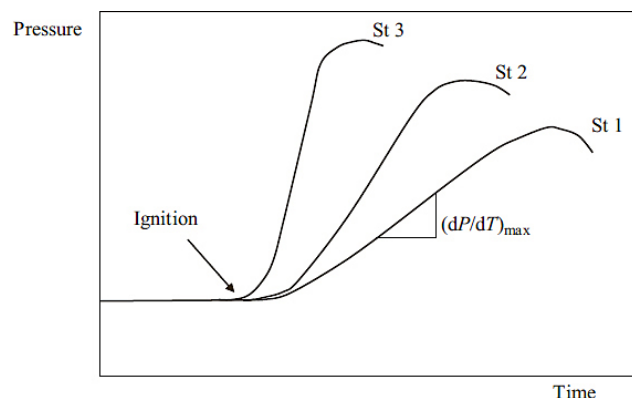
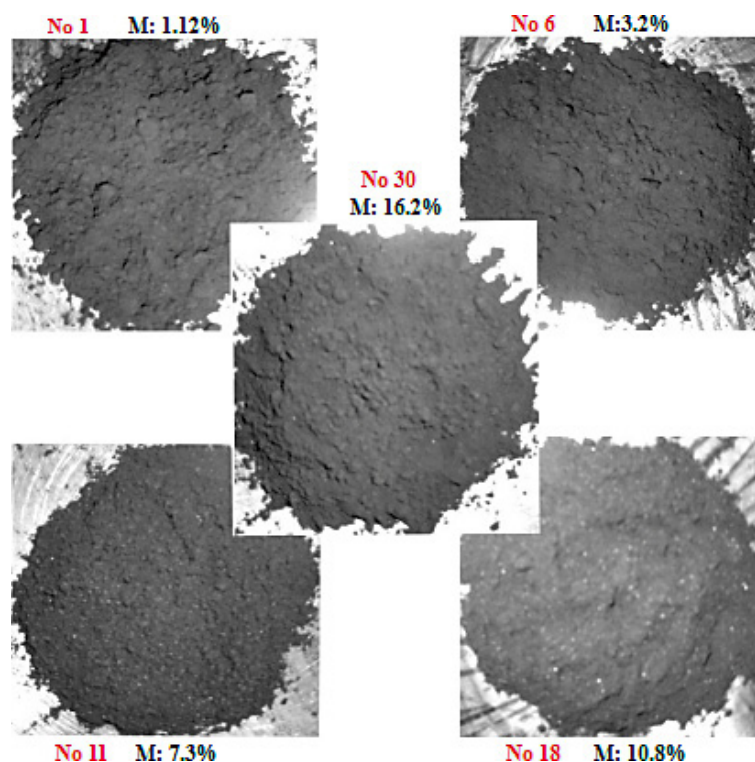

Figure 5: P Variation versus the time behavior with different St classes (**Wypych, 2001**).

Table 3: Results of moisture content of the tested coal samples

Number of Samples	Sampling location	(M%)	Number of Samples	Sampling location	(M%)
1	Tazare K ₅	1.12	17	Karsang	10
2	Tazare K ₅	1.2	18	Tazare K ₁₉	10.8
3	Tazare K ₁₉	1.27	19	Parvarde 1	10.9
4	Parvarde 2	2.8	20	Tazare K ₁₆	10.9
5	Tazare K ₅	3	21	Tazare K ₁₉	11.7
6	Parvarde 3	3.2	22	Goltut	11.9
7	Tazare K ₈	3.82	23	Tamuzare, D ₁₀	12.2
8	Mehmanduye	4.6	24	Karmand	12.3
9	Parvarde 2	5.53	25	Center Kalariz	13.4
10	Parvarde 2	6.19	26	Pabdana	14.1
11	Kerman	7.3	27	Mehmanduye	14.2
12	Mehmanduye	7.3	28	Hashoni	14.5
13	Parvarde 4	7.7	29	Tazare K ₂₅	14.9
14	Zirab	8	30	Takht, K ₁₀	16.2
15	Karsang	8.8	31	Gheshlagh, K ₃	24
16	Tazare K ₅	9.8	32	Takht, K ₈	25

**Figure 6:** Coal dust samples tested with different humidity

As can be seen in **Table 2**, a relative order for an explosion's severity is provided by these dust classes. Any dust, the K_{St} value of which is greater than 0 can be subjected to an explosion. Generally, the higher dust classes can cause stronger explosions. K_{St} is used for estimating the relative dust explosion severity, compared to other dusts. Considering the cubic law, it can be concluded that the maximum rate of pressure rise also changes in

accordance with the K_{St} class (see **Figure 5**) (Wypych, 2001).

2. Materials and methods

2.1. Samples preparation

For the purpose of this study, 32 coal samples were collected from different Iranian coal mines. These sam-

ples were crushed to a specified size (70 mesh), and the moisture content of each sample is determined using the oven according to ASTM D3173-11. Table 3 shows the results of the analysis of the moisture content (M%) of these 32 coal samples. Figure 6 shows the humidity of some of the samples tested.

2.2. Experimental apparatus

In this study, coal dust explosion tests were performed in a constant volume 2-litre chamber. The designed compartment is cylindrical and has a fuselage body and two heads of steel. The inside diameter and cylinder body height are 135 mm and the wall thickness is 40 mm. The two sides of the body are covered with quartz glass with a thickness of 80 mm and a diameter of 160 mm. Despite this glass, the chamber is capable of bearing pressures up to 100 bar. The purpose of placing the glass is to view the inside of the enclosure in order to investigate phenomena such as spraying and combustion. Two silicon seals are placed on both ends of the cylindrical body and two ends of the enclosure to prevent leakage of gases inside the enclosure and to prevent the entry of air outside during the vacuum creation. The combustion chamber used is shown in Figure 7.

The fuel spray nozzle is at the top of the chamber; this type of spray is a six-hole direct injection made by the Bush company. An air inlet and outlet that can be adjusted with a single valve are at the side of the enclosure. It is used to enter air prior to combustion and to discharge contents into the chamber after combustion. Table 4 presents the general specifications of the combustion chamber and the explosion-proof glass.

Figure 8 shows the layout designed to test the coal dust explosion. Two spray nozzles, a coal dust collector tank, two spark plug steel electrodes, a coil, a dynamic pressure sensor (PZ), a four band heater and a thermom-

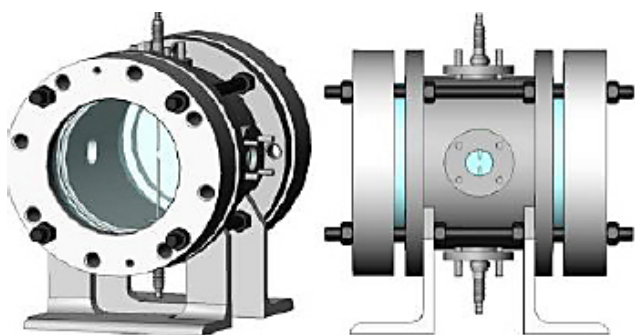

Figure 7: Fixed volume combustion chamber

eter are installed on the chamber. The light from the light source (a halogen lamp) is directed to the first spherical mirror (shown on the right) and collides with the second spherical mirror (on the left) after passing through the combustion chamber. The reflected light from this mirror enters the high-speed camera after passing through the knife edge. From the pipeline underneath the compartment, the air required for the enclosure is supplied and the smoke from the combustion goes out from the same direction. There are three pressure sensors (PT1, PT2, PT3) in this direction, and the pressure setting operation is performed with these sensors. The first pressure sensor (PT1) measures the vacuum pressure generated by the vacuum pump in the enclosure. Methane gas injection, spark ignition, and imaging start command are performed by a computer (electronic control unit). Liquid fuel and methane gas tanks shown in the figure are embedded outside the test room. As can be seen in this study, the Schlieren method was used to record combustion images. This method uses the principle of density difference. In this case, the combustion phenomenon can be investigated by light failure which occurs by passing a bunch of parallel light through the environment due to the difference in density created by fuel injection or combustion in the chamber. Figure 9 shows the actual view of the equipment used for testing the coal dust explosion.

2.3. Mixture Preparation

For the preparation of fuel and air mixture in the specified equivalence ratio, the partial pressure method of gases is used in ideal conditions (see Equation 2).

$$P_i = x_i \times P \quad (2)$$

Where:

P - pressure,

x_i is the molar fraction of i and l to n of the gases in the mixture.

Therefore, according to Equation 2, the pressure of each component will be obtained by multiplying the total pressure by the molar fraction (Moran, 2010). The mixture of gas for this test will be a mixture of methane and air, with its one-step reaction as follows:

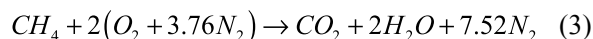

Tests for the steady-state mixture (equivalence ratio) at the initial pressure of 1.5 bar and at 25°C will be performed. To prepare the mixture for the desired conditions, it can be assumed that the ideal gas (due to low

Table 4: General specifications of the combustion chamber

Characteristics of the combustion chamber			Explosion proof glass specifications			
Type of compartment	Wall thickness	Inner diameter chamber	Type of glass	Ability to withstand pressure	Diameter of glass	Thickness of glass
Steel	40 mm	135 mm	quartz	100 bar	160 mm	80 mm

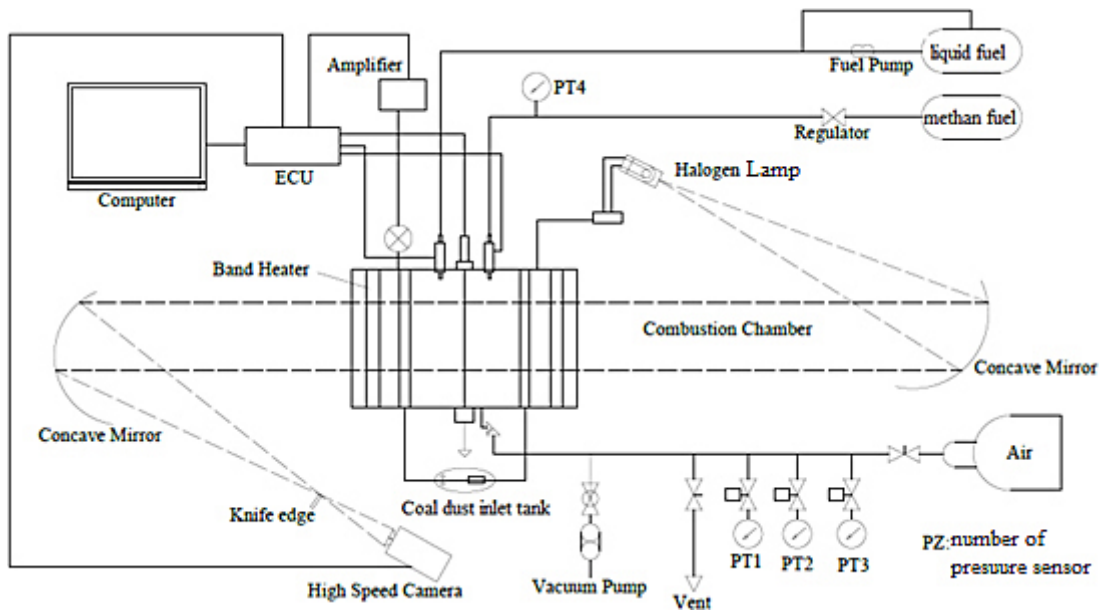

Figure 8: Schematic of the test layout

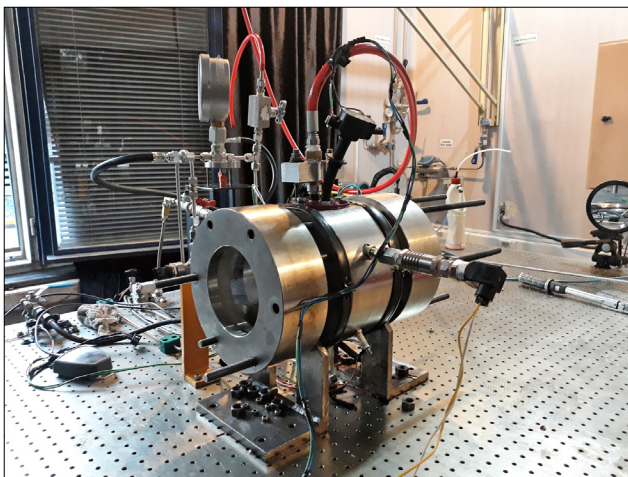

Figure 9: Real view of the equipment used in the coal dust explosion test

At the initial pressure of the chamber, the partial pressure of air and methane will be as described in **Table 5**:

Table 5: Results of partial pressures at the equivalence ratio of one

equivalence ratio	Primary total pressure (bar)	The partial pressure of methane (bar)	The partial pressure of air (bar)
1	1.492	0.142	1.35

To start the combustion of the methane and coal mixture, the mixture must be homogeneous. The homogenization process of the prepared mixture is illustrated in **Figure 10**. The interval between each image is 2 milliseconds (ms).

2.4. Measurements of explosive parameters

To record the explosion pressures and finally to calculate the explosion index, a pressure gauge according to **Figure 11** is used which can record pressure up to 10 bar. The pressure sensor used to record the pressure from combustion is manufactured by the Wika company in Germany and its accuracy is within the measurement range of $\pm 0.25\%$. The combustion pressure is fed into the software available on the computer via Data Logger.

After spraying the coal dust and methane gas into the chamber and homogenizing the mixture, the ignitor is ignited and after the necessary conditions for combustion, combustion takes place and the pressure and temperature of the combustion are recorded. Pressure of the combustion chamber increases after a certain period of time until it reaches its maximum point as the wall heat transfer coincides with the downward trend.

pressure and temperature) has a partial pressure for the gas injection rate, which can be calculated as **Equations 4 and 5**:

$$P_{CH_4} = y_{CH_4} \times P \quad (4)$$

$$P_{air} = y_{air} \times P \quad (5)$$

y is the molar fraction of chemical compounds which, in a stoichiometric state for methane in the mixture, is calculated by the **Equation 6** and is equal to 9.5%:

$$y_{CH_4} = \frac{n_{CH_4}}{n_t} = \frac{1}{10.52} = 0.095 \quad (6)$$

Where:

n_t - the mole number of gases in **Equation 3**

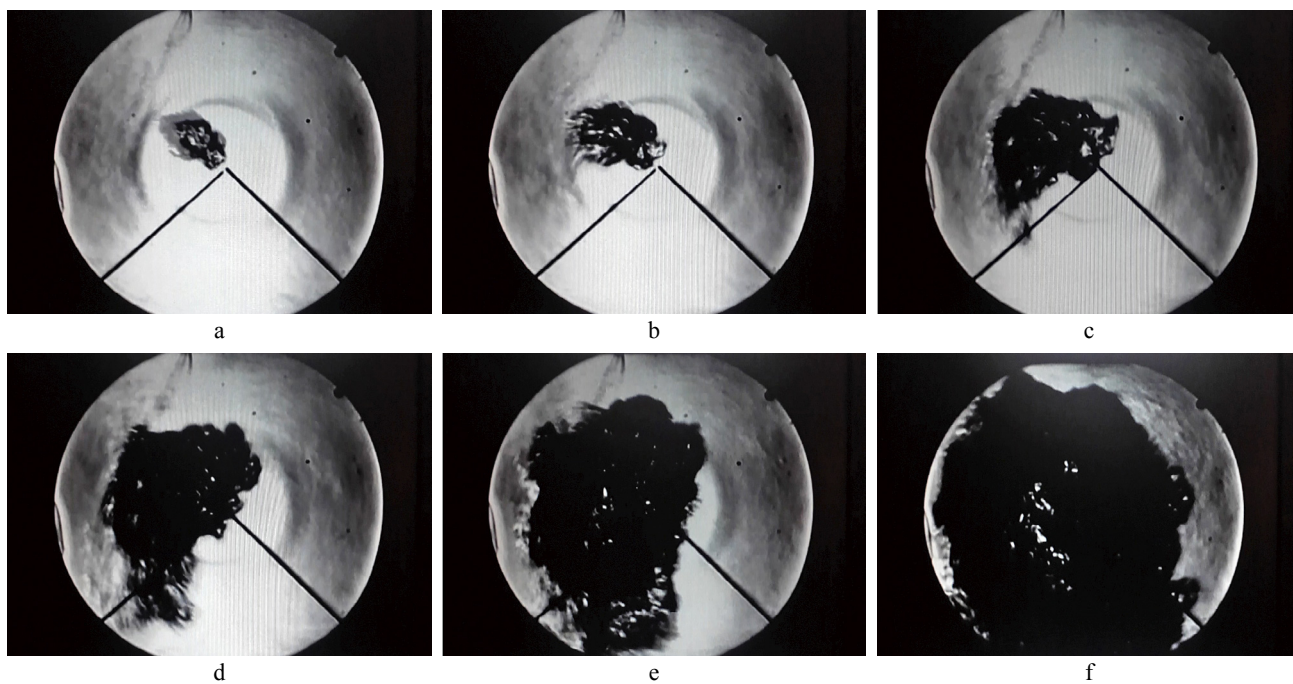

Figure 10: The process of homogenization of explosive mixtures tested

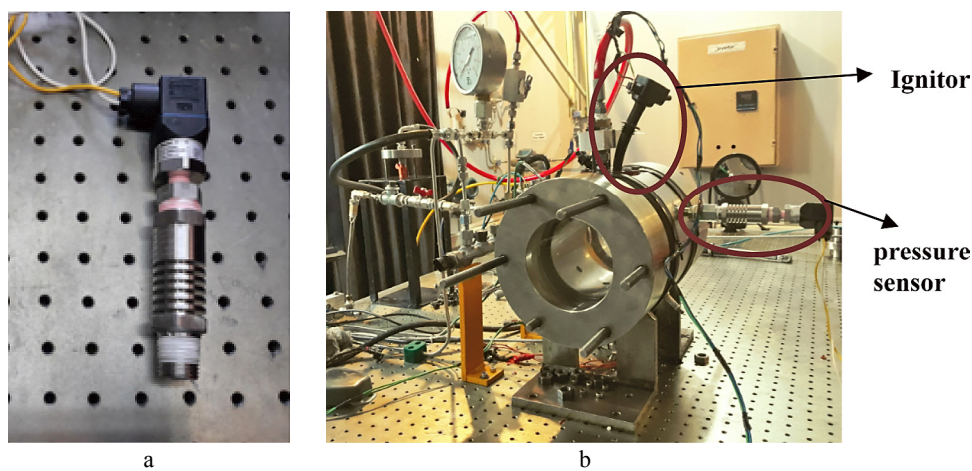

Figure 11: a) Pressure sensors used in coal dust explosion test; b) Pressure sensor mounted on the combustion chamber

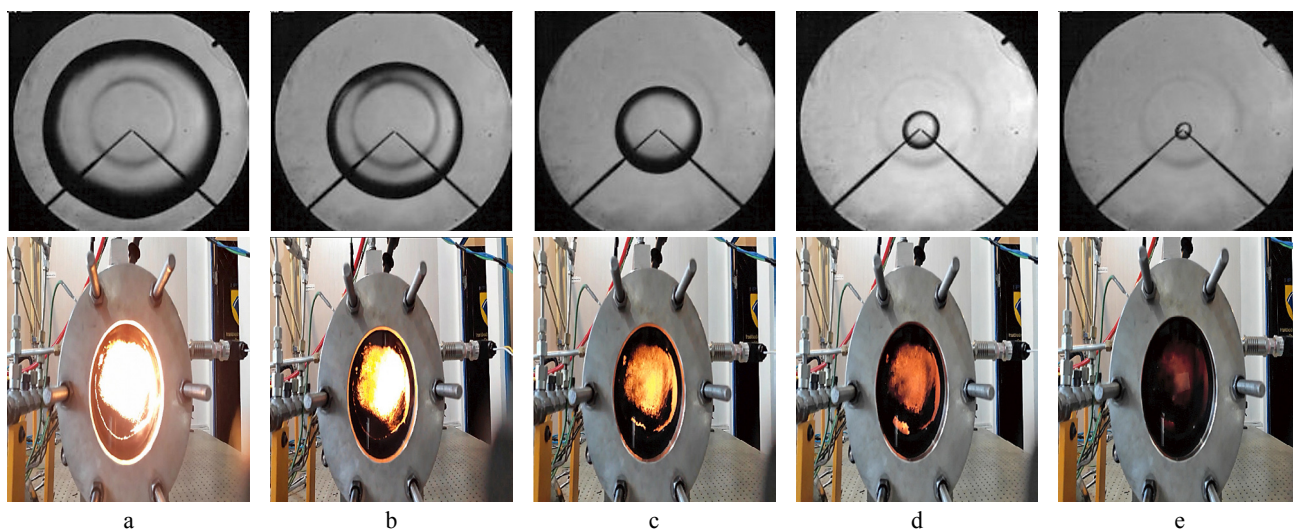

Figure 12: Spherical flame propagation process in each combustion cycle of methane and coal mixing

Table 6: The results of the test of coal dust explosions in a 2-litre chamber

Sample number	Explosive intensity parameters		
	P _{max} (bar)	(dp/dt) _{max} (bar/s)	K _{St} (bar×m/s)
1	7.66	3500	450.20
2	7.32	3260	419.33
3	7.49	3330	428.33
4	6.96	3012	387.43
5	7.28	3200	411.61
6	7.26	2950	379.46
7	6.70	2710	348.58
8	7.12	2889	371.61
9	6.80	2770	356.30
10	6.86	2779	357.46
11	6.85	2750	353.73
12	6.44	2643	339.97
13	6.65	2668	343.18
14	6.35	2585	332.50
15	6.22	2560	329.29
16	5.99	2527	325.05
17	5.96	2500	321.57
18	6.15	2544	327.23
19	5.89	2363	303.95
20	5.82	2291	294.69
21	6.20	2530	325.43
22	5.54	2150	276.55
23	5.63	2186	281.18
24	5.16	1983	255.07
25	5.27	2064	265.49
26	5.43	2110	271.41
27	5.50	2155	277.20
28	4.44	2100	270.12
29	4.79	1823	230.85
30	4.59	1635	212.02
31	3.44	905	116.40
32	3.89	850	109.33

The explosion process of coal dust in a 2-litre vessel was recorded by high speed photographs during a coal dust explosion as shown in **Figure 12**. The interval between each frame was 5 ms.

3. Modeling and discussion

To investigate the effect of coal dust on the explosive parameters, all experiments were carried out at a specific concentration (10000 g/m³). The variation of explosive parameters (P_{max} , $(dp/dt)_{max}$ and K_{ST}) of coal dust with moisture content tested on 32 coal dust samples is shown in **Table 6**.

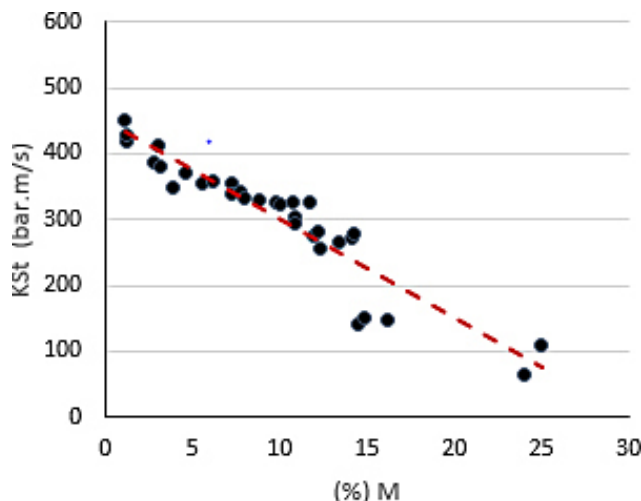
**Figure 13:** Variation of explosion index based on increased content of moisture

According to the data in **Table 6**, **Figure 13** shows the changes in the explosion index in terms of moisture content. As a result, the coal dust explosion index decreased as moisture increased.

In this study, linear and nonlinear regression analysis were used to predict the explosion index based on the intrinsic parameter of coal dust (moisture content). For determining the predictive models, the data on the moisture content of coal dust are divided into two categories of model training data and model test data. According to this categorization, 75% of the data was randomly assigned to training and 25% of the remaining data was used for the test. The equations resulting from multiple linear regression and the coefficient of determination (R^2) of each equation from SPSS software are presented in **Table 7**. In all the equations, the explosion index was considered as the dependent variable and the moisture content of coal dust, was considered as an independent parameter.

Table 7: Equations resulting from multivariate linear regression

Equation number	Relationship	R^2
1	$K_{St} = -12.95 M + 436.17$	0.86
2	$K_{St} = 391.897 - 0.705 M^2 - 0.705M$	0.79

In this study, the criteria of the root mean square error (RMSE), the proportion of variance accounted for (VAF), the mean absolute percentage error (MAPE) and the mean absolute error (MAE) were used to evaluate the performances of models. These criteria are expressed in **Table 8**.

Where:

n is the number of data;

Y_{meas} and Y_{Est} are measured and estimated values;

var is the variances of measured and predicted values.

Table 8: Statistical tests used to compare fitness estimates (Saffari et al., 2019b)

Statistical parameter	Equation	Description
Root Mean Square Error (RMSE)	$RMSE = \sqrt{\frac{1}{n} \times \sum_{i=1}^n (Y_{Meas} - Y_{Esti})^2}$	A smaller value means better fitness (Ideal =0).
Variance Accounted For (VAF)	$VAF = \left[1 - \frac{\text{var}(Y_{Meas} - Y_{Esti})}{\text{var}(Y_{Meas})} \right] \times 100$	A bigger value means better fitness (Ideal=100).
Mean Absolute Percentage Error (MAPE)	$MAPE = \frac{1}{n} \sum_{i=1}^n \left \frac{Y_{Meas} - Y_{Esti}}{Y_{Meas}} \right \times 100$	A smaller value means better fitness (Ideal =0).
Mean Absolute Error (MAE)	$MAE = \frac{1}{n} \times \left[\sum_{i=1}^n Y_{Meas} - Y_{Esti} \right]$	A smaller value means better fitness (Ideal =0).

Table 9: Values of evaluation indicators for regression relations

Equation number	Relationship	R ²	RMSE	VAF	MAPE	MAE
1	$K_{St} = -12.95 M + 436.17$	0.86	2.3	92.7%	2.6	9.25
2	$K_{St} = 391.897 - 0.705 M^2 - 0.705M$	0.79	6.02	87.17%	3.35	11.8

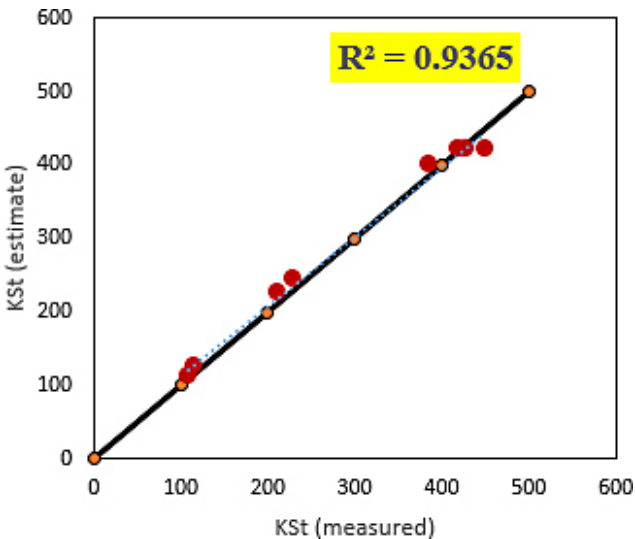

Figure 14: Comparison of measured and predicted values for relationship no.1 for testing data

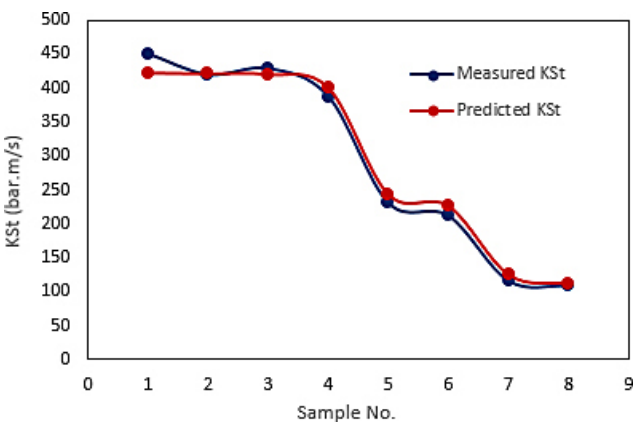

Figure 15: Comparison of the measured and predicted values of the K_{St} test method for testing data

The values of these criteria for the regression equations are presented in **Table 9**.

A comparison of the evaluation indicators provided for each relationship showed higher values of R² and VAF and the lower rates of MAPE, MAE and RMSE for the relationship of $K_{St} = -12.95 M + 436.17$.

Figure 14 shows the relationship between the predicted and measured values for relationship no. 1 and their status relative to the line bisector for testing data.

Figure 15 shows the relationship between the measured and predicted values, with a good coefficient of determination (R²), obtained from the prediction models. A value of R² close to one shows a good fit of the prediction model, and a value close to zero represents a poor fit.

4. Conclusions

After studying many articles on coal explosion, it was found that humidity is an important parameter in coal explosion capability. In this study, the effect of this parameter was investigated on the predictability of coal dust explosions. Therefore, in this study, 32 samples of coal dust with different moisture content were collected from different coal mines throughout Iran and their explosiveness was investigated in the combustion chamber. Then, using a regression analysis method, a model was presented to predict the explosion index based on the moisture parameter and then, 8 coal dust samples were randomly selected to validate the regression model. Based on the observations of the present study, the following conclusions are drawn:

- 1 – As moisture increases, the maximum explosion pressure and the maximum rate of increase in

pressure decrease slowly and linearly. If the moisture content exceeds the permitted level, the dust will not ignite.

- 2 – At low humidity, moisture mainly consumes heat released from the coal dust blast, and with increasing moisture, the explosion index decreases.
- 3 – The presence of moisture in addition to heat consumption causes the coal particles to accumulate, thereby increasing the size of the effective coal dust particles and weakening the dust cloud dispersion so that the explosion index is dramatically reduced.
- 4 – The criteria of the root mean square error (RMSE), the proportion of variance accounted for (VAF), the mean absolute percentage error (MAPE) and the mean absolute error (MAE) were used to determine the most suitable equation from the presented equations. The lowest level (RMSE), (MAPE), (MAE) and the maximum value of (VAF), are related to the relationship $K_{st} = -12.95M + 436.17$
- 5 – The results show that moisture should be considered in coal mines due to the severe impact and complex behavior of moisture in coal explosions. Also, the present investigation will advance the improvement of methodologies to manage coal dust explosions in underground coal mines.

5. References

- Ajrash, M.J., Zanganeh, J., Eschebach, D., Kundu, S. and Moghtaderi, B. (2015): Effect of Methane and coal dust Concentrations on Explosion Pressure Rise. *Proceedings of the Australian Combustion Symposium (ACS)*, Editors: Yi Yang, Nigel Smith, University of Melbourne, 252-255.
- Ajrash, M.J., Zanganeh, J. and Moghtaderi, B. (2017): The effects of coal dust concentrations and particle sizes on the minimum auto-ignition temperature of a coal dust cloud. *Fire and Materials*, 41, 7, 908-915.
- ASTM D3173–11. (2017): Standard Test Method for Moisture in the Analysis Sample of Coal and Coke, ASTM International, West Conshohocken, PA, <https://www.astm.org>.
- Beamish, B.B. and Beamish, R. (2011): Experience with using a moist coal adiabatic oven testing method for spontaneous combustion assessment. 11th Underground Coal Operators' Conference, University of Wollongong and the Australasian Institute of Mining and Metallurgy. 380-384.
- Beamish, B.B. and Hamilton, G.R. (2005): Effect of moisture content on the R_{70} self- heating rate of callide coal. *International Journal of Coal Geology*, 64, 133-138.
- Bi, M.S and Wang, H.Y. (2008): Experiment on methane--coal dust explosions. *Journal of China Coal Society*, 33, 784-788.
- Cao, W., Qin, Q., Cao, W., Lan, Y., Chen, T., Xu, S. and Cao, X. (2017): Experimental and numerical studies on the explosion severities of coal dust/air mixtures in a 20-L spherical vessel. *Powder Technology*, 310, 17-23.
- Dahoe, A.E., Zevenbergen, J.F., Verheijen, P.J.T., Lemkowitz, S.M., and Scarlett, B. (1996): Dust explosions in spherical vessels: Prediction of the pressure evolution and determination of the burning velocity and flame thickness. *Journal of Loss Prevention in the Process Industries*, 9, 33-44.
- Garcia-Torrent, J., Nieves Fernandez-Anez, N., Medic-Pejic, L., Blandon-Montes, A. and Molina-Escobar, J.M. (2016): Ignition and explosion parameters of Colombian coals. *Journal of Loss Prevention in the Process Industries*, 43, 706-713.
- Hao, Q.M. and Li, X.M. (2011): Discussion on coal mining accidents & explosions. *Coal* 20, 43.
- Hu, S.Q., Yu, C.J. and Tan, Y.X. (2010): Experimental research on secondary explosion coal dust detonated by gas explosion in pipeline. *Journal of Basic Science and Engineering*, 18, 895.
- Kucuk, A., Kadioglu, Y. and Gulaboglu, M.S. (2003): A study of spontaneous combustion characteristics of a turkish lignite: particle size, moisture of coal, humidity of air. *Combustion and Flame*, 133, 255-261.
- Li, Q., Tao, Q., Yuan, C., Zheng Y., Zhang G. and Liu, J. (2018a): Investigation on the structure evolution of pre and post explosion of coal dust using X-ray diffraction. *International Journal of Heat and Mass Transfer*, 120, 1162- 1172.
- Li, Q., Yuan, C., Tao, Q., Zheng, Y. and Zhao, Y. (2018b): Experimental analysis on post-explosion residues for evaluating coal dust explosion severity and flame propagation behaviors. *Fuel*, 215, 417-428.
- Moradi, H., Sereshki, F., Ataei M. and Nazari M. (2019): Experimental study of the effects of particle size of coal dust on laminar burning velocity in mixture of coal dust and methane. *Rudarsko--geološko--naftni zbornik (The Mining-Geology-Petroleum Engineering Bulletin)*, 47, DOI: 10.17794/rgn.2019.4.9.
- Moran, M.J., Shapiro H.N., Boettner, D.D. and Bailey, M.B. (2010): *Fundamentals of engineering thermodynamics*. Wiley New York, 705-775, 1004 p
- Ogle, R.A. (2017): *Dust Explosion Dynamics*. Elsevier, Amsterdam, 686 p.
- Ranganathan, S., Petrow, D., Rockwell, S.R. and Rangwala, A. (2018): Turbulent burning velocity of methane-air--dust premixed flames. *Combustion and Flame*, 188, 367–375.
- Russo, P. and Benedetto, D.A. (2013): Review of a dust explosion modeling. *Chemical Engineering Transactions*, 31, 955-960.
- Saffari, A., Sereshki, F. and Ataei M. (2019a): The simultaneous effect of moisture and pyrite on coal spontaneous combustion using CPT and R70 test methods. *Rudarsko-geološko-naftni zbornik (The Mining-Geology-Petroleum Engineering Bulletin)*, 46, 7, DOI: 10.17794/rgn.2019.3.1.
- Saffari, A., Sereshki, F. and Ataei M. (2019b): Examination of the role of moisture content on the spontaneous combustion of coal (SCC). *Rudarsko geološko- naftni zbornik (The Mining-Geology-Petroleum Engineering Bulletin)*, 46, 8, DOI: 10.17794/rgn.2019.3.7
- Skjold, T. (2014): *Flame propagation in dust clouds Numerical simulation and experimental investigation*. University of Bergen, Norway, 57p.

- Wypych, P. (2001): Dust explosion hazard considerations for materials handling plants. In: A. Levy, H. Kalman (Eds.), Handbook of Conveying and Handling of Particulate Solids, Elsevier, Amsterdam. 745-752, 870 p.
- Wu, D., Norman, F., Verplaetsen, F. and Bulck, E. (2016): Experimental study on the minimum ignition temperature of coal dust clouds in oxy-fuel combustion atmospheres. Journal of Hazard Material, 307, 274-280.
- Yu, H. T., He, Y. H. and Dong, J. (2012): Experimental study on the minimum explosive mass concentration of AP/Al/ferrocene mixed system. Beijing Institute of Technology, 32, 1211-1214.
- Yuan, J., Wei W., Huang, W., Du, B., Liu, L. and Zhu J. (2014): Experimental investigations on the roles of moisture in coal dust explosion. Journal of the Taiwan Institute of Chemical Engineers, 45, 2325-2333.
- Zhang, Y.S., Han, L.L. and Wang, L. (2009): Mechanism research of gas and coal dust explosion. Journal of Coal Science and Engineering, 15, 171-174.

SAŽETAK

Procjena utjecaja sadržaja vlage u ugljenoj prašini na predviđanje indeksa njezine eksplozivnosti

Istraživanje eksplozivnosti ugljene prašine iznimno je važno kod razvoja sigurnosnih tehnika za sprječavanje eksplozije ugljene prašine. Indeks eksplozivnosti koristi se za procjenu težine (snage) eksplozije. Pri tomu je sadržaj vlage jedna od intrinzičkih varijabli same prašine izravno rabljena za izračun indeksa. U istraživanju su analizirana 32 uzorka različitoga sadržaja vlage prikupljena u različitim iranskim rudnicima. Eksplozivnost prašine ispitana je u dvolitarskim zatvorenim komorama. Određeni su najvažniji, tj. najrizičniji, parametri kojima se predviđa indeks eksplozivnosti uporabom linearne regresije. Skup od 75 % podataka, slučajno odabranih, uporabljen je za uvježbavanje, a 25 % za provjeru. Kvaliteta modela ispitana je korijenom srednje kvadratne pogreške, udjelom varijance, srednjom apsolutnom postotnom i srednjom apsolutnom pogreškom. Uspoređeni su rezultati laboratorijskoga testiranja i oni linearne regresijske analize.

Ključne riječi:

eksplozija ugljene prašine, indeks eksplozivnosti, sadržaj vlage, zatvorena komora, intenzitet eksplozije, regresijska analiza

Authors contribution

Hadis Moradi (Ph.D. Candidate): initialized the idea, completed literature review and participated in all work stages, such as providing coal samples, running experimental tests and data analyses. **Farhang Sereshki** (Full Professor): executed experimental tests, data analysis, tested its accuracy, and helped with field work. **Mohammad Ataei** (Full Professor): managed the whole process and supervised it from the beginning to the end. **Mohsen Nazari** (Associate Professor) tested the device, finalized the device and helped with field work.